

Allen-Bradley

SLC 500 RTD/Resistance Input Module

1746-NR4

User Manual

**Rockwell
Automation**

Important User Information

Solid state equipment has operational characteristics differing from those of electromechanical equipment. Safety Guidelines for the Application, Installation and Maintenance of Solid State Controls (publication SGI-1.1 available from your local Rockwell Automation sales office or online at <http://literature.rockwellautomation.com>) describes some important differences between solid state equipment and hard-wired electromechanical devices. Because of this difference, and also because of the wide variety of uses for solid state equipment, all persons responsible for applying this equipment must satisfy themselves that each intended application of this equipment is acceptable.





In no event will Rockwell Automation, Inc. be responsible or liable for indirect or consequential damages resulting from the use or application of this equipment.

The examples and diagrams in this manual are included solely for illustrative purposes. Because of the many variables and requirements associated with any particular installation, Rockwell Automation, Inc. cannot assume responsibility or liability for actual use based on the examples and diagrams.

No patent liability is assumed by Rockwell Automation, Inc. with respect to use of information, circuits, equipment, or software described in this manual.

Reproduction of the contents of this manual, in whole or in part, without written permission of Rockwell Automation, Inc., is prohibited.

Throughout this manual, when necessary, we use notes to make you aware of safety considerations.

<p>WARNING</p> 	<p>Identifies information about practices or circumstances that can cause an explosion in a hazardous environment, which may lead to personal injury or death, property damage, or economic loss.</p>
<p>IMPORTANT</p>	<p>Identifies information that is critical for successful application and understanding of the product.</p>
<p>ATTENTION</p> 	<p>Identifies information about practices or circumstances that can lead to personal injury or death, property damage, or economic loss. Attentions help you identify a hazard, avoid a hazard, and recognize the consequence</p>
<p>SHOCK HAZARD</p> 	<p>Labels may be on or inside the equipment, for example, a drive or motor, to alert people that dangerous voltage may be present.</p>
<p>BURN HAZARD</p> 	<p>Labels may be on or inside the equipment, for example, a drive or motor, to alert people that surfaces may be dangerous temperatures.</p>

New Information

The information below summarizes the changes to this manual since the last revision.

The table below lists sections that document new features and additional information about existing features and shows where to find this new information.

Change	Page
Moved terms and abbreviations from Preface to Glossary.	Preface
Updated programming examples to show RSLogix 500 software.	Throughout manual
Updated programming examples.	Chapter 6
Updated programming examples.	Chapter 8
Added Appendix D, I/O configuration.	Appendix D, page 131

Notes:

	Preface	
	Use This Manual	7
	Who Should Use This Manual	7
	Purpose of This Manual.	7
	Common Techniques Used in This Manual.	9
	Chapter 1	
Overview	Description	11
	System Overview	18
	Chapter 2	
Quick Start Guide	Required Tools and Equipment	23
	Procedures	24
	Chapter 3	
Install and Wire the Module	EMC Directive	33
	Electrostatic Damage	33
	NR4 Power Requirements	34
	Module Location in Chassis	35
	Module Installation and Removal	38
	Terminal Wiring	40
	Calibration	47
	Chapter 4	
Preliminary Operating Considerations	Module ID Code	51
	Module Addressing	52
	Channel Filter Frequency Selection	54
	Scanning Process and Channel Timing	58
	Channel Turn-on, Turn-off, and Reconfiguration Time	61
	Response to Slot Disabling	61
	Chapter 5	
Channel Configuration, Data, and Status	Channel Configuration	63
	Channel Configuration Procedure	64
	Channel Data Word.	81
	Channel Status Checking	82

Ladder Programming Examples	<p>Chapter 6</p> <p>Device Configuration 87</p> <p>Initial Programming. 88</p> <p>Dynamic Programming 91</p> <p>Verify Channel Configuration Changes. 92</p> <p>Interface to the PID Instruction 93</p> <p>Use the Proportional Counts Data Format with User-set Scaling. 95</p> <p>Monitor Channel Status Bits. 96</p> <p>Invoke Autocalibration 97</p> <p>Chapter 7</p> <p>Introduction 99</p> <p>Module Operation vs. Channel Operation 99</p> <p>Power Turn-on Diagnostics 100</p> <p>Channel Diagnostics 100</p> <p>LED Indicators 100</p> <p>Error Codes 102</p> <p>Replacement Parts. 106</p> <p>Contact Rockwell Automation 106</p> <p>Chapter 8</p> <p>Basic Example 107</p> <p>Supplementary Example 111</p> <p>Appendix A</p> <p>Module Accuracy 119</p> <p>Appendix B</p> <p>. 123</p> <p>Appendix C</p> <p>Channel Configuration Procedure 125</p> <p>Appendix D</p> <p>. 131</p> <p>Glossary</p> <p>Index</p>
Module Diagnostics and Troubleshooting	
Application Examples	
Specifications	
RTD Standards	
Configuration Worksheet for RTD/Resistance Module	
I/O Configuration	

Use This Manual

Read this preface to familiarize yourself with the rest of the manual. This preface covers the following topics:

- Who should use this manual
- Purpose of this manual
- Terms and abbreviations
- Conventions used in this manual
- Allen-Bradley support

Who Should Use This Manual

Use this manual if you are responsible for designing, installing, programming, or troubleshooting control systems that use Allen-Bradley small logic controllers.

You should have a basic understanding of SLC 500 products. You should understand programmable controllers and be able to interpret the ladder logic instructions required to control your application. If you do not, contact your local Allen-Bradley representative for information on available training courses before using this product.

Purpose of This Manual

This manual is a reference guide for the 1746-NR4 RTD/Resistance Input Module. The manual:

- gives you an overview of system operation.
- explains the procedures you need to install and wire the module at the application site.
- provides ladder programming examples.
- provides an application example of how this input module can be used to control a process.

Contents of this Manual

Chapter	Title	Contents
	Preface	Describes the purpose, background, and scope of this manual. Also specifies the audience for whom this manual is intended and defines key terms and abbreviations used throughout this book.
1	Overview	Provides a hardware and system overview. Explains and illustrates the theory behind the RTD input module.
2	Quick Start Guide	Provides a general procedural roadmap to help you get started using the RTD module.
3	Install and Wire	Provides installation procedures and wiring guidelines.
4	Preliminary Operating Considerations	Gives you the background information you need to understand how to address and configure the module for optimum operation as well as how to make changes once the module is in a run state.
5	Channel Configuration, Data, and Status	Examines the channel configuration word and the channel status word bit by bit, and explains how the module uses configuration data and generates status during operation.
6	Ladder Programming Examples	Gives an example of the ladder logic required to define the channel for operation. Also includes representative examples for unique programming requirements such as PID.
7	Module Diagnostics and Troubleshooting	Explains how to interpret and correct problems with your RTD module.
8	Application Examples	Examines both basic and supplementary applications and gives examples of the ladder programming necessary to achieve the desired result.
Appendix A	Specifications	Provides physical, electrical, environmental, and functional specifications for the RTD module.
Appendix B	RTD Standards	Provides physical, electrical, environmental, and functional specifications for the RTD and potentiometer.
Appendix C	Configuration Worksheet for RTD/Resistance Module	Provides a worksheet to help you configure the module for operation.
Appendix D	I/O Configuration	Contains information on the I/O configuration procedure for RSLogix 500 Version 6.0 and later software.

Additional Resources

The following documents contain additional information on Rockwell Automation products.

For	Read This Document	Document Number
An overview of the SLC 500 family of products	SLC 500 Systems Selection Guide	1747-SG001
A description on how to install and use your modular SLC 500 programmable controller	SLC 500 Module Hardware Style User Manual	1747-UM011
A description on how to install and use your fixed SLC 500 programmable controller	Installation & Operation Manual for Fixed Hardware Style Programmable Controllers	1747-UM009
A reference manual that contains status file data, instruction set, and troubleshooting information.	SLC 500 Instruction Set Reference Manual	1747-RM001
A resource manual and user's guide containing information about the analog modules used in your SLC 500 system.	SLC 500 4-Channel Analog I/O Modules User's Manual	1746-UM005
In-depth information on grounding and wiring Allen-Bradley programmable controllers	Industrial Automation Wiring and Grounding Guidelines	1770-IN041
A description of important differences between solid-state programmable controller products and hard-wired electromechanical devices	Application Considerations for Solid-State Controls	SGI-IN001
A glossary of industrial automation terms and abbreviations	Allen-Bradley Industrial Automation Glossary	AG-QR071
An article on wire sizes and types for grounding electrical equipment	National Electrical Code	Published by the National Fire Protection Association of Boston, MA

Common Techniques Used in This Manual

The following conventions are used throughout this manual:

- Bulleted lists such as this one provide information, not procedural steps.
- Numbered lists provide sequential steps or hierarchical information.
- Text in `this` font indicates words or phrases you should type.

Notes:

Overview

This chapter describes the four-channel 1746-NR4 RTD/Resistance Input Module and explains how the SLC controller gathers RTD (Resistance Temperature Detector) temperature or resistance-initiated analog input from the module. Included is:

- a general description of the module's hardware and software features.
- an overview of system operation.

For the rest of the manual, the 1746-NR4 RTD/Resistance Input Module is referred to as simply the RTD module.

Description

The RTD module receives and stores digitally converted analog data from RTD units or other resistance inputs such as potentiometers into its image table for retrieval by all fixed and modular SLC 500 processors. An RTD module consists of a temperature-sensing element connected by two, three, or four wires that provide input to the RTD module. The module supports connections from any combination of up to four RTD units of various types (for example: platinum, nickel, copper, or nickel-iron) or other resistance inputs.

The RTD module supplies a small current to each RTD unit connected to the module inputs (up to 4 input channels). The module provides on-board scaling and converts RTD unit input to temperature (°C, °F) or reports resistance input in ohms.

Each input channel is individually configurable for a specific input device. Broken sensor detection (open- or short-circuit) is provided for each input channel. In addition, the module provides indication if the input signal is out-of-range.

For more detail on module functionality refer to System Overview page 18.

Simplified RTD Module Circuit

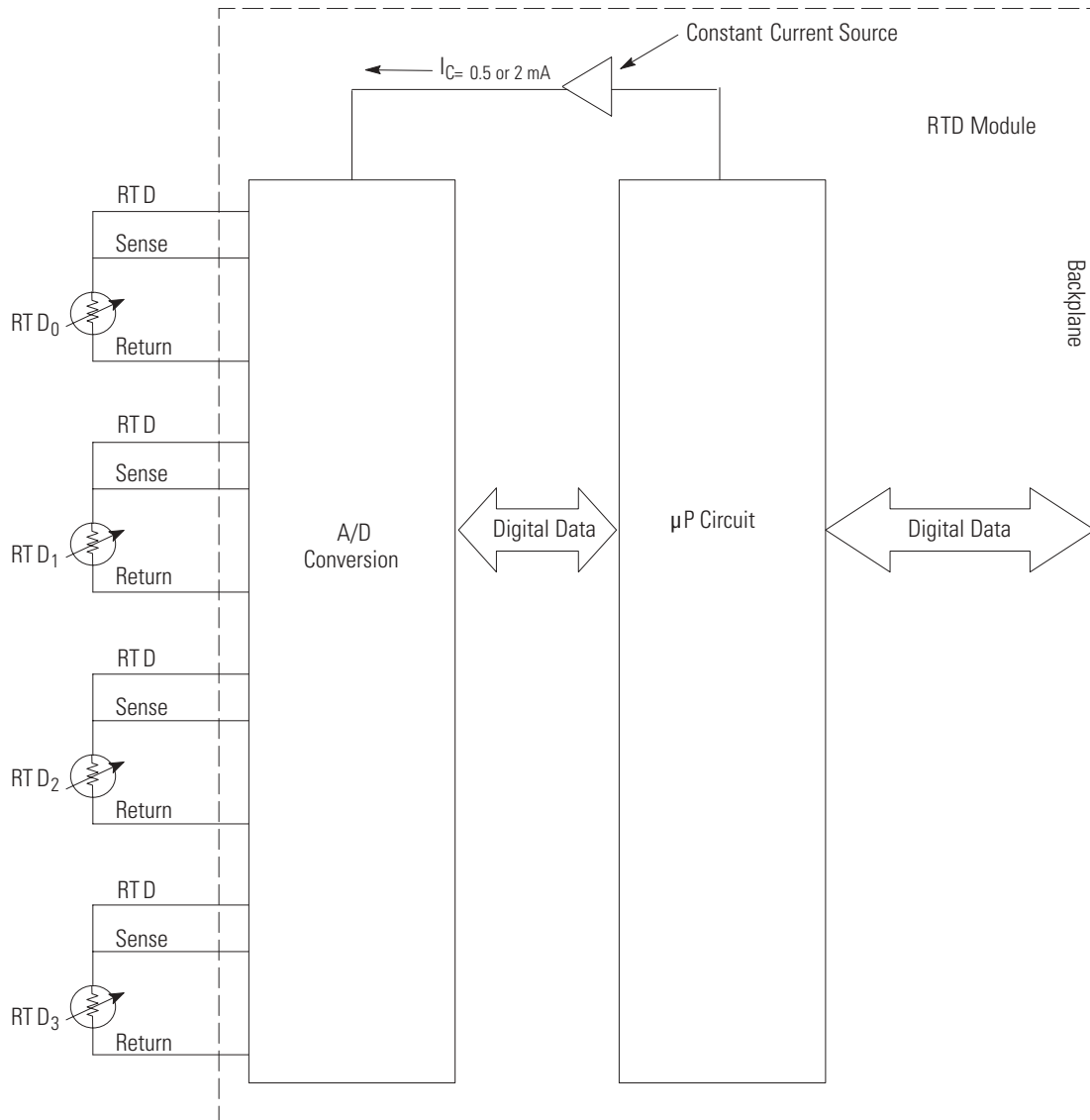

RTD Compatibility

The following table lists the RTD types you can use with the RTD module and gives each type's associated temperature range, resolution, and repeatability specifications.

RTD Unit Temperature Ranges, Resolution and Repeatability

RTD Unit Type		Temperature Range (0.5 mA excitation) ⁽¹⁾	Temperature Range (2.0 mA excitation) ⁽¹⁾	Resolution	Repeatability
Platinum (385) ⁽²⁾	100 Ω	-200...850 °C (-328...1562 °F)	-200...850 °C (-328...1562 °F)	0.1 °C (0.2 °F)	± 0.2 °C (± 0.4 °F)
	200 Ω	-200...850 °C (-328...1562 °F)	-200...850 °C (-328...1562 °F)	0.1 °C (0.2 °F)	± 0.2 °C (± 0.4 °F)
	500 Ω	-200...850 °C (-328...1562 °F)	-200...850 °C (-328...1562 °F)	0.1 °C (0.2 °F)	± 0.2 °C (± 0.4 °F)
	1000 Ω	-200...850 °C (-328...1562 °F)	-200...240 °C (-328...464 °F)	0.1 °C (0.2 °F)	± 0.2 °C (± 0.4 °F)
Platinum (3916) ⁽²⁾	100 Ω	-200...630 °C (-328...1166 °F)	-200...630 °C (-328...1166 °F)	0.1 °C (0.2 °F)	± 0.2 °C (± 0.4 °F)
	200 Ω	-200...630 °C (-328...1166 °F)	-200...630 °C (-328...1166 °F)	0.1 °C (0.2 °F)	± 0.2 °C (± 0.4 °F)
	500 Ω	-200...630 °C (-328...1166 °F)	-200...630 °C (-328...1166 °F)	0.1 °C (0.2 °F)	± 0.2 °C (± 0.4 °F)
	1000 Ω	-200...630 °C (-328...1166 °F)	-200...630 °C (-328...446 °F)	0.1 °C (0.2 °F)	± 0.2 °C (± 0.4 °F)
Copper (426) ⁽²⁾⁽³⁾	10 Ω	Not allowed ⁽⁴⁾	-100...260 °C (-148...500 °F)	0.1 °C (0.2 °F)	± 0.2 °C (± 0.4 °F)
Nickel (618) ⁽²⁾⁽⁵⁾	120 Ω	-100...260 °C (-148...500 °F)	-100...260 °C (-148...500 °F)	0.1 °C (0.2 °F)	± 0.1 °C (± 0.2 °F)
Nickel (672) ⁽²⁾	120 Ω	-80...260 °C (-112...500 °F)	-80...260 °C (-112...500 °F)	0.1 °C (0.2 °F)	± 0.1 °C (± 0.2 °F)
Nickel Iron (518) ⁽²⁾	604 Ω	-100...200 °C (-148...392 °F)	-100...200 °C (-148...392 °F)	0.1 °C (0.2 °F)	± 0.1 °C (± 0.2 °F)

⁽¹⁾ The temperature range for the 1000 Ω RTD is dependant on the excitation current.

⁽²⁾ The digits following the RTD type represent the temperature coefficient of resistance (α), which is defined as the resistance change per ohm per °C. For instance, Platinum 385 refers to a platinum RTD with $\alpha = 0.00385 \Omega/\Omega\text{-}^\circ\text{C}$ or simply $0.00385 /^\circ\text{C}$.

⁽³⁾ Actual value at 0 °C (32 °F) is 9.042 Ω per SAMA standard RC21-4-1966.

⁽⁴⁾ To maximize the relatively small RTD unit signal, only 2 mA excitation current is allowed.

⁽⁵⁾ Actual value at 0 °C (32 °F) is 100 Ω per DIN standard.

IMPORTANT

The exact signal range valid for each input type is dependent upon the excitation current magnitude that you select when configuring the module.

For details on excitation current, refer to page 119.

This table shows the accuracy and temperature drift.

Accuracy and Temperature Drift Specifications

RTD Unit Type		Accuracy (0.5 mA excitation) ⁽¹⁾	Accuracy (0.2 mA excitation) ⁽¹⁾	Temperature Drift (0.5 mA excitation) ⁽²⁾	Temperature Drift (0.2 mA excitation) ⁽²⁾
Platinum (385) ⁽³⁾	100 Ω	±0.1 °C (±2.0 °F)	±0.5 °C (±0.9 °F)	±0.034 °C/°C (±0.061 °F/°F)	±0.014 °C/°C (±0.025 °F/°F)
	200 Ω	±0.1 °C (±2.0 °F)	±0.5 °C (±0.9 °F)	±0.034 °C/°C (±0.061 °F/°F)	±0.014 °C/°C (±0.025 °F/°F)
	500 Ω	±0.6 °C (±1.1 °F)	±0.5 °C (±0.9 °F)	±0.017 °C/°C (±0.031 °F/°F)	±0.014 °C/°C (±0.025 °F/°F)
	1000 Ω	±0.6 °C (±1.1 °F)	±0.5 °C (±0.9 °F)	±0.017 °C/°C (±0.031 °F/°F)	±0.014 °C/°C (±0.025 °F/°F)
Platinum (3916) ⁽³⁾	100 Ω	±1.0 °C (±2.0 °F)	±0.4 °C (±0.7 °F)	±0.034 °C/°C (±0.061 °F/°F)	±0.011 °C/°C (±0.020 °F/°F)
	200 Ω	±1.0 °C (±2.0 °F)	±0.4 °C (±0.7 °F)	±0.034 °C/°C (±0.061 °F/°F)	±0.011 °C/°C (±0.020 °F/°F)
	500 Ω	±0.5 °C (±0.9 °F)	±0.4 °C (±0.7 °F)	±0.014 °C/°C (±0.025 °F/°F)	±0.014 °C/°C (±0.025 °F/°F)
	1000 Ω	±0.5 °C (±0.9 °F)	±0.4 °C (±0.7 °F)	±0.014 °C/°C (±0.025 °F/°F)	±0.014 °C/°C (±0.025 °F/°F)
Copper (426) ⁽³⁾⁽⁴⁾	10 Ω	Not allowed. ⁽⁵⁾	±0.6 °C (±1.1 °F)	Not allowed. ⁽⁵⁾	±0.017 °C/°C (±0.031 °F/°F)
Nickel (618) ⁽³⁾⁽⁶⁾	120 Ω	±0.2 °C (±0.4 °F)	±0.2 °C (±0.4 °F)	±0.008 °C/°C (±0.014 °F/°F)	±0.008 °C/°C (±0.014 °F/°F)
Nickel (672) ⁽³⁾	120 Ω	±0.2 °C (±0.4 °F)	±0.2 °C (±0.4 °F)	±0.008 °C/°C (±0.014 °F/°F)	±0.008 °C/°C (±0.014 °F/°F)
Nickel Iron (518) ⁽³⁾	604 Ω	±0.3 °C (±0.5 °F)	±0.3 °C (±0.5 °F)	±0.010 °C/°C (±0.018 °F/°F)	±0.010 °C/°C (±0.018 °F/°F)

⁽¹⁾ The accuracy values assume that the module was calibrated within the specified temperature range of 0...60 °C (32...140 °F).

⁽²⁾ Temperature drift specifications apply to a module that has not been calibrated.

⁽³⁾ The digits following the RTD unit type represent the temperature coefficient of resistance (α), which is defined as the resistance change per ohm per °C. For instance, Platinum 385 refers to a platinum RTD with $\alpha = 0.00385 \text{ } \Omega/\Omega\text{-}^\circ\text{C}$ or simply $0.00385 \text{ } /^\circ\text{C}$.

⁽⁴⁾ Actual value at 0 °C (32 °F) is 9.042 Ω per SAMA standard RC21-4-1966.

⁽⁵⁾ To maximize the relatively small RTD unit signal, only 2 mA excitation current is allowed.

⁽⁶⁾ Actual value at 0 °C (32 °F) is 100 Ω per DIN standard.

When you are using 100 Ω or 200 Ω platinum RTD units with 0.5 mA excitation current, refer to the following important information about module accuracy.

IMPORTANT

Module accuracy, using 100 Ω or 200 Ω platinum RTD units with 0.5 mA excitation current, depends on the following criteria:

- Module accuracy is ± 0.6 $^{\circ}\text{C}$ (± 33.08 $^{\circ}\text{F}$) after you apply power to the module or perform an autocalibration at 25 $^{\circ}\text{C}$ (77 $^{\circ}\text{F}$) ambient with module operating temperature at 25 $^{\circ}\text{C}$ (77 $^{\circ}\text{F}$).
- Module accuracy is $\pm(0.6$ $^{\circ}\text{C} + \Delta T \times 0.034$ $^{\circ}\text{C}/^{\circ}\text{C})$ or $\pm(33.08$ $^{\circ}\text{F} + \Delta T \times 32.06$ $^{\circ}\text{F}/^{\circ}\text{F})$ after you apply power to the module or perform an autocalibration at 25 $^{\circ}\text{C}$ (77 $^{\circ}\text{F}$) ambient with the module operating temperature between 0... 60 $^{\circ}\text{C}$. (32... 140 $^{\circ}\text{F}$).

Where ΔT is the temperature difference between the actual operating temperature of the module and 25 $^{\circ}\text{C}$ (77 $^{\circ}\text{F}$) and 0.034 $^{\circ}\text{C}/^{\circ}\text{C}$ (32.06 $^{\circ}\text{F}/^{\circ}\text{F}$) is the temperature drift shown in the table above for 100 Ω or 200 Ω platinum RTD units.

Module accuracy is ± 1.0 $^{\circ}\text{C}$ (± 33.80 $^{\circ}\text{F}$) after you apply power to the module or perform an autocalibration at 60 $^{\circ}\text{C}$ (140 $^{\circ}\text{F}$) ambient with module operating temperature at 60 $^{\circ}\text{C}$ (140 $^{\circ}\text{F}$).

Resistance Device Compatibility

The following table lists the resistance input types you can use with the RTD module and gives each type's associated specifications.

Resistance Input Specifications

Input Type	Resistance Range (0.5 mA excitation)	Resistance Range (2.0 mA excitation)	Accuracy ⁽¹⁾	Temperature Drift	Resolution	Repeatability	
Resistance	150 Δ	0...150 Δ	0...150 Δ	(2)	(3)	0.01 Δ	x 0.04 Δ
	500 Δ	0...500 Δ	0...500 Δ	x 0.5 Δ	x 0.014 $\Delta/^\circ\text{C}$ (x 0.025 $\Delta/^\circ\text{F}$)	0.01 Δ	x 0.2 Δ
	1000 Δ	0...1000 Δ	0...1000 Δ	x 1.0 Δ	x 0.029 $\Delta/^\circ\text{C}$ (x 0.052 $\Delta/^\circ\text{F}$)	0.01 Δ	x 0.2 Δ
	3000 Δ	0...3000 Δ	0...1900 Δ	x 1.5 Δ	x 0.043 $\Delta/^\circ\text{C}$ (x 0.077 $\Delta/^\circ\text{F}$)	0.01 Δ	x 0.2 Δ

⁽¹⁾ The accuracy values assume that the module was calibrated within the specified temperature range of 0...60 $^\circ\text{C}$ (32...140 $^\circ\text{F}$).

⁽²⁾ The accuracy for 150 Ω is dependant on the excitation current:

- x 0.2 Ω at 0.5 mA
- x 0.15 Ω at 2.0 mA

⁽³⁾ The temperature drift for 150 Ω is dependant on the excitation current:

- x 0.006 $\Omega/^\circ\text{C}$ at 0.5 mA
- x 0.004 Ω at 2.0 mA

Hardware Overview

The RTD module fits into a single-slot of an SLC 500 chassis.

- Modular system, except the processor slot (0)
- Fixed system expansion chassis (1746-A2)

The module uses eight input words and eight output words.

IMPORTANT

If the RTD module resides in a remote configuration with a SLC 500 Remote I/O Adapter Module (1747-ASB), use block transfer for configuration and data retrieval. Block transfer requires a 1747-SN Remote I/O Scanner (series B) or PLC processor.

The module contains a removable terminal block (item 3) providing connection for any mix of four RTD sensors or resistance input devices. There are no output channels on the module. Module configuration is done via the user program. There are no DIP switches.

RTD Module Hardware

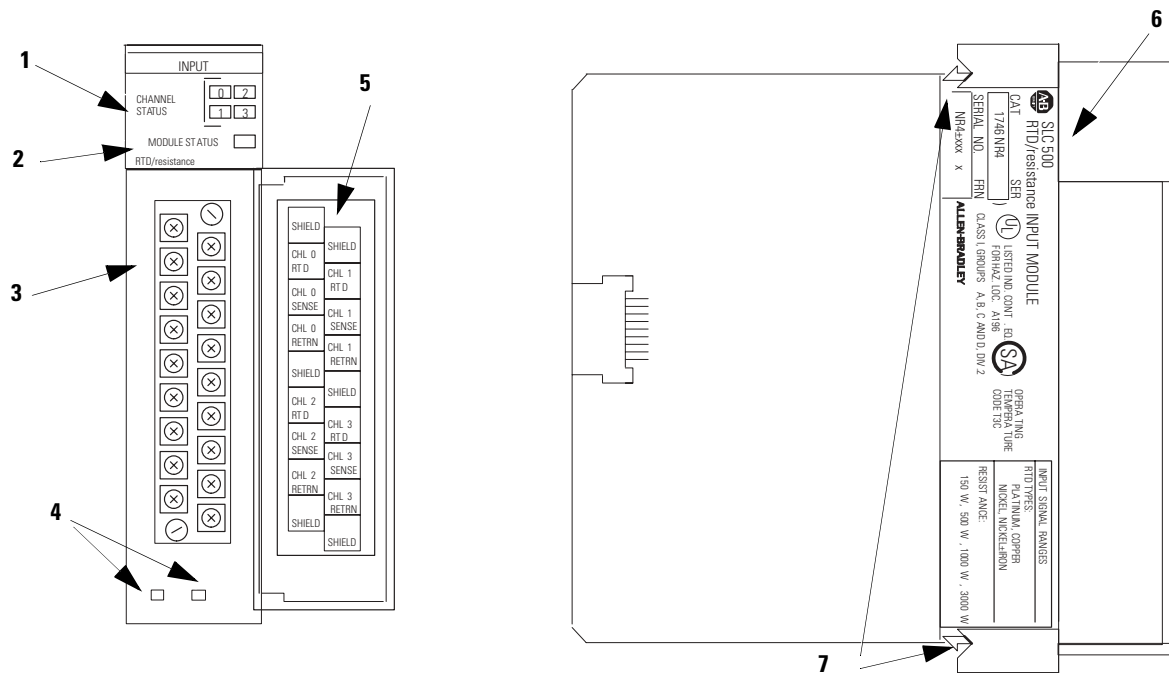

Hardware Features

Feature	Description	
1	Channel Status LED Indicators (green)	Display operating and fault status of channels 0, 1, 2, and 3
2	Module Status LED (green)	Displays module operating and fault status
3	Removable Terminal Block	Provides physical connection to input devices
4	Cable Tie Slots	Secure wiring from module
5	Door Label	Provides terminal identification
6	Side Label (Nameplate)	Provides module information
7	Self-locking Tabs	Secure module in chassis slot

General Diagnostic Features

The RTD module contains diagnostic features that can be used to help you identify the source of problems that may occur while you turn on the power or during normal channel operation.

The power and channel diagnostics are explained in Chapter 7, Module Diagnostics and Troubleshooting.

System Overview

The RTD module communicates to the SLC 500 processor through the parallel backplane interface and receives +5V dc and +24V dc power from the SLC 500 power supply through the backplane. No external power supply is required. You may install as many RTD modules in your system as the power supply can support.

RTD Module Configuration

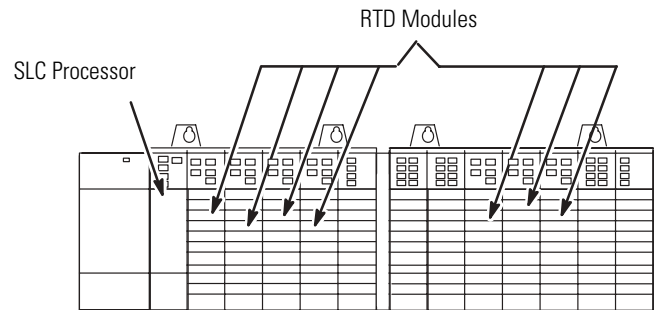

Each individual channel on the RTD module can receive input signals from two, three or four wire RTD sensors or from resistance input devices. You configure each channel to accept either input. When configured for RTD input types, the module converts the RTD readings into linearized, digital temperature readings in °C or °F. When configured for resistance inputs, the module provides a linear resistance value in ohms.

IMPORTANT

The RTD module is designed to accept input from RTD sensors with up to three wires. When using 4-wire RTD sensors, one of the two lead compensation wires is not used and the 4-wire sensor is treated like a 3-wire sensor. Lead wire compensation is provided via the third wire.

See NR4 Wiring Considerations on page 40 for more information.

System Operation

The RTD module has three operational states.

- Cycle power
- Module operation
- Error (module error and channel error)

Cycle Power

When you cycle the module's power, the RTD module checks its internal circuits, memory, and basic functions via hardware and software diagnostics. During this time the module status LED indicator remains off. If no faults are found during the diagnostics, the module status LED indicator is on.

After the checks are complete, the RTD module waits for valid channel configuration data from your SLC ladder logic program (channel status LED indicators off). After configuration data is written to one or more channel configuration words and their channel enable bits are set by the user program, the channel status LED indicators go on and the module continuously converts the RTD or resistance input to a value within the range you selected for the enabled channels. The module is now operating in its normal state.

Each time a channel is read by the module, that data value is tested by the module for a fault condition, for example, open circuit, short circuit, over range, and under range. If such a condition is detected, a unique bit is set in the channel status word and the channel status LED indicator blinks, indicating a channel error condition.

The SLC processor reads the converted RTD or resistance data from the module at the end of the program scan or when commanded by the ladder program. The processor and RTD module determine that the backplane data transfer was made without error and the data is used in your ladder program.

Module Operation

Each input channel consists of an RTD connection, which provides:

- excitation current.
- a sense connection, which detects lead-wire resistance.
- a return connection, which reads the RTD or resistance value.

Each of these analog inputs are multiplexed to one of two analog convertors.

The A/D converters cycle between reading the RTD or resistance value, the lead wire resistance, and the excitation current. From these readings, an accurate temperature or resistance is returned to the user program.

The RTD module is isolated from the chassis backplane and chassis ground. The isolation is limited to 500V dc. Optocouplers are used to communicate across the isolation barrier. Channel-to-channel common-mode isolation is limited to X 1 volt.

LED Indicator Status

The following figure shows the RTD module LED indicator panel consisting of five LED indicators. The state of the LED indicators (for example, off, on, or blinking) depends on the operational state of the module.

See the LED Indicator Status table on page 21.

LED Indicators

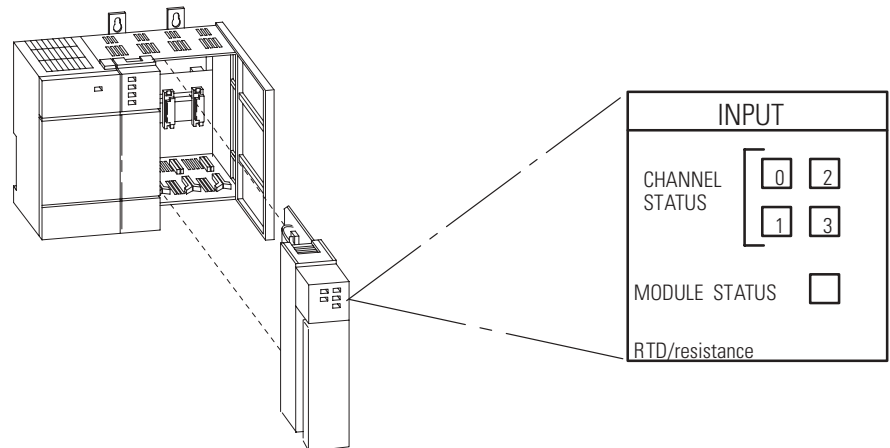

The purpose of the LED indicators is to provide:

- Channel Status - One LED indicator for each of the four input channels indicates if the channel is enabled, disabled, or is not operating as configured, due to an error.
- Module Status - If OFF at any time, other than when you cycle module power, this LED indicator indicates that non-recoverable module errors (for example, diagnostic or operating errors) have occurred. The LED indicator is ON if there are no module errors.

The status of each LED indicator, during each of the operational states (for example, powerup, module operation and error), is depicted in the following table.

LED Indicator Status

LED Indicator	Cycle Power	Module Operation (No Error)	Module Error	Channel Error
Ch 0 Status	Off ⁽¹⁾	On/Off ⁽²⁾	Off	Blinks
Ch 1 Status	Off ⁽¹⁾	On/Off ⁽²⁾	Off	Blinks
Ch 2 Status	Off ⁽¹⁾	On/Off ⁽²⁾	Off	Blinks
Ch 3 Status	Off ⁽¹⁾	On/Off ⁽²⁾	Off	Blinks
Mod. Status	Off ⁽¹⁾	On	Off	On

⁽¹⁾ Module is disabled while you cycle module power.

⁽²⁾ Channel status LED indicator is ON if the respective channel is enabled and OFF if the channel is disabled.

Module to Processor Communication

The RTD module communicates with the SLC processor through the backplane of the chassis. The RTD module transfers data to and receives data from the processor by means of an image table. The image table consists of eight input words and eight output words. Data transmitted from the module to the processor is called the input image (for example, Channel Data Words and Channel Status Words). Conversely, data transmitted from the processor to the module is called the output image (for example, Channel Configuration Words and Scaling Limit Words).

Details about the input and output images are found in Module Addressing on page 52 and 53.

Communication Flow

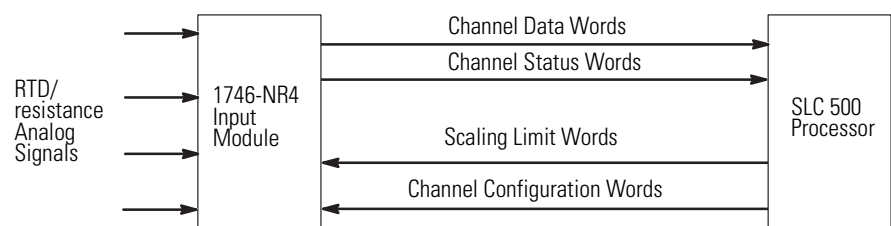

Image Table

Input Image Word	Function	Output Image Word	Function
0	Channel 0 data	0	Channel 0 configuration
1	Channel 1 data	1	Channel 1 configuration
2	Channel 2 data	2	Channel 2 configuration
3	Channel 3 data	3	Channel 3 configuration
4	Channel 4 data	4	User-set Lower limit scale 0
5	Channel 5 data	5	User-set Upper limit scale 0
6	Channel 6 data	6	User-set Lower limit scale 1
7	Channel 7 data	7	User-set Upper limit scale 1

The Channel Configuration Words (output image) contain user-defined configuration information for the specified input channel. This information is used by the module to configure and operate each channel. The Channel Status Words (input image) contain status information about the channel's current configuration and operational state. The input data values of the analog input channel are contained in the Channel Data Word (input image), which is valid only when the channel is enabled and there are no channel errors (for example, broken sensor or overrange.)

You set the Scaling Limit Words (output image) to provide a definable scaling range for the temperature resistance data when using the proportional counts data type.

Quick Start Guide

This chapter helps you get started using the RTD module. The procedures included here assume that you have a basic understanding of SLC 500 products.

You must:

- understand electronic process control.
- be able to interpret the ladder logic instructions for generating the electronic signals that control your application.

Because this is a start-up guide, this chapter does not contain detailed explanations about the procedures listed. It does, however, reference other chapters in this book where you can get more detailed information.

If you have any questions or are unfamiliar with the terms used or concepts presented in the procedural steps, always read the referenced chapters and other recommended documentation before trying to apply the information.

This chapter:

- tells you what equipment you need.
- explains how to install and wire the module.
- shows you how to set up one channel for RTD or resistance input.
- examines the state of the LED indicators at normal startup.
- examines the channel status word.

Required Tools and Equipment

Have the following tools and equipment ready.

- Medium blade screwdriver
- Medium cross-head screwdriver
- RTD module (1746-NR4)
- RTD sensor or resistance input
- Appropriate cable (if needed)
- Programming software

Procedures

Follow these procedures to get your RTD module installed and ready to use.

Unpack the Module

Unpack the module making sure that the contents include:

- RTD module, catalog number 1746-NR4.
- Installation instructions, publication 1746-IN012.

If the contents are incomplete contact your Allen-Bradley representative for assistance.

Determine Power Requirements

Review the requirements of your system to see that your chassis supports placement of the RTD module.

- The fixed, 2-slot chassis supports two RTD modules.

If combining an RTD module with a different module, refer to the module compatibility table found in chapter 3.

- For modular style systems, calculate the total load on the system power supply using the procedure described in the SLC 500 Modular Style User Manual, publication 1747-UM011.

For more information refer to chapter 3, Install and Wire and Appendix A, Specifications.

Insert the Module

ATTENTION

Never install, remove, or wire modules with power applied to the chassis or devices wired to the module.

For more information refer to chapter 3, Install and Wire.

Make sure system power is off; then insert the RTD module into your 1746 chassis. In this example procedure, local slot 1 is selected.

Module Insertion into Chassis

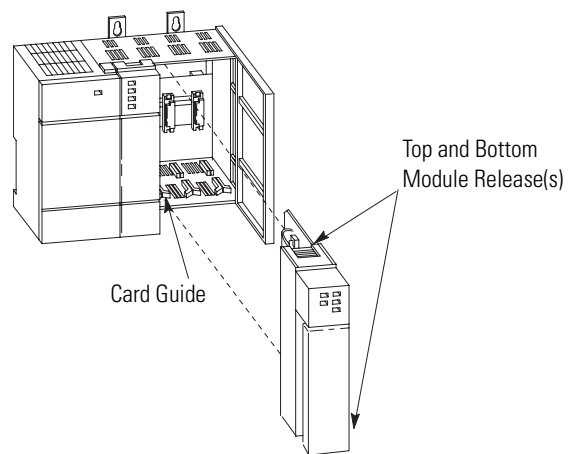

Wire the Module

Connect RTD module or potentiometer wire leads to channel 0 of the RTD module.

See RTD Connections to Terminal Block on page 26, Two-wire Potentiometer Connections to Terminal Block on page 27, or Three-wire Potentiometer Connections to Terminal Block on page 28.

For more information refer to chapter 3, Install and Wire.

RTD Connections to Terminal Block

For details on wiring an RTD unit to the module, see chapter 3.

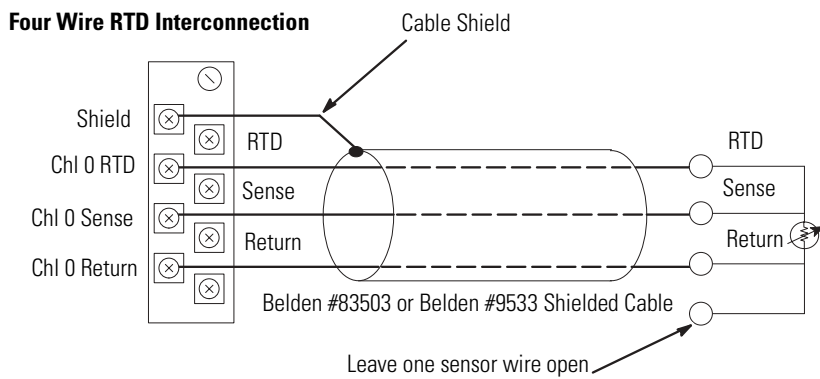
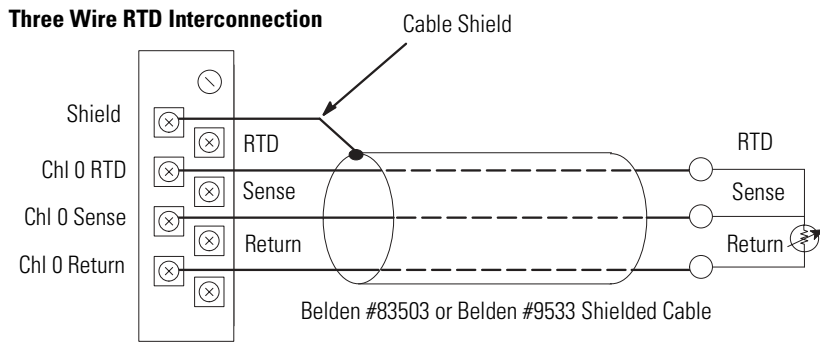
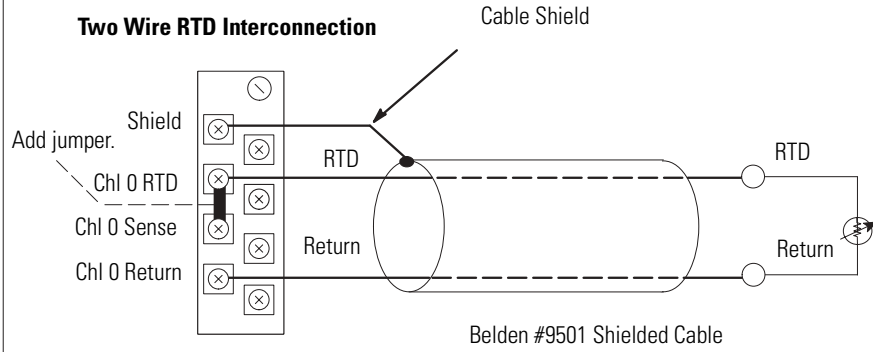

Terminal Pin-outs

Shield	Shield
Chl 0 RTD	Chl 1 RTD
Chl 0 Sense	Chl 1 Sense
Chl 0 Return	Chl 1 Return
Shield	Shield
Chl 2 RTD	Chl 3 RTD
Chl 2 Sense	Chl 3 Sense
Chl 2 Return	Chl 3 Return
Shield	Shield

Two-wire Potentiometer Connections to Terminal Block

For details on wiring an RTD unit to the module, see chapter 3.

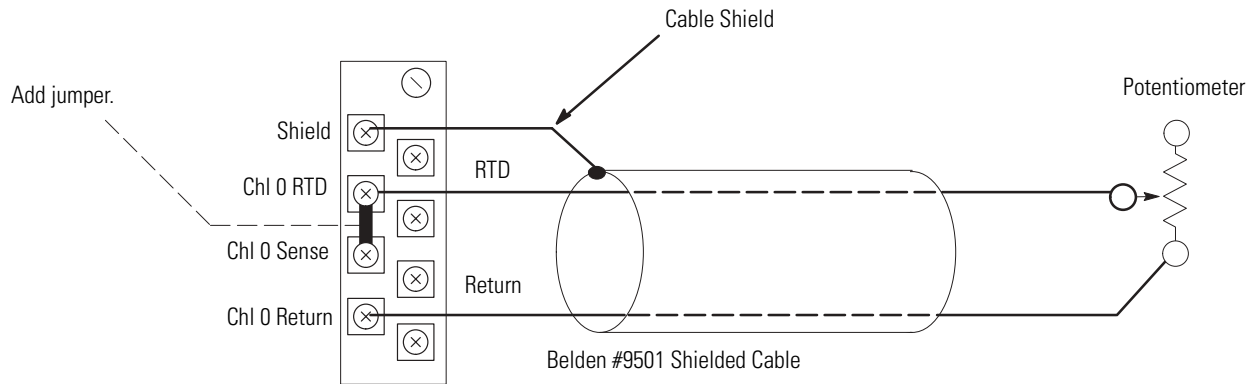

Potentiometer wiper arm can be connected to either the RTD or return terminal depending on whether the user wants increasing or decreasing resistance.

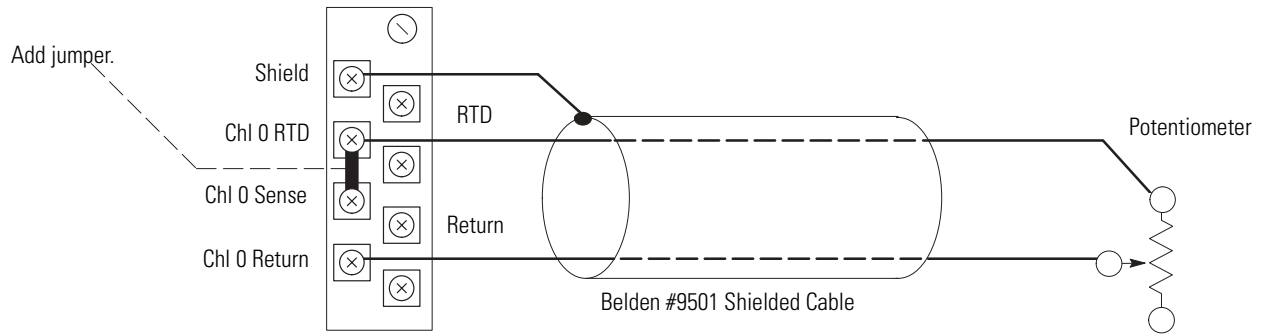

Three-wire Potentiometer Connections to Terminal Block

For details on wiring an RTD to the module, see chapter 3.

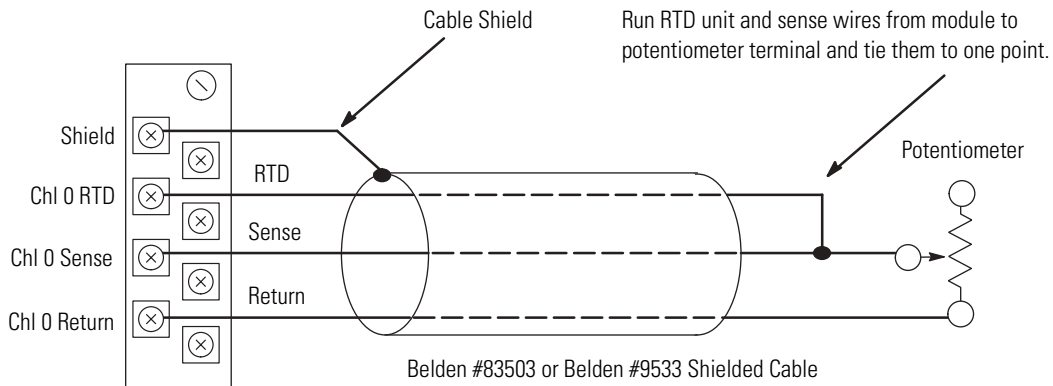

Potentiometer wiper arm can be connected to either the RTD or return terminal depending on whether you want increasing or decreasing resistance.

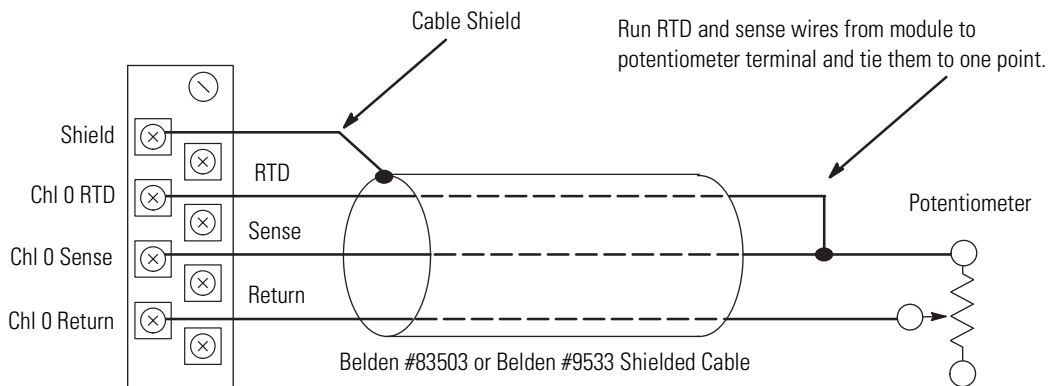

Configure Your I/O

Configure your system I/O configuration for the particular slot where the RTD module resides (slot 1 in this example). Select the 1746-NR4 module from the list of modules, or if it is not listed in your software version, select Other and enter the RTD module ID code (3513) at the prompt on the I/O configuration display.

For more information refer to chapter 4, Preliminary Operating Considerations.

Configure the Module

Determine the operating parameters for channel 0. In this example, the figure shows the channel 0 configuration word defined with all defaults (0) except for channel enable (bit 11). The addressing reflects the location of the module as slot 1.

For details on how to configure the module for your application, refer to chapter 4 and chapter 5.

A configuration worksheet is included on page 132 to assist you in channel configuration.

For more information refer to chapter 5, Channel Configuration, Data, and Status.

Output Image Detail

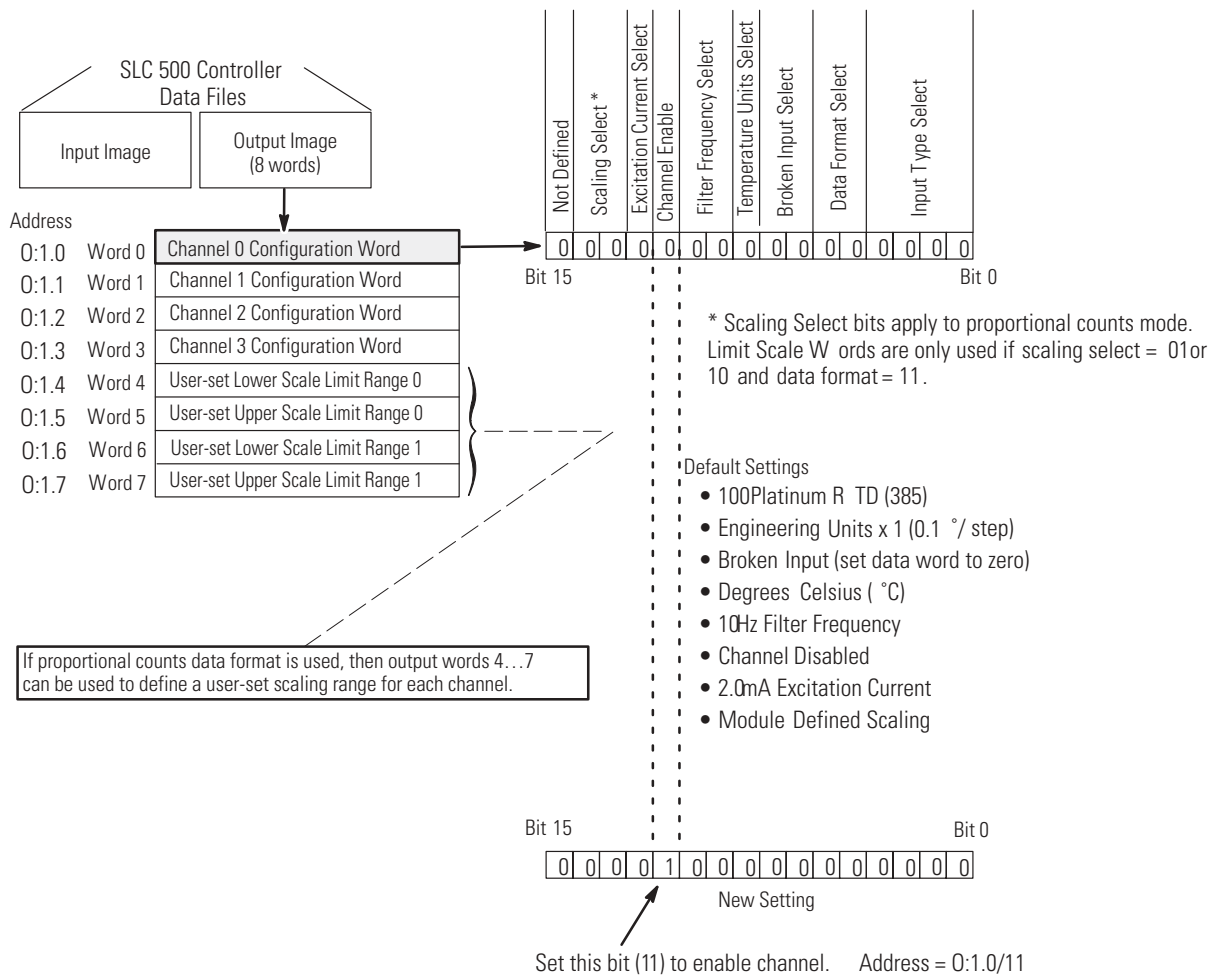

Program the Configuration

Follow these steps to complete the programming necessary to establish the new configuration word setting in the previous step.

1. Create integer file N10 using the memory map function.

Integer file N10 should contain one element for each channel used. For this example we only need one, N10:0.

2. Enter the configuration parameters for channel 0 into integer N10:0.

In this example, all the bits of N10:0 are zero except for the channel enable (N10:0/11).

3. Program an instruction in your ladder logic to copy the contents of N10:0 to output word O:1.0.

See Output Image Detail on page 28.

For more information refer to chapter 6, Ladder Programming Examples and chapter 8, Application Examples.

Initial Configuration Word Setting

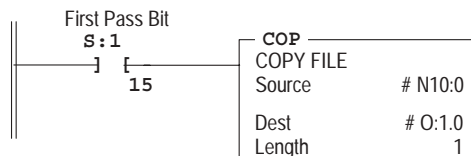
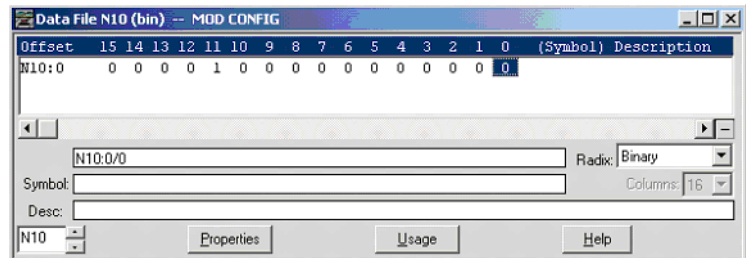

On power-up, the first pass bit (S:1/15) is set for one scan, enabling the COPY instruction that transfers a one to bit 11 of channel configuration word 0. This enables channel 0, which directs the RTD module to scan channel 0 and to present the analog data to the SLC processor.

Write Remaining Ladder Logic

The Channel Data Word contains the information that represents the temperature value or resistance value of the input channel. Write the remainder of the ladder logic program that specifies how your RTD/resistance input data is processed for your application. In this procedure, the addressing reflects the location of the module as slot 1.

Input Image Detail

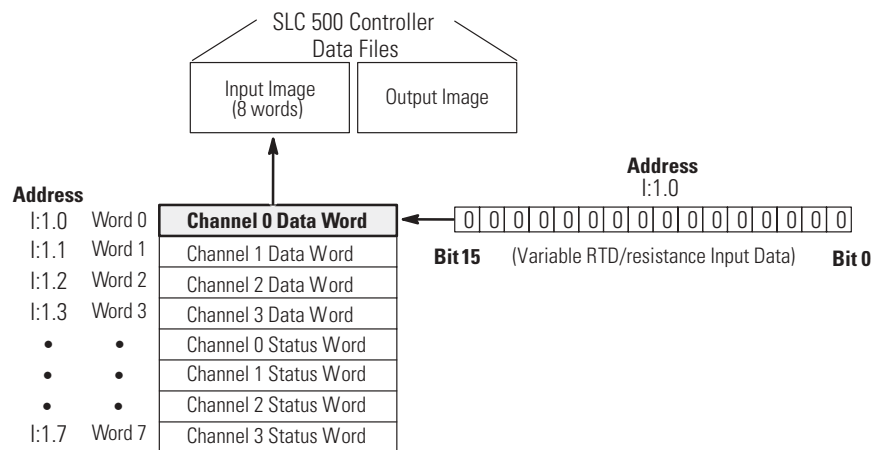

Test Your RTD Program

1. Apply power.

The module status LED indicator and channel 0 status LED indicator turn on.

2. Download your program to the SLC processor.
3. Make sure the controller is in Run mode.

For more information see chapter 7, Module Diagnostics and Troubleshooting.

LED Indicator Status

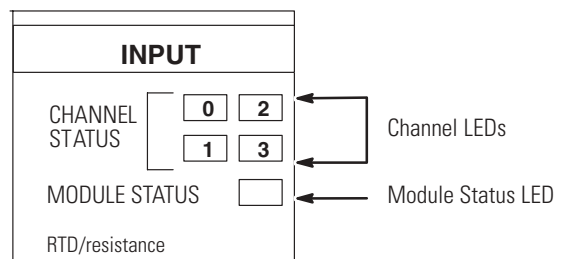

Program Functional Check (Optional)

Monitor the status of input channel 0 to determine its configuration setting and operational status. This is useful for troubleshooting when the blinking channel LED indicator indicates that an error has occurred.

If the Module Status LED indicator is off, or if the Channel 0 LED indicator is off or blinking, refer to chapter 7.

For more information see chapter 5, chapter 7, and chapter 8.

Monitoring Status

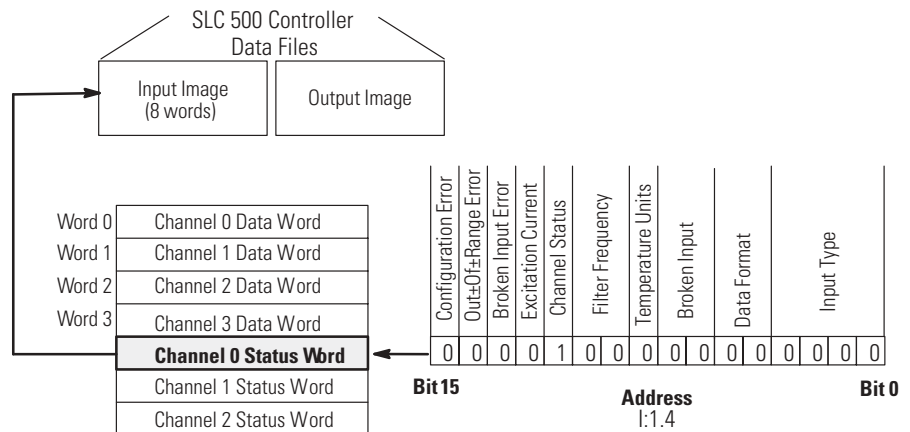

For this example, only bit 11 is set during normal operation.

Install and Wire the Module

This chapter tells you how to:

- avoid electrostatic damage.
- determine the RTD module's chassis power requirement.
- choose a location for the RTD module in the SLC chassis.
- install the RTD module.
- wire the RTD module's terminal block.

If this product has the CE mark it is approved for installation within the European Union and EEA regions. It has been designed and tested to meet the following directives.

EMC Directive

This product is tested to meet Council Directive 89/336/EEC Electromagnetic Compatibility (EMC) and the following standards, in whole or in part, documented in a technical construction file:

- EN 50081–2
EMC - Generic Emission Standard, Part 2 - Industrial Environment
- EN 50082–2
EMC - Generic Immunity Standard, Part 2 - Industrial Environment

This product is intended for use in an industrial environment.

Electrostatic Damage

Electrostatic discharge can damage semiconductor devices inside this module if you touch backplane connector pins or other sensitive areas. Guard against electrostatic damage by observing the precautions listed next.

ATTENTION

Electrostatic discharge can degrade performance or cause permanent damage. Handle the module as stated below.

Wear an approved wrist strap grounding device when handling the module.

- Touch a grounded object to rid yourself of electrostatic charge before handling the module.
- Handle the module from the front, away from the backplane connector. Do not touch backplane connector pins.
- Keep the module in its static-shield bag when not in use, or during shipment.

NR4 Power Requirements

The RTD module receives its power through the SLC 500 chassis backplane from the fixed or modular +5V dc/+24V dc chassis power supply. The maximum current drawn by the module is shown in the table below.

5V dc Amps	24V dc Amps
0.050	0.050

When you are using a modular system configuration, add the values shown in the table above to the requirements of all other modules in the SLC chassis to prevent overloading the chassis power supply.

When you are using a fixed system controller, refer to the Important note about module compatibility in a two-slot expansion chassis on page 35.

Module Location in Chassis This section contains information on module location in modular and fixed chassis.

Modular Chassis Considerations

Place your RTD module in any slot of an SLC 500 modular chassis (except slot 0) or a modular expansion chassis. Slot 0 is reserved for the modular processor or adapter modules.

Fixed Expansion Chassis Considerations

IMPORTANT

The 2-slot, SLC 500 fixed I/O expansion chassis (1746-A2) supports only specific combinations of modules. If you are using the RTD module in a 2-slot expansion chassis with another SLC I/O or communication module, refer to the Fixed Controller Compatibility Table to determine whether the combination can be supported.

When using the Fixed Controller Compatibility Table, be aware that there are certain conditions that affect the compatibility characteristics of the BASIC module (BAS) and the DH-485/RS-232C module (KE).

When you use the BAS module or the KE module to supply power to a 1747-AIC Link Coupler, the link coupler draws its power through the module. The higher current drawn by the AIC at 24V dc is calculated and recorded in the table for the modules identified as BASn (BAS networked) or KEn (KE networked). Make sure to refer to these modules if your application uses the BAS or KE module in this way.

Fixed Controller Compatibility Table

Modules	NR4	5V dc (Amps)	24V dc (Amps)
IA4	• (1)	0.035	-
IA8	•	0.050	-
IA16	•	0.085	-
IM4	•	0.035	-
IM8	•	0.050	-
IM16	•	0.085	-
OA8	•	0.185	-
OA16	•	0.370	-
OAP12	•	0.370	-
IB8	•	0.050	-
IB16	•	0.085	-
IV8	•	0.050	-
IV16	•	0.085	-
IG16	•	0.140	-
IH16	•	0.085	-
OV8	•	0.135	-
OV16	•	0.270	-
OB8	•	0.135	-
OBP8	•	0.135	-
OG16	•	0.180	-
OW4	•	0.045	0.045
OW8	•	0.085	0.090
OW16	(2)	0.170	0.180
IO4	•	0.030	0.025
IO8	•	0.060	0.045
IO12	•	0.090	0.070
NI4	•	0.025	0.085
NI8	•	0.200	0.100
NIO4I	•	0.055	0.145
NIO4V	•	0.055	0.115
FIO4I	•	0.055	0.150
FIO4V	•	0.055	0.120
DCM	•	0.360	-
HS	•	0.300	-
OB16	•	0.280	-
OB16E	•	0.135	-
IN16	•	0.085	-
BASn	•	0.150	0.125
BAS	•	0.150	0.040
OB32		0.452	-
OV32		0.452	-
IV32	•	0.106	-
IB32	•	0.106	-

Fixed Controller Compatibility Table

Modules	NR4	5V dc (Amps)	24V dc (Amps)
OX8	•	0.085	0.090
NO4I	$\Delta^{(3)}$	0.055	0.195
NO4V	•	0.055	0.145
ITB16	•	0.085	-
ITV16	•	0.085	-
IC16	•	0.085	-
KE	•	0.150	0.40
KE _n	•	0.150	0.145
OBP16	•	0.250	-
OVP16	•	0.250	-
NT4	•	0.060	0.040
NR4	•	0.050	0.050
HSTP1	•	0.200	-

⁽¹⁾ A dot indicates a valid combination.

⁽²⁾ No symbol indicates an invalid combination.

⁽³⁾ A triangle indicates an external power supply is required.

General Considerations

Most applications require installation in an industrial enclosure to reduce the effects of electrical interference. RTD inputs are susceptible to electrical noises due to the small amplitudes of their signal.

Group your modules to minimize adverse effects from radiated electrical noise and heat. Consider the following conditions when selecting a slot for the RTD module. Position the module in a slot:

- away from power lines, load lines and other sources of electrical noise such as hard-contact switches, relays, and AC motor drives.
- away from modules which generate significant radiated heat, such as the 32-point I/O modules.

Module Installation and Removal

When installing the module in a chassis, it is not necessary to remove the terminal block from the module. However, if the terminal block is removed, use the write-on label located on the side of the terminal block to identify the module location and type.

Write-on Label

SLOT ____	RACK ____
• MODULE _____	

Remove the Terminal Block

ATTENTION



Never install, remove or wire modules with power applied to the chassis or devices wired to the module. To avoid cracking the removable terminal block alternate the removal of the slotted terminal block release screws.

1. Loosen the two terminal block release screws.

Terminal Block Release Screws
Max. Torque = 0.6 Nm (5.3 in-lbs)

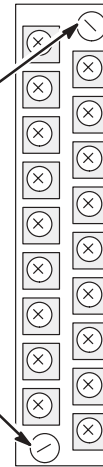

2. Grasp the terminal block at the top and bottom and pull outward and down.

Install the Module

1. Align the circuit board of the RTD module with the card guides located at the top and bottom of the chassis.

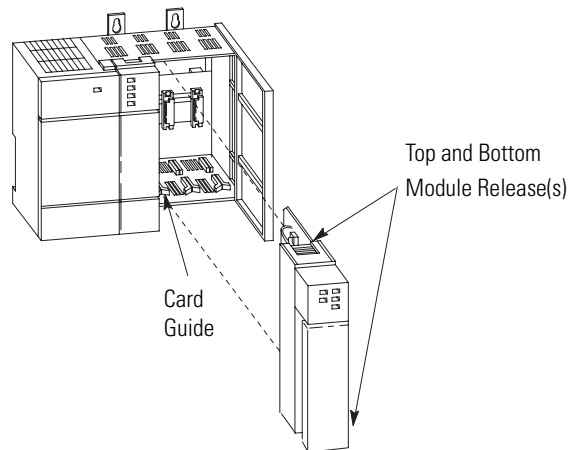

2. Slide the module into the chassis until both top and bottom retaining clips are secured. Apply firm even pressure on the module to attach it to its backplane connector. Never force the module into the slot.
3. Cover all unused slots with the Card Slot Filler, catalog number 1746-N2.

Remove the Module

1. Press the releases at the top and bottom of the module and slide the module out of the chassis slot.
2. Cover all unused slots with the Card Slot Filler, Catalog Number 1746-N2.

Terminal Wiring

The RTD module contains an 18-position, removable terminal block. The terminal pin-out is shown in RTD Connections to Terminal Block on page 42.

ATTENTION

Disconnect power to the SLC before attempting to install, remove, or wire the removable terminal wiring block.



To avoid cracking the removable terminal block, alternate the removal of the terminal block release screws.

Terminal Block

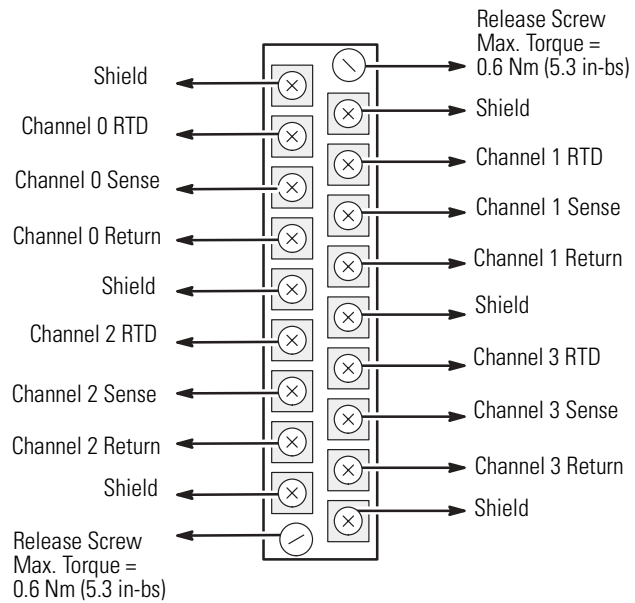

NR4 Wiring Considerations

Follow the guidelines below when planning your system wiring.

Since the operating principle of the RTD module is based on the measurement of resistance, take special care in selecting your input cable. For 2-wire or 3-wire configuration, select a cable that has a consistent impedance throughout its entire length.

Cable Selection

Configuration	Recommended Cable
Two-wire	Belden #9501 or equivalent
Three-wire less than 30.48 m (100 ft)	Belden #9533 or equivalent
Three-wire greater than 30.48 m (100 ft) or high humidity conditions	Belden #83503 or equivalent

For a three-wire configuration, the module can compensate for a maximum cable length associated with an overall cable impedance of 25 ohms.

IMPORTANT

Details of cable specifications are shown on page 122.

As shown in RTD Connections to Terminal Block on page 42, three configurations of RTDs can be connected to the RTD module, namely:

- two-wire RTD, which is composed of two RTD lead wires (RTD and Return).
- three-wire RTD, which is composed of a Sense and two RTD lead wires (RTD and Return).
- four-wire RTD, which is composed of two Sense and two RTD lead wires (RTD and Return). The second sense wire of a four-wire RTD is left open. It does not matter which sense wire is left open.

IMPORTANT

The RTD module requires three wires to compensate for lead resistance error. It is recommended that you do not use two-wire RTDs if long cable runs are required, as it will reduce the accuracy of the system. However, if a two-wire configuration is required, reduce the effect of the lead wire resistance by using a lower gauge wire for the cable (for example, use 1.291 mm (16 AWG) instead of 0.511 mm (24 AWG)). Also, use cable that has a lower resistance per foot of wire. The module's terminal block accepts two 2.5 mm² (14 AWG) gauge wires.

- To limit overall cable impedance, keep input cables as short as possible. Locate your I/O chassis as near the RTD sensors as your application will permit.
- Ground the shield drain wire at one end only. The preferred location is at the RTD module. Refer to IEEE Std. 518, Section 6.4.2.7 or contact your sensor manufacturer for additional details.
- Each input channel has a shield connection screw terminal that provides a connection to chassis ground. All shields are internally connected, so any shield terminal can be used with channels 0...3.
- Route RTD/resistance input wiring away from any high-voltage I/O wiring, power lines, and load lines.

- Tighten terminal screws using a flat or cross-head screwdriver. Each screw should be turned tight enough to immobilize the wire's end. Excessive tightening can strip the terminal screw. The torque applied to each screw should not exceed 0.565 Nm (5 in-lb) for each terminal.
- Follow system grounding and wiring guidelines found in your SLC 500 Installation and Operation Manual, publication 1747-UM011.

RTD Connections to Terminal Block

Two-wire RTD Interconnection

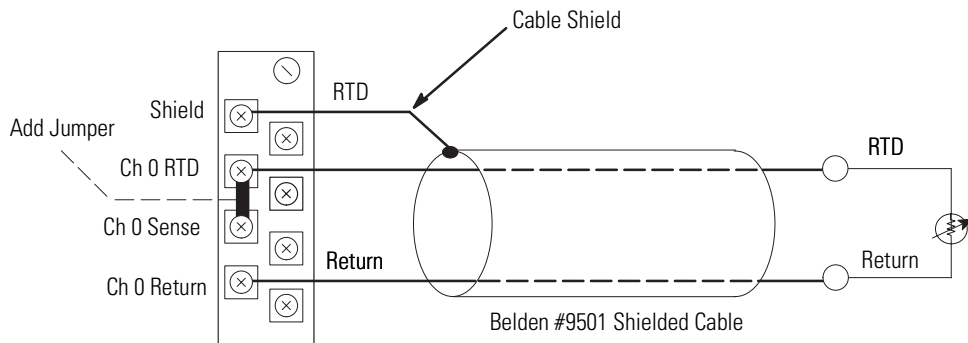

Three-wire RTD Interconnection

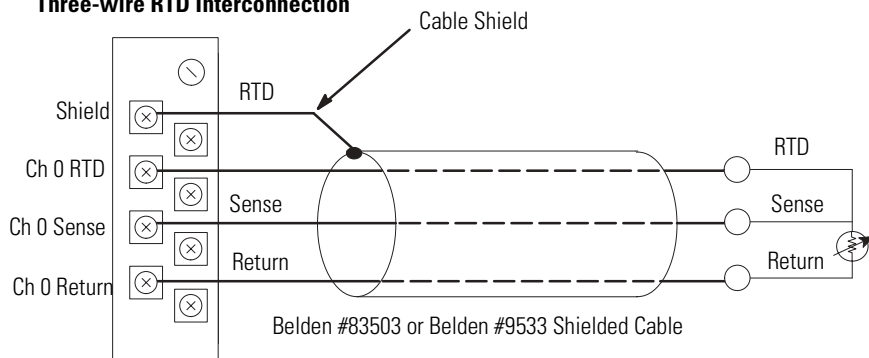

Four-wire RTD Interconnection

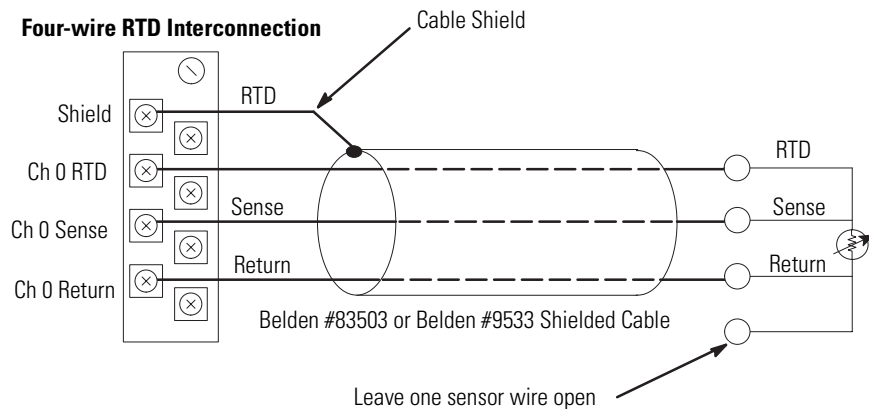

Terminal Pin-outs

Shield	Shield
Chl 0 RTD	Chl 1 RTD
Chl 0 Sense	Chl 1 Sense
Chl 0 Return	Chl 1 Return
Shield	Shield
Chl 2 RTD	Chl 3 RTD
Chl 2 Sense	Chl 3 Sense
Chl 2 Return	Chl 3 Return
Shield	Shield

When using a three-wire configuration, the module compensates for resistance error due to lead wire length. For example, in a three-wire configuration, the module reads the resistance due to the length of one of the wires and assumes that the resistance of the other wire is equal. If the resistances of the individual lead wires are much different, an error may exist. The closer the resistance values are to each other, the greater the amount of error that is eliminated.

IMPORTANT

To ensure temperature or resistance value accuracy, the resistance difference of the cable lead wires must be equal to or less than 0.01Ω

There are several ways to insure that the lead values match as closely as possible.

- Keep lead resistance as small as possible and less than 25Ω
- Use quality cable that has a small tolerance impedance rating.
- Use a heavy-gauge lead wire which has less resistance per foot.

Wire the Resistance Devices (Potentiometers) to the NR4 Module

Potentiometer wiring requires the same type of cable as that for the RTD described in the previous subsection. Potentiometers can be connected to the RTD module as a two-wire interconnection or a three-wire interconnection.

See Two-wire Potentiometer Connections to Terminal Block, on page 44, for 2-wire connection and Three-wire Potentiometer Connections To Terminal Block, on page 45, for 3-wire connection.

Two-wire Potentiometer Connections to Terminal Block

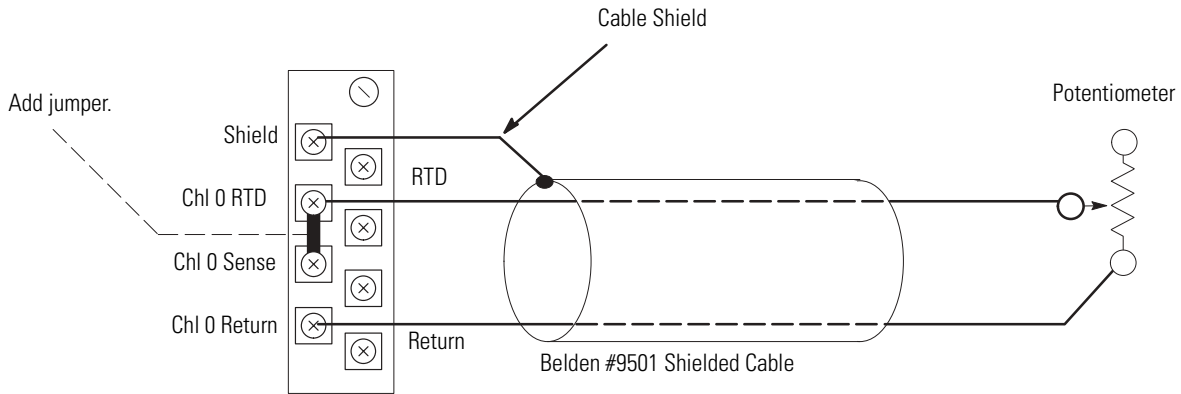

Potentiometer wiper arm can be connected to either the RTD or return terminal depending on whether the user wants increasing or decreasing resistance.

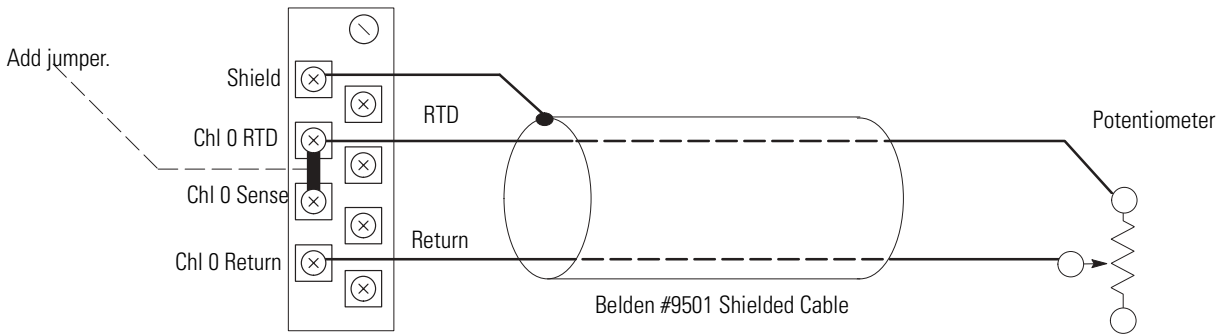

Three-wire Potentiometer Connections To Terminal Block

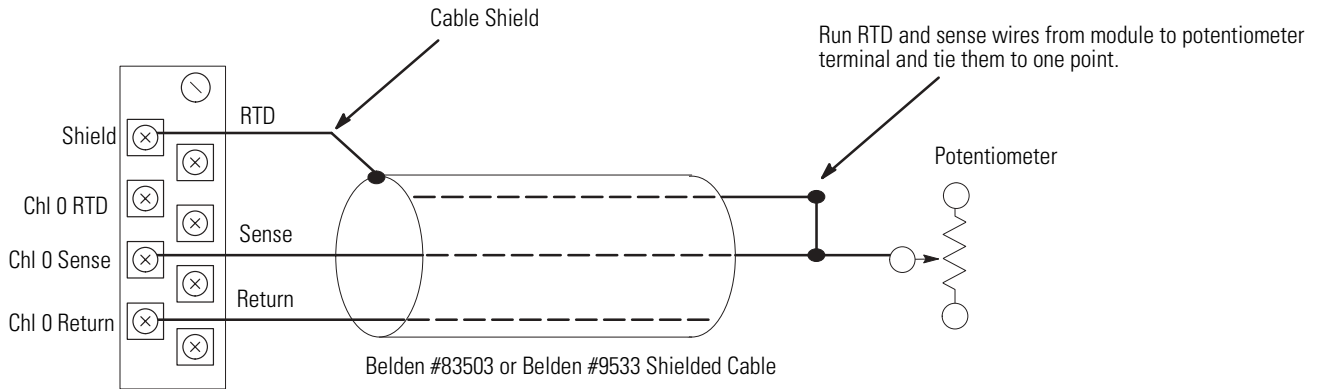

Potentiometer wiper arm can be connected to either the RTD or return terminal depending on whether the user wants increasing or decreasing resistance.

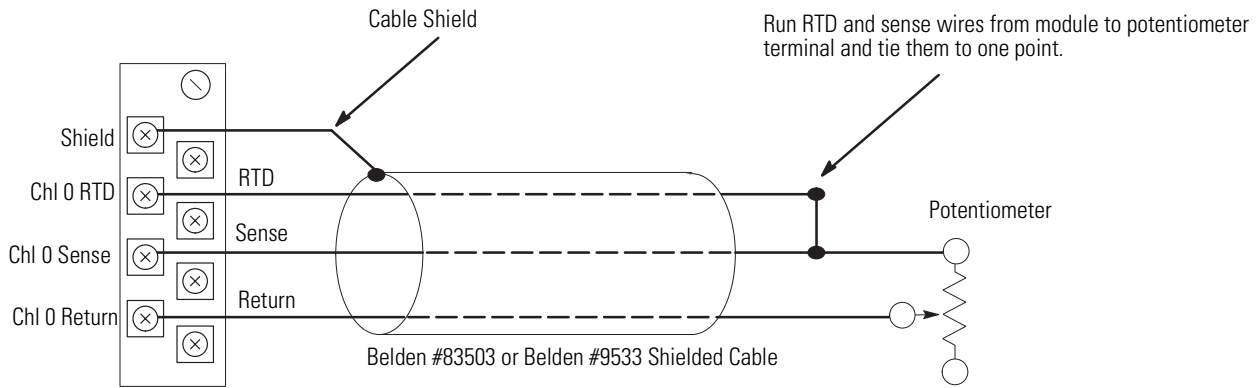

Follow these steps to wire your 1746-NR4 module.

1. At each end of the cable, strip some casing to expose the individual wires.
2. Trim the signal wires to 5.08 cm (2 in.) lengths. Strip about 4.76 mm (3/16 in.) of insulation away to expose the end of the wire.
3. At one end of the cable twist the drain wire and foil shield together, bend them away from the cable, and apply shrink wrap. Then earth ground at the shield terminal.
4. At the other end of the cable, cut the drain wire and foil shield back to the cable and apply shrink wrap.
5. Connect the signal wires and cable shield to the NR4 terminal block and the input.
6. Repeat steps 1 through 5 for each channel on the NR4 module.

Cable Examples

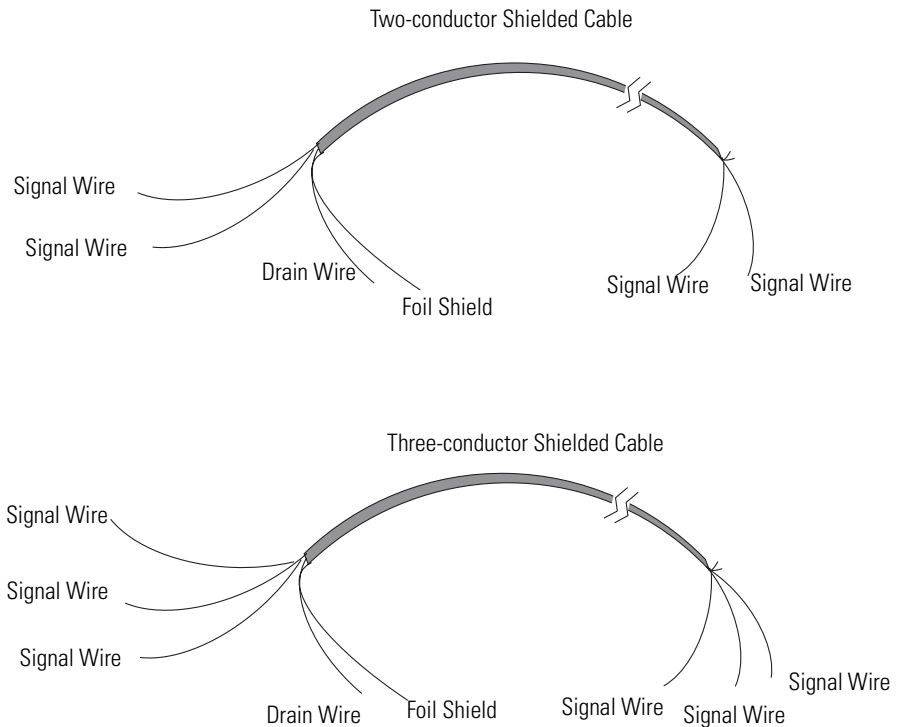

Calibration

The accuracy of a system that uses the RTD module is determined by:

- the accuracy of the RTD.
- resistance mismatch of the cable wires that connect the RTD to the module.
- the accuracy of the RTD module.

For optimal performance at the customer site, the RTD module is calibrated at the factory prior to shipment. In addition, a self-calibration feature, called autocalibration, further ensures that the module performs to specification over the life of the product.

Factory Calibration

The four-pin calibration connector, on the RTD module circuit board, is used for factory setup only.

Auto-calibration

When a channel becomes enabled, the module configures the channel and performs an auto-calibration on the channel. The channel is selected, the excitation current is turned off, and the three input lines for the channel are connected to analog common. The module's A/D converters are configured for the proper gain and filter frequency that is appropriate for your RTD configuration. Auto-calibration performs an A/D conversion on the zero voltage (analog common) and the full-scale voltage (A/D reference voltage) on the following signals:

- Lead wire signal
- RTD/resistance signal
- Excitation current signal

IMPORTANT

Channel calibration time is shown in the Channel Calibration Time table.

These conversions generate offset (zero reference) and full scale (span reference) coefficients that are saved and used by the module to perform future A/D conversions on this channel.

You can command your module to perform an auto-calibration cycle by disabling a channel, waiting for the channel status bit to change state (1 to 0) and then re-enabling that channel. Several scan cycles are required to perform an auto-calibration (refer to page 4-11). It is important to remember that during auto-calibration the module is not converting input data.

TIP

To maintain system accuracy it is recommended that you periodically perform an autocalibration cycle:

- whenever an event occurs that greatly changes the internal temperature of the control cabinet, such as opening or closing its door
- at a convenient time when the system is not making product, such as during a shift change

An auto-calibration programming example is provided in chapter 6.

Single-point Calibration

Single-point calibration is an optional procedure that can be used to improve the accuracy of the RTD module and cable combination to greater than ± 0.2 °C (32.4 °F) (when the RTD is operating at ± 50 °C (122 °F) of the calibration temperature). The offset, determined by the single-point calibration, can be used to compensate for inaccuracies in the RTD module and cable combination.

After single-point calibration is performed, additional calibrations only need to be performed if the cable is disturbed or degraded. (RTD replacement should not affect the accuracy of the procedure.) However, periodic auto-calibrations should be performed. Follow the steps below to perform a single-point calibration.

1. Cycle power to the SLC 500 chassis.
2. Select a calibration temperature that is near the control point (± 10 °C (50 °F)).
3. Determine the exact resistance (± 0.01 ohm) equivalent to the calibration temperature by using a published temperature vs. resistance chart.
4. Replace the RTD with the fixed-precision resistor. (It is recommended that you use a 2 ppm temperature coefficient resistor.)

5. Use the RTD module to determine the temperature equivalent to the fixed precision resistor and cable combination.
6. Calculate the offset value by subtracting the calculated calibration temperature from the measured temperature.
7. Reconnect the RTD to the cable.
8. Use ladder logic to apply (subtract) the offset from the measured temperature to obtain corrected temperature.

Notes:

Preliminary Operating Considerations

This chapter explains how the RTD module and the SLC processor communicate through the module's input and output image. It lists the preliminary setup and operation required before the RTD module can function in a 1746 I/O system. Topics discussed include how to:

- enter the module ID code.
- address your RTD module.
- select the proper input filter for each channel.
- calculate the RTD module update time.
- interpret the RTD module response to slot disabling.

The module identification code is a unique number encoded for each 1746 I/O module. The code defines for the processor the type of I/O or specialty module residing in a specific slot in the 1746 chassis.

Module ID Code

To manually enter the module ID code, select (other) from the list of modules on the system I/O configuration display. The module ID code for the RTD module, 1746-NR4, is 3513.

No special I/O configuration information is required. The module ID code automatically assigns the correct number of input and output words.

Module Addressing

The memory map displays how the output and input image tables are defined for the RTD module.

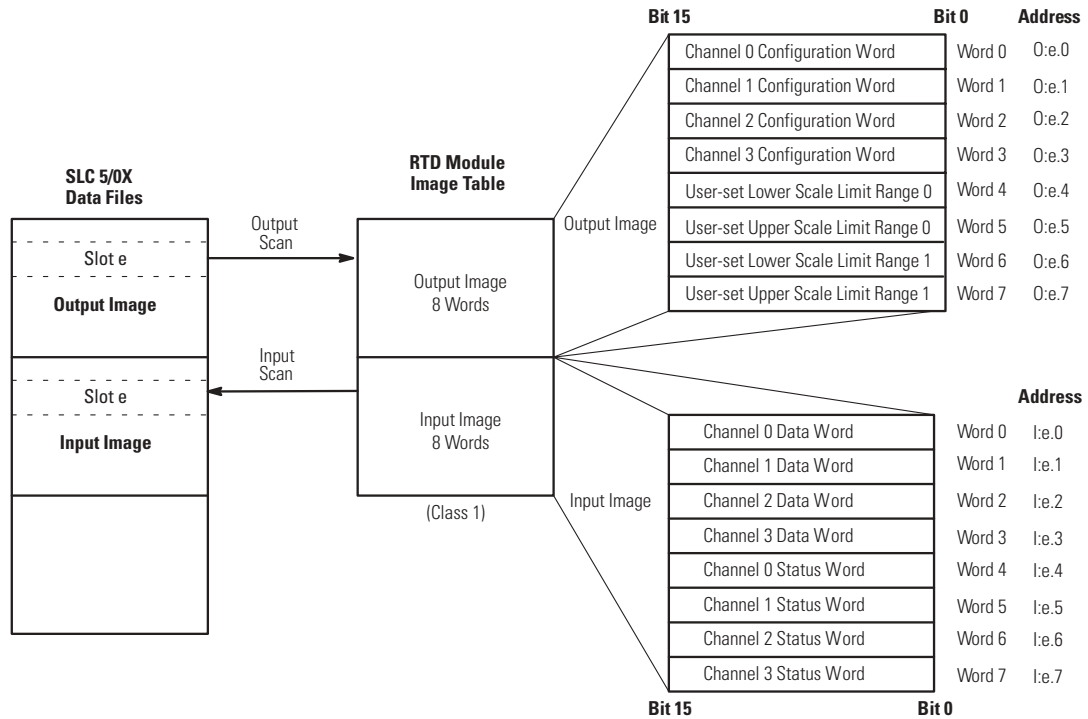

Output Image - Configuration Words

The 8-word, RTD module output image (defined as the output from the CPU to the RTD module) contains information that you configure to define the way a specific channel on the RTD module will work. These words take the place of configuration DIP switches on the module. Although the RTD output image is eight words long, only output words 0...3 are used to define the operation of the module; output words 4...7 are used for special user-set scaling using the proportional counts data format. Each output word 0...3 configures a single channel.

EXAMPLE

If you want to configure channel 2 on the RTD module located in slot 4 in the SLC chassis, your address would be 0:4.2

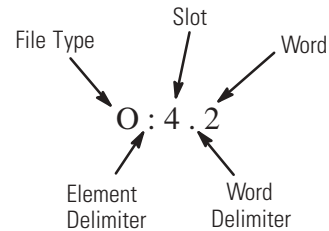

Chapter 5, Channel Configuration, Data, and Status, gives you detailed bit information about the content of the data word and the status word.

Input Image - Data Words and Status Words

The 8-word, RTD module input image (defined as the input from the RTD module to the CPU) represents data words and status words.

Input words 0...3 (data words) hold the input data that represent the temperature value of the RTD input or ohmic value of the resistance inputs for channels 0...3. This data word is valid only when the channel is enabled and there are no channel errors.

Input words 4...7 (status words) contain the status of channels 0...3 respectively. The status bits for a particular channel reflect the configuration settings that you have entered into the output image configuration word for that channel and provide information about the channel's operational state. To receive valid status information, the channel must be enabled and the channel must have processed any configuration changes that may have been made to the configuration word.

EXAMPLE

To obtain the status of channel 2 (input word 6) of the RTD module located in slot 3 in the SLC chassis, use address I:3.6.

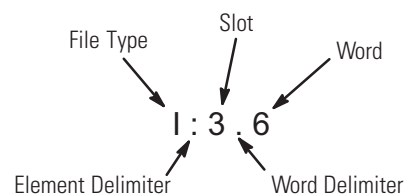

Chapter 5, Channel Configuration, Data, and Status, gives you detailed bit information about the content of the data word and the status word.

The RTD module uses a digital filter that provides noise rejection for the input signals. The digital filter is programmable, allowing you to select from four filter frequencies for each channel. The digital filter provides the highest noise rejection at the selected filter frequency.

Channel Filter Frequency Selection

Selecting a low value (for example, 10 Hz) for the channel filter frequency provides greater noise rejection for a channel, but also increases the channel update time. Selecting a high value for the channel filter frequency provides lesser noise rejection, but decreases the channel update time.

The Notch Frequencies table shows the available filter frequencies, as well as the associated minimum normal mode rejection (NMR), cut-off frequency, and step response for each filter frequency.

The figures on pages 56 and 57 show the input channel frequency response for each filter frequency selection.

Channel Step Response

The channel filter frequency determines the channel's step response. The step response is the time required for the analog input signal to reach 100% of its expected final value. This means that if an input signal changes faster than the channel step response, a portion of that signal will be attenuated by the channel filter. The table below shows the step response for each filter frequency.

Notch Frequencies

Filter Frequency	50 Hz NMR	60 Hz NMR	Cut-off Frequency	Step Response
10 Hz	100 dB	100 dB	2.62 Hz	300 ms
50 Hz	100 dB	-	13.1 Hz	60 ms
60 Hz	-	100 dB	15.72 Hz	50 ms
250 Hz	-	-	65.5 Hz	12 ms

Effective Resolution

The effective resolution for an input channel depends upon the filter frequency selected for that channel. This table displays the effective resolution for the various input types and filter frequencies.

Effective Resolution

Input Type	Filter Frequency			
	10 Hz	50 Hz	60 Hz	250 Hz
100 Ω Pt RTD (385) ⁽¹⁾	± 0.1 °C (± 0.2 °F)	± 0.2 °C (± 0.4 °F)	± 0.2 °C (± 0.4 °F)	± 0.4 °C (± 0.7 °F)
200 Ω Pt RTD (385) ⁽¹⁾	± 0.1 °C (± 0.2 °F)	± 0.2 °C (± 0.4 °F)	± 0.2 °C (± 0.4 °F)	± 0.4 °C (± 0.7 °F)
500 Ω Pt RTD (385) ⁽¹⁾	± 0.1 °C (± 0.2 °F)	± 0.2 °C (± 0.4 °F)	± 0.3 °C (± 0.5 °F)	± 0.4 °C (± 0.7 °F)
1000 Ω Pt RTD (385) ⁽¹⁾	± 0.1 °C (± 0.2 °F)	± 0.2 °C (± 0.4 °F)	± 0.2 °C (± 0.4 °F)	± 0.4 °C (± 0.7 °F)
100 Ω Pt RTD (3916) ⁽¹⁾	± 0.1 °C (± 0.2 °F)	± 0.2 °C (± 0.4 °F)	± 0.2 °C (± 0.4 °F)	± 0.3 °C (± 0.5 °F)
200 Ω Pt RTD (3916) ⁽¹⁾	± 0.1 °C (± 0.2 °F)	± 0.2 °C (± 0.4 °F)	± 0.3 °C (± 0.5 °F)	± 0.3 °C (± 0.5 °F)
500 Ω Pt RTD (3916) ⁽¹⁾	± 0.1 °C (± 0.2 °F)	± 0.2 °C (± 0.4 °F)	± 0.2 °C (± 0.4 °F)	± 0.3 °C (± 0.5 °F)
1000 Ω Pt RTD (3916) ⁽¹⁾	± 0.1 °C (± 0.2 °F)	± 0.2 °C (± 0.4 °F)	± 0.2 °C (± 0.4 °F)	± 0.3 °C (± 0.5 °F)
10 Ω Cu RTD (426) ⁽¹⁾⁽²⁾	± 0.2 °C (± 0.4 °F)	± 0.3 °C (± 0.5 °F)	± 0.3 °C (± 0.5 °F)	± 0.4 °C (± 0.7 °F)
120 Ω Ni RTD (618) ⁽¹⁾⁽³⁾	± 0.1 °C (± 0.2 °F)	± 0.1 °C (± 0.2 °F)	± 0.1 °C (± 0.2 °F)	± 0.2 °C (± 0.4 °F)
120 Ω Ni RTD (672) ⁽¹⁾	± 0.1 °C (± 0.2 °F)	± 0.1 °C (± 0.2 °F)	± 0.1 °C (± 0.2 °F)	± 0.3 °C (± 0.5 °F)
604 Ω NiFe RTD (518) ⁽¹⁾	± 0.1 °C (± 0.2 °F)	± 0.1 °C (± 0.2 °F)	± 0.1 °C (± 0.2 °F)	± 0.2 °C (± 0.4 °F)
150 Ω Resistance Input	± 0.02 Ω	± 0.04 Ω	± 0.04 Ω	± 0.08 Ω
500 Ω Resistance Input	± 0.1 Ω	± 0.2 Ω	± 0.2 Ω	± 0.4 Ω
1000 Ω Resistance Input	± 0.2 Ω	± 0.3 Ω	± 0.3 Ω	± 0.5 Ω
3000 Ω Resistance Input	± 0.2 Ω	± 0.3 Ω	± 0.3 Ω	± 0.5 Ω

⁽¹⁾ The digits following the RTD type represent the temperature coefficient of resistance (μ), which is defined as the resistance change per ohm per °C. For instance, Platinum 385 refers to a platinum RTD with $\mu = 0.00385$ ohms/ohm - °C or simply 0.00385 /°C.

⁽²⁾ Actual value at 0 °C (32 °F) is 9.042 Ω per SAMA standard RC21-4-1966.

⁽³⁾ Actual value at 0 °C (32 °F) is 100 Ω per DIN standard.

Channel Cut-off Frequency

The channel filter frequency selection determines a channel's cut-off frequency, also called the -3 dB frequency. The cut-off frequency is defined as the point on the input channel frequency response curve where frequency components of the input signal are passed with 3 dB of attenuation. All frequency components at or below the cut-off frequency are passed by the digital filter with less than 3 dB of attenuation. All frequency components above the cut-off frequency are increasingly attenuated, as shown in the following figures.

The cut-off frequency for each input channel is defined by its filter frequency selection. The Notch Frequencies table shows the input channel cut-off frequency for each filter frequency. Choose a filter frequency so that your fastest changing signal is below that of the filter's cut-off frequency. The cut-off frequency should not be confused with update time. The cut-off frequency relates how the digital filter attenuates frequency components of the input signal. The update time defines the rate at which an input channel is scanned and its channel data word updated.

See page 58 for determining the channel update time.

10 Hz Filter Notch Frequency

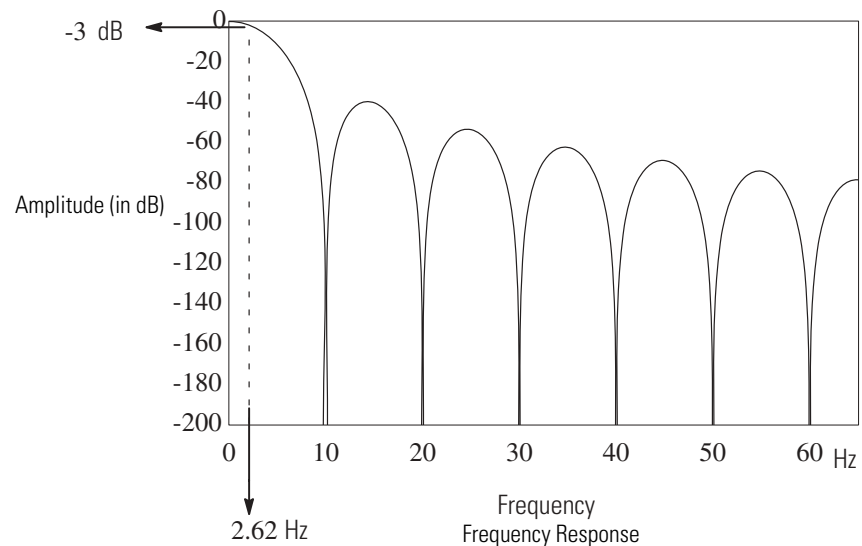

50 Hz Filter Notch Frequency

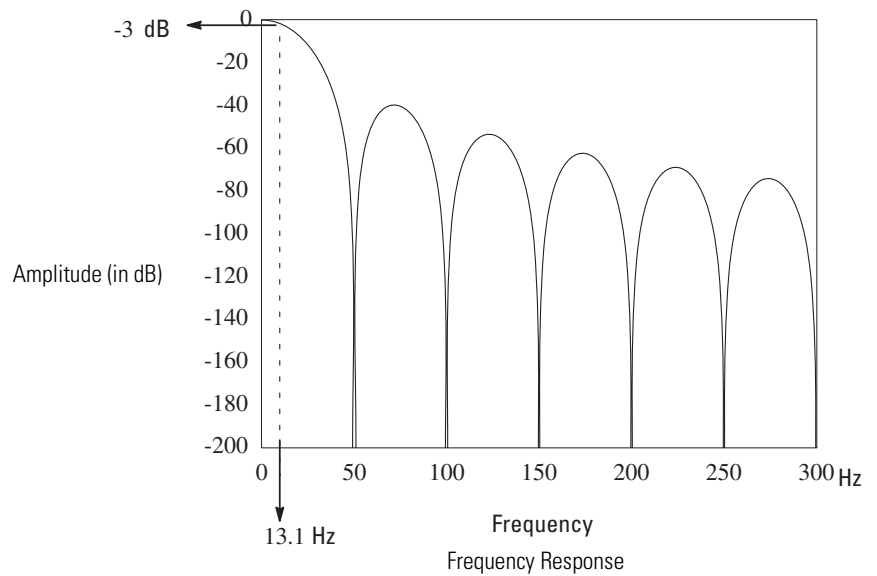

60 Hz Filter Notch Frequency

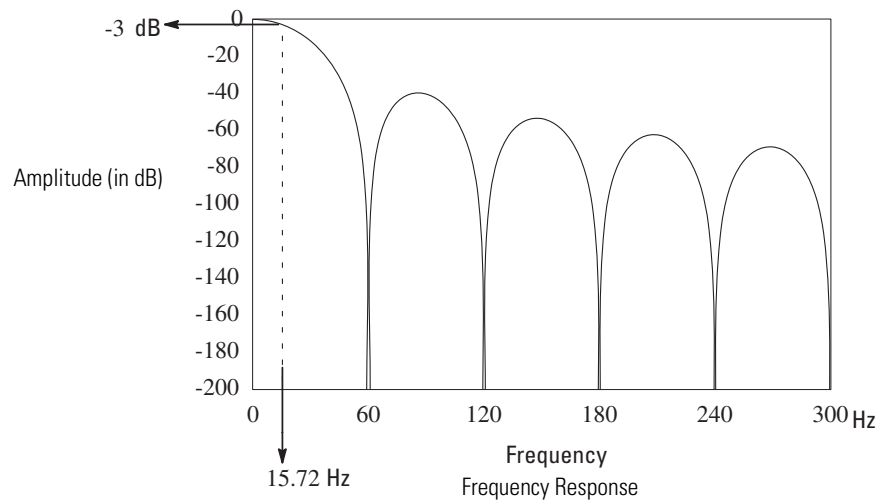

250 Hz Filter Notch Frequency

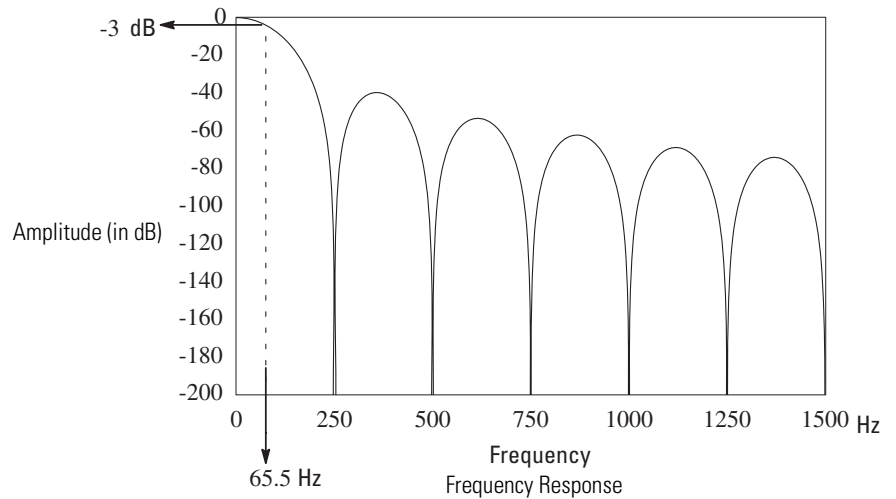

Scanning Process and Channel Timing

This section shows how to determine the channel update time and channel autocalibration time. In addition, the scanning process is briefly described.

The RTD module channel update time is defined as the time required for the module to sample and convert (scan) the input signal of an enabled input channel and make the resulting data value available to the SLC processor for update.

Channel Autocalibration

Upon entry into the channel enabled state, the corresponding channel is calibrated and configured according to the channel configuration word information. Channel calibration takes precedence over channel scanning and is a function of the selected notch filter.

Channel Calibration Time

Filter Frequency	Channel Calibration Time
10 Hz	7300 ms
50 Hz	1540 ms
60 Hz	1300 ms
250 Hz	388 ms

Update Time and Scanning Process

Scanning Cycle on page 60 shows the scanning process for the RTD module assuming that the module is running normally and more than one channel is enabled.

The scanning cycle is shown for the situation where channels 0 and 1 are enabled and channels 2 and 3 are not used.

IMPORTANT

The scanning process shown on is similar for any number of enabled channels.

Channel scanning is sequential and always occurs starting with the lowest numbered enabled channel and proceeding to the next highest numbered channel, for example, channel 0 - channel 1 - channel 2 - channel 3 - channel 0 - channel 1. Channel scan time is a function of the filter frequency.

Channel Scan Time

Filter Frequency	Channel Scan Time ⁽¹⁾
10 Hz	305 ms
50 Hz	65 ms
60 Hz	55 ms
250 Hz	17 ms

⁽¹⁾ The module-scan time is obtained by summing the channel-scan time for each enabled channel. For example, if 3 channels are enabled and the 50 Hz filter is selected, the module-scan time is 3 X 65 ms = 195 ms.

The fastest module update time occurs when only one channel with a 250 Hz filter frequency is enabled.

$$\text{Module Update Time} = 17 \text{ ms}$$

TIP

With 3 channels enabled, the module update time is: 3 channels_ 17 ms/channel = 51 ms

The slowest module update time occurs when four channels, each using a 10 Hz filter frequency, are enabled.

$$\text{Module Update Time} = 4 _ 305 \text{ ms} = 1220 \text{ ms}$$

Scanning Cycle

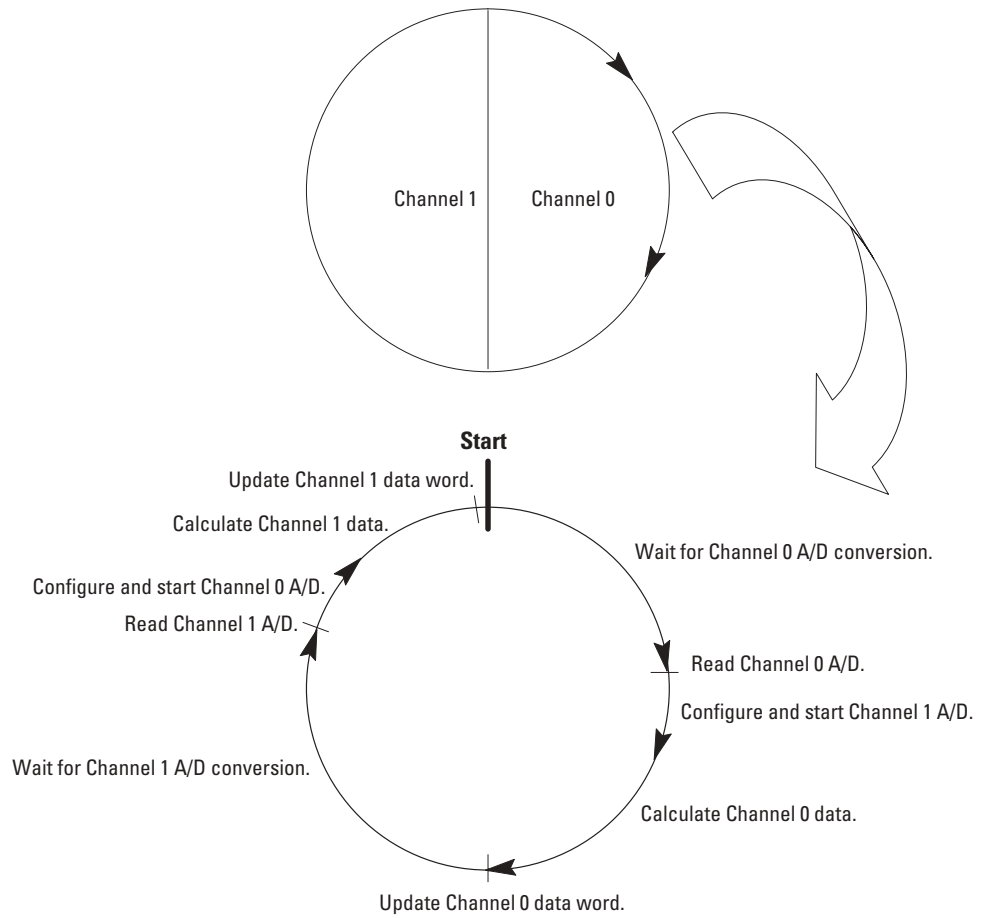

Scan Cycle With Channels 0 and 1 Enabled Only

Channel Turn-on, Turn-off, and Reconfiguration Time

The table below gives you the turn-on, turn-off, and reconfiguration times for enabling or disabling a channel.

Function	Description	Duration
Turn-on Time	The time it takes to make converted data available in the data word and to set the status bit (transition from 0 to 1) in the status word, after setting the enable bit in the configuration word.	Requires up to one module update time plus one of the following: <ul style="list-style-type: none"> • 250 Hz Filter = 388 ms • 60 Hz Filter = 1300 ms • 50 Hz Filter = 1540 ms • 10 Hz Filter = 7300 ms
Turn-off Time	The time it takes to reset the status bit (transition from 1 to 0) in the status word and to zero the data word, after resetting the enable bit in the configuration word.	Requires up to one module update time.
Reconfiguration Time	The time it takes to change a channel configuration if the device type, filter frequency, or excitation current is different from the current setting. The enable bit remains in a steady state of 1. (Changing temperature/resistance units or data format does not require reconfiguration time.)	Requires up to one module update time plus one of the following: <ul style="list-style-type: none"> • 250 Hz Filter = 124 ms • 60 Hz Filter = 504 ms • 50 Hz Filter = 604 ms • 10 Hz Filter = 3,004 ms

Response to Slot Disabling

By writing to the status file in your modular SLC processor you can disable any chassis slot. Refer to your SLC programming manual for the slot disable/enable procedure.

ATTENTION



Always understand the implications of disabling a RTD module in your application before using the slot disable feature.

Input Response

When a RTD slot is disabled, the RTD module continues to update its input image table. However, the SLC processor does not read inputs from a module that is disabled. Therefore, when the processor disables the RTD module slot, the module inputs appearing in the processor input image remain in their last state and the module's updated image table is not read. When the processor re-enables the module slot, the current state of the module inputs are read by the processor during the subsequent scan.

Output Response

The SLC processor may change the RTD module output data (configuration) as it appears in the processor output image. However, this data is not transferred to the RTD module when the slot is disabled. The outputs are held in their last state. When the slot is re-enabled, the data in the processor image is transferred to the RTD module.

Channel Configuration, Data, and Status

This chapter examines the channel configuration word and the channel status word bit by bit. It explains how the module uses configuration data and generates status during operation. It gives you information about how to:

- configure a channel.
- examine channel input data.
- check a channel's status.

Channel Configuration

The channel configuration word is a part of the RTD module's output image. Output words 0...3 correspond to channels 0...3 on the module. Setting the condition of bits 0...15 in these words via your ladder logic program causes the channel to operate as you choose (for example, RTD type or reading in °C). Output words 4...7 are used to further define the channel configuration to let you choose a scaling format other than the module default when using the proportional counts data format. You can use words 4 and 5 to define one user-set range and words 6 and 7 to define a second range.

A bit-by-bit examination of the configuration word is provided in the Channel Configuration Word (O:e.0 through O:e.3) - Bit Definitions table on page 66. Programming is discussed in chapter 6. Addressing is explained in chapter 4.

Module Output Image (Configuration Word)

O:e.0	CH 0 Configuration Word															
	15								0							
O:e.1	CH 1 Configuration Word															
	15								0							
O:e.2	CH 2 Configuration Word															
	15								0							
O:e.3	CH 3 Configuration Word															
	15								0							
O:e.4	Defines user±set lower scale limit for range 0															
	15								0							
O:e.5	Defines user±set upper scale limit for range 0															
	15								0							
O:e.6	Defines user±set lower scale limit for range 1															
	15								0							
O:e.7	Defines user±set upper scale limit for range 1															
	15								0							

Module default settings for configuration words 0...7 are all zeros.

Scaling defaults are explained on page 78 under the explanation for the Scaling Select (Bits 13-14).

The channel configuration word consists of bit fields, the settings of which determine how the channel operates. This procedure looks at each bit field separately and helps you configure a channel for operation.

Refer to the Channel Configuration Word (O:e.0 through O:e.3) - Bit Definitions table on page 66 and the bit field descriptions that follow for complete configuration information. Page 128 contains a configuration worksheet that can assist your channel configuration.

Channel Configuration Procedure

The following sections give you procedures to configure the channels.

Configure Each Channel

1. Determine the input device type (RTD type or resistance input) for a channel and enter its respective four-digit binary code in bit field 0...3 (Input Type Selection) of the channel configuration word.
2. Select a data format for the data word value.

Your selection determines how the analog input value from the A/D converter is expressed in the data word.

3. Enter your two-digit binary code in bit field 4...5 (Data Format Selection) of the channel configuration word.

Depending upon how you configure these bit settings, you may have to select a user-set scaling range.

User-set Scaling Using Proportional Counts Data Format on page 80 gives an example on how to do this.

4. Determine the desired state for the channel data word if a broken input condition is detected for that channel (open circuit or short circuit).
5. Enter the two-digit binary code in bit field 6 and 7 (Broken Input Selection) of the channel configuration word.

6. If the channel is configured for RTD inputs and engineering units data format, determine if you want the channel data word to read in ° C or ° F and enter a one or a zero in bit 8 (Temperature Units) of the configuration word.

If the channel is configured for a resistance input, this field is ignored.

7. Determine the desired input filter frequency for the channel and enter the two-digit binary code in bit field 9 and 10 (Filter Frequency Selection) of the channel configuration word.

A lower filter frequency increases the channel update time, but also increases the noise rejection and channel resolution. A higher filter frequency decreases the channel update time, but also decreases the noise rejection and channel resolution.

8. Place a one in bit 11 (channel Enable) if the channel is used or place a zero in bit 11 if the channel is not used.
9. Place a zero in bit 12 for an excitation current of 2.0 mA or place a one in bit 12 for 0.5 mA.

Select the excitation current value based on RTD vendor recommendations and the Input Specifications table, on page 118.

10. If you have chosen proportional counts data format, select whether you want the module-defined default scaling selected for each channel or if you want to define the scaling range yourself. Use bits 13 and 14 (user-set scaling) for this setting. If you choose to define the scaling range for proportional counts data format, make sure to enter the lower and upper limits in words 4 and 5 (defines range 0) or 6 and 7 (defines range 1).
11. Place a zero in bit 15 because this bit is not used.
12. Build the channel configuration word using the configuration worksheet on page 128 for every channel on each RTD module repeating the procedures given in steps 1...11.

Enter the Configuration Data

Follow the steps outlined in Chapter 2, Quick Start Guide; Chapter 6, Ladder Programming Examples; or Appendix D, Channel Configuration, Data, and Status.

Enter your configuration data into your ladder program and copy it to the RTD module.

Channel Configuration Word (0:e.0 through 0:e.3) - Bit Definitions

Bit(s)	Define	To select	Make these bit settings in the Channel Configuration Word																		
			15	14	13	12	11	10	9	8	7	6	5	4	3	2	1	0			
0...3	Input type selection	100 ΩPt RTD (385)	Not U													0	0	0	0		
		200 ΩPt RTD (385)															0	0	0	1	
		500 ΩPt RTD (385)																0	0	1	0
		1000 ΩPt RTD (385)																0	0	1	1
		100 ΩPt RTD (3916)																0	1	0	0
		200 ΩPt RTD (3916)																0	1	0	1
		500 ΩPt RTD (3916)																0	1	1	0
		1000 ΩPt RTD (3916)																0	1	1	1
		10 Ω Cu RTD (426) ⁽¹⁾																1	0	0	0
		120 Ω Ni RTD (618) ⁽²⁾																1	0	0	1
		120 Ω Ni RTD (672)																1	0	1	0
		604 ΩNiFe RTD (518)																1	0	1	1
		150 Ω Resistance Input																1	1	0	0
		500 Ω Resistance Input																1	1	0	1
		1000 Ω Resistance Input																1	1	1	0
3000 Ω Resistance Input															1	1	1	1			
4...5	Data format selection	Engineering units X 1 ⁽³⁾	Not Used												0	0					
		Engineering units X 10 ⁽⁴⁾													0	1					
		Scaled-for-PID														1	0				
		proportional counts														1	1				
6...7	Broken input selection	Set to Zero													0	0					
		Set to Upscale													0	1					
		Set to Downscale														1	0				
		Invalid														1	1				
8	Temperature units selection	Degrees C ⁽⁵⁾									0										
		Degrees F ⁽⁵⁾								1											
9...10	Filter frequency selection	10 Hz						0	0												
		50 Hz						0	1												
		60 Hz						1	0												
		250 Hz						1	1												
11	Channel enable	Channel Disabled						0													
		Channel Enabled						1													
13...14	Scaling selection	Default Scaling	Not used	0	0																
		User-set Scaling (Range 0) ⁽⁶⁾		0	1																
		User-set Scaling (Range 1) ⁽⁶⁾		1	0																
		Invalid		1	1																
15	Unused	Unused ⁽⁷⁾		0																	

(1) Actual value at 0 °C (32 °F) is 9.072 Ω per SAMA standard RC21-4-1966.
 (2) Actual value at 0 °C (32 °F) is 100 Ω per DIN standard.
 (3) Values are in 0.1 degree/step or 0.1 Ω/step for all resistance types, except 150 Ω. For the 150 Ω resistance input type, the values are in 0.01 Ω/step.
 (4) Values are in 1 degree/step or 1 Ω/step for all resistance input types, except 150 Ω. For the 150 Ω resistance input type, the values are in 0.01 Ω/step.
 (5) This bit is ignored when a resistance device is selected.
 (6) Applies to proportional counts data format selected using bits 4 and 5.
 (7) Ensure unused bit 15 is always set to zero.

Input Type Selection (Bits 0...3)

The input type bit field lets you configure the channel for the type of input device you have connected to the module. Valid input devices are shown in the Channel Configuration Word (O:e.0 through O:e.3) - Bit Definitions table.

Data Format Selection (Bits 4 and 5)

The data format bit field lets you define the format for the channel data word contained in the module input image. Valid data types are engineering units, scaled-for-PID, and proportional counts. If you select proportional counts, you have the option of using user-set scaling bits 13 and 14 (Table Channel Configuration Word (O:e.0 through O:e.3) - Bit Definitions) to define an optimum range for your application. Unless you specify otherwise, the data will be scaled to the full scale range for that channel.

Bit Descriptions for Data Format Select

Binary Value	Select	Description
00	Engineering units x 1	Expresses values in 0.1 ° or 0.1 Ω for 150 Ω pot., only.
01	Engineering units x10	Express values in 1 ° or 1 Ω or 0.1 Ω for 150 Ω pot. only.
10	Scaled-for-PID	The input signal range for the selected input type is its full scale input range. The signal range is scaled into a 0...16,383 range, which is what the SLC processor expects in the PID function.
11	Proportional counts	The input signal range is proportional to your selected input type and scaled into a -32,768...32,767 range (default) or user-set range, based on the scaling select bits (13 and 14) and scale limit words (O:e.4/O:e.5 or O:e.6/O:e.7).

Using Scaled-for-PID and Proportional Counts Formats

The RTD module provides eight options for displaying input channel data. These are 0.1 °F, 0.1 °C, 1 °F, 1 °C, 0.1 Ω , 1 Ω Scaled-for-PID, and Proportional Counts. The first six options represent real engineering units and do not require explanation. The Scaled-for-PID selection allows you to directly interface RTD Data into a PID instruction without intermediate scale operations. The Proportional Counts selection provides the highest display resolution, but also require you to manually convert the channel data to real Engineering Units.

Default scaling can be selected for scaled-for-PID data format and proportional counts data format. User-set scaling can be selected for proportional counts data format.

For a description of default scaling, see Scaled-for-PID and Proportional Counts Data Format. For a description of user-set scaling using proportional counts data format, see page 67.

The equations on page 71 show how to convert from Scaled-for-PID to Engineering Units, Engineering Units to Scaled-for-PID, Proportional Counts to Engineering Units, and Engineering Units to Proportional Counts.

To perform the conversions, you must know the defined temperature or resistance range for the channel's input type.

Refer to the Channel Data Word Format in the tables on pages 72...73. The lowest possible value for an input type is S_{LOW} , and the highest possible value is S_{HIGH} .

Scaled-for-PID

If the user selects scaled-for-PID as the data format, the data word for that channel is a number between 0...16,383. Zero (0) corresponds to the lowest temperature value of the RTD type or the lowest resistance value (ohms). The value 16,383 corresponds to the highest temperature value for that RTD or the highest resistance value (ohms). For example, if a 100 Ω Platinum RTD ($a = 0.003916$) is selected, then the relationship of temperature and module counts is shown in the following table.

Relationship Between Temperature and Counts

Temperature	Counts
-200 °C (-328 °F)	0
+630 °C (1166 °F)	16383

The Linear Relationship Between Temperature and PID Counts graph shows the linear relationship between output counts and temperature when one uses scaled-for-PID data format.

Linear Relationship Between Temperature and PID Counts

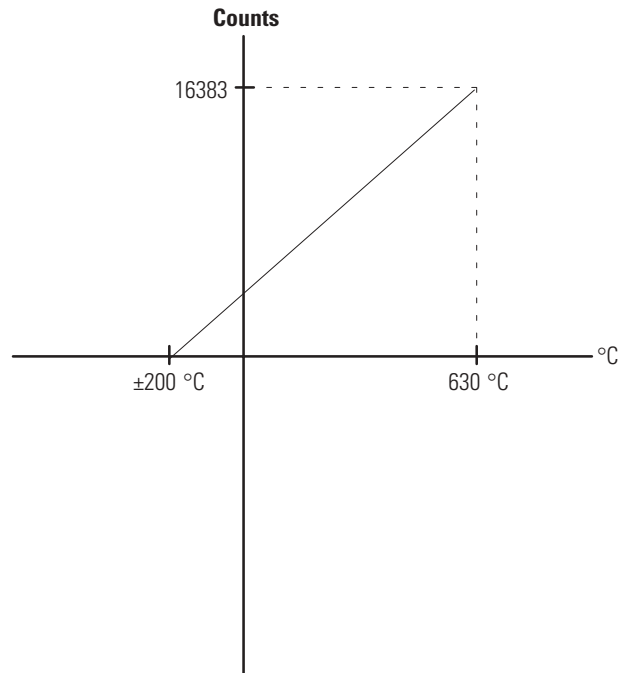

Proportional Counts Data Format

If the user selects proportional counts data format, the data word for that channel is a number between -32,768 and 32,767. This provides the greatest resolution of all scaling options. The value -32,768 corresponds to the lowest temperature value of the RTD type or the lowest resistance value (ohms). The value 32,767 corresponds to the highest temperature value for that RTD or the highest resistance value (ohms). For example, if a 100 Ω Platinum RTD (3916) is selected, then the relationship of temperature and module counts is shown in the following table.

Relationship Between Temperature and Counts

Temperature	Counts
-200 °C (-328 °F)	-32,768
+630 °C (1166 °F)	+32,767

The Linear Relationship Between Temperature and Proportional Counts graph shows the linear relationship between output counts and temperature when one uses proportional counts data format.

Linear Relationship Between Temperature and Proportional Counts

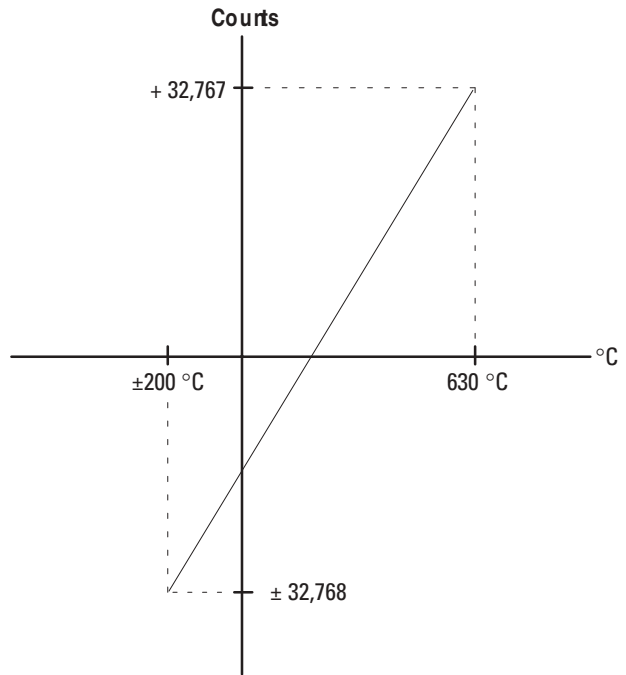

Scaling Examples

The following examples are using the default scaling ranges.

Scaled-for-PID to Engineering Units

Equation $\text{Engr Units Equivalent} = S_{\text{LOW}} + [(S_{\text{HIGH}} - S_{\text{LOW}}) \times (\text{Scaled-for-PID value displayed} / 16383)]$

Assume that the input type is an RTD, Platinum (200 Ω a = 0.00385 $^{\circ}\text{C}$, range = -200 $^{\circ}\text{C}$...850 $^{\circ}\text{C}$), scaled-for-PID display type. Channel data = 3421.

Want to calculate $^{\circ}\text{C}$ equivalent.

From Channel Data Word Format (Table Data Formats for RTD Temperature Ranges for 0.5 and 2.0 mA Excitation Current through Table Data Format for 500 Ω Resistance Input), $S_{\text{LOW}} = -200$ $^{\circ}\text{C}$ and $S_{\text{HIGH}} = 850$ $^{\circ}\text{C}$.

Solution $\text{Engr Units Equivalent} = -200$ $^{\circ}\text{C} + [(850$ $^{\circ}\text{C} - (-200$ $^{\circ}\text{C})) \times (3421 / 16383)] = 19.25$ $^{\circ}\text{C}$.

Engineering Units to Scaled-for-PID

Equation $\text{Scaled-for-PID Equivalent} = 16383 \times [(\text{Engineering Units desired} - S_{\text{LOW}}) / (S_{\text{HIGH}} - S_{\text{LOW}})]$

Assume that the input type is an RTD, Platinum (200 Ω a = 0.00385 $^{\circ}\text{C}$, range = -200 $^{\circ}\text{C}$...850 $^{\circ}\text{C}$), scaled-for-PID display type. Desired channel temp. = 344 $^{\circ}\text{C}$.

Want to calculate Scaled-for-PID equivalent.

From Channel Data Word Format (Table Data Formats for RTD Temperature Ranges for 0.5 and 2.0 mA Excitation Current through Table Data Format for 500 Ω Resistance Input), $S_{\text{LOW}} = -200$ $^{\circ}\text{C}$ and $S_{\text{HIGH}} = 850$ $^{\circ}\text{C}$.

Solution $\text{Scaled-for-PID Equivalent} = 16383 \times [(344$ $^{\circ}\text{C} - (-200$ $^{\circ}\text{C})) / (850$ $^{\circ}\text{C} - (-200$ $^{\circ}\text{C}))] = 8488$.

Proportional Counts to Engineering Units

Equation $\text{Engr Units Equivalent} = S_{\text{LOW}} + \{(S_{\text{HIGH}} - S_{\text{LOW}}) \times [(\text{Proportional Counts value displayed} + 32768) / 65536]\}$

Assume that input type is a potentiometer (1000 Ω range = 0 to 1000 Ω), proportional counts display type. Channel data = 21567.

Want to calculate ohms equivalent.

From Channel Data Word Format (Table Data Formats for RTD Temperature Ranges for 0.5 and 2.0 mA Excitation Current through Table Data Format for 500 Ω Resistance Input), $S_{\text{LOW}} = 0$ Ω and $S_{\text{HIGH}} = 1000$ Ω

Solution $\text{Engr Units Equivalent} = 0$ $\Omega + \{[1000\Omega - (0$ $\Omega)] \times [(21567 + 32768) / 65536]\} = 829$ Ω

Engineering Units to Proportional Counts

Equation $\text{Proportional Counts Equivalent} = \{65536 \times [(\text{Engineering Units desired} - S_{\text{LOW}}) / (S_{\text{HIGH}} - S_{\text{LOW}})]\} - 32768$

Assume that input type is a potentiometer (3000 Ω range = 0 to 3000 Ω), proportional counts display type.

Desired channel resistance value = 1809 Ω

Want to calculate Proportional Counts equivalent.

From Channel Data Word Format (Table Data Formats for RTD Temperature Ranges for 0.5 and 2.0 mA Excitation Current through Table Data Format for 500 Ω Resistance Input), $S_{\text{LOW}} = 0$ Ω and $S_{\text{HIGH}} = 3000$ Ω

Solution $\text{Proportional Counts Equivalent} = \{65536 \times [(1809$ $\Omega - (0$ $\Omega)) / (3000$ $\Omega - (0\Omega))]\} - 32768 = 6750$.

The Data Formats for RTD Temperature Ranges for 0.5 and 2.0 mA Excitation Current table shows the temperature ranges of several 1746-NR4 RTDs. The table applies to both 0.5 and 2.0 mA excitation currents. The temperature ranges of the remaining RTD units vary with excitation current, for example, 1000 Ω Platinum 385 (table Data Format for 1000 Ω Platinum RTD (385)), 1000 Ω Platinum 3916 (table Data Format for 1000 Ω Platinum RTD (3916)) and 10 Ω Copper 426 (table Data Format for 10 Ω Copper 426 RTD).

Data Formats for RTD Temperature Ranges for 0.5 and 2.0 mA Excitation Current

RTD Input Type	Data Format					
	Engineering Units x 1		Engineering Units x 10		Scaled-for-PID	Proportional Counts (Defaults)
	0.1 °C	0.1 °F	1.0 °C	1.0 °F		
100 Ω Platinum (385)	-2000...8500	-3280...15,620	-200...850	-328...1562	0 ... 16,383	-32,768 ... 32,767
200 Ω Platinum (385)	-2000...8500	-3280...15,620	-200...850	-328...1562	0 ... 16,383	-32,768 ... 32,767
500 Ω Platinum (385)	-2000...8500	-3280...15,620	-200...850	-328...1562	0 ... 16,383	-32,768 ... 32,767
100 Ω Platinum (3916)	-2000...6300	-3280...11,660	-200...630	-328...1166	0 ... 16,383	-32,768 ... 32,767
200 Ω Platinum (3916)	-2000...6300	-3280...11,660	-200...630	-328...1166	0 ... 16,383	-32,768 ... 32,767
500 Ω Platinum (3916)	-2000...6300	-3280...11,660	-200...630	-328...1166	0 ... 16,383	-32,768 ... 32,767
120 Ω Nickel (672)	-800...2600	-1120...5000	-80...260	-112...500	0 ... 16,383	-32,768 ... 32,767
120 Ω Nickel (618)	-1000...2600	-1480...5000	-100...260	-148...500	0 ... 16,383	-32,768 ... 32,767
604 Ω Nickel Iron (518)	-1000...2000	-1480...3920	-100...200	-148...392	0 ... 16,383	-32,768 ... 32,767

Data Format for 1000 Ω Platinum RTD (385)

Excitation Current	Data Format					
	Engineering Units x 1		Engineering Units x 10		Scaled-for-PID	Proportional Counts (Defaults)
	0.1 °C	0.1 °F	1.0 °C	1.0 °F		
0.5 mA	-2000...8500	-3280...15620	-200...850	-328...1562	0...16,383	-32,768...32,767
2.0 mA	-2000...2400	-3280...4640	-200...240	-328...464	0...16,383	-32,768...32,767

Data Format for 1000 Ω Platinum RTD (3916)

Excitation Current	Data Format					
	Engineering Units x 1		Engineering Units x 10		Scaled-for-PID	Proportional Counts (Defaults)
	0.1 °C	0.1 °F	1.0 °C	1.0 °F		
0.5 mA	-2000...6300	-3280...11,660	-200...630	-328...1166	0 ... 16,383	-32,768...32,767
2.0 mA	-2000...2300	-3280...44,600	-200...230	-328...446	0 ... 16,383	-32,768...32,767

Data Format for 10 Ω ⁽¹⁾ Copper 426 RTD

Excitation Current	Data Format					Proportional Counts (Defaults)
	Engineering Units x 1		Engineering Units x 10		Scaled-for-PID	
	0.1 °C	0.1 °F	1.0 °C	1.0 °F		
0.5 mA not allowed	---	---	---	---	---	---
2.0 mA	-1000...2600	-1480...5000	-100...260	-148...500	0...16,383	-32,768...32,767

⁽¹⁾ Actual value at 0 °C (32 °F) is 9.042 Ω per SAMA standard RC21-4-1966.

The Data Format for 150 Ω Resistance Input table, the Data Format for 500 Ω Resistance Input table and the Data Format for 3000 Ω Resistance Input table show the resistance ranges provided by the 1746-NR4.

Data Format for 150 Ω Resistance Input

Resistance Input Type	Data Format			
	Engineering Units x 1	Engineering Units x 10	Scaled-for-PID	Proportional Counts (Defaults)
	0.1 Ω ⁽¹⁾	1.0 Ω ⁽¹⁾		
150 Ω	0...15,000	0...1500	0...16,383	-32,768...32,767

⁽¹⁾ When ohms are selected, the temperature-units selection (bit 8) is ignored.

Data Format for 500 Ω Resistance Input

Resistance Input Type	Data Format			
	Engineering Units x 1	Engineering Units x 10	Scaled-for-PID	Proportional Counts (Defaults)
	0.1 Ω ⁽¹⁾	1.0 Ω ⁽¹⁾		
500 Ω	0...30,000	0...3000	0...16,383	-32,768...32,767
1000 Ω	0...19,000	0...1900	0...16,383	-32,768...32,767

⁽¹⁾ When ohms are selected, the temperature-units selection (bit 8) is ignored.

Data Format for 3000 Ω Resistance Input

Excitation Current	Data Format			
	Engineering Units x 1	Engineering Units x 10	Scaled-for-PID	Proportional Counts (Defaults)
	0.1 Ω ⁽¹⁾	1.0 Ω ⁽¹⁾		
0.5 mA	0...30,000	0...3000	0...16,383	-32,768...32,767
2.0 mA	0...19,000	0...1900	0...16,383	-32,768...32,767

⁽¹⁾ When ohms are selected, the temperature-units selection (bit 8) is ignored.

The Channel Data Word Resolution for RTDs table shows the data resolution provided by the 1746-NR4 for RTD input types using the various data formats.

Channel Data Word Resolution for RTDs

RTD Input Type	Data Format (Bits 4 and 5) ⁽¹⁾							
	Engineering Units x 1		Engineering Units x 10		Scaled-for-PID		Proportional Counts (Defaults)	
	°C	°F	°C	°F	°C	°F	°C	°F
100 Ω Platinum 385	0.1 °C/step	0.1 °F/step	1 °C/step	1 °F/step	0.0641 °C/step	0.1154 °F/step	0.0160 °C/step	0.0288 °F/step
200 Ω Platinum 385	0.1 °C/step	0.1 °F/step	1 °C/step	1 °F/step	0.0641 °C/step	0.1154 °F/step	0.0160 °C/step	0.0288 °F/step
500 Ω Platinum 385	0.1 °C/step	0.1 °F/step	1 °C/step	1 °F/step	0.0641 °C/step	0.1154 °F/step	0.0160 °C/step	0.0288 °F/step
1000 Ω Platinum 385	0.1 °C/step	0.1 °F/step	1 °C/step	1 °F/step	0.0641 °C/step	0.1154 °F/step	0.0160 °C/step	0.0288 °F/step
100 Ω Platinum 3916	0.1 °C/step	0.1 °F/step	1 °C/step	1 °F/step	0.0507 °C/step	0.0912 °F/step	0.0127 °C/step	0.0288 °F/step
200 Ω Platinum 3916	0.1 °C/step	0.1 °F/step	1 °C/step	1 °F/step	0.0507 °C/step	0.0912 °F/step	0.0127 °C/step	0.0288 °F/step
500 Ω Platinum 3916	0.1 °C/step	0.1 °F/step	1 °C/step	1 °F/step	0.0507 °C/step	0.0912 °F/step	0.0127 °C/step	0.0288 °F/step
1000 Ω Platinum 3916	0.1 °C/step	0.1 °F/step	1 °C/step	1 °F/step	0.0507 °C/step	0.0912 °F/step	0.0127 °C/step	0.0288 °F/step
10 Ω Copper 426	0.1 °C/step	0.1 °F/step	1 °C/step	1 °F/step	0.0220 °C/step	0.0396 °F/step	0.0051 °C/step	0.0099 °F/step
120 Ω Nickel 618 ⁽²⁾	0.1 °C/step	0.1 °F/step	1 °C/step	1 °F/step	0.0220 °C/step	0.0396 °F/step	0.0051 °C/step	0.0099 °F/step
120 Ω Nickel 672	0.1 °C/step	0.1 °F/step	1 °C/step	1 °F/step	0.0208 °C/step	0.0374 °F/step	0.0052 °C/step	0.0093 °F/step
604 Ω Nickel Iron 518	0.1 °C/step	0.1 °F/step	1 °C/step	1 °F/step	0.0183 °C/step	0.0330 °F/step	0.0046 °C/step	0.0082 °F/step

⁽¹⁾ When ohms are selected, the temperature-units selection (bit 8) is ignored. Analog input data is the same for either °C or °F selection.

⁽²⁾ Actual value at 0 °C (32 °F) is 100Ω per DIN standard.

The Channel Data Word Resolution for 150 Ω Resistance Input table and the Channel Data Word Resolution for 500 Ω, 1000 Ω, and 3000 Ω Resistance Inputs table shows the data resolution provided by the 1746-NR4 for resistance input types using the various data formats.

Channel Data Word Resolution for 150 Ω Resistance Input

Resistance Input Type	Data Format (Bits 4 and 5)			
	Engineering Units x 1	Engineering Units x 10	Scaled-for-PID	Proportional Counts (Defaults)
	Ohms	Ohms	Ohms	Ohms
150 Ω	0.01 Ω/ step	0.1 Ω/ step	0.0092 Ω/ step	0.0023 Ω/ step

Channel Data Word Resolution for 500 Ω , 1000 Ω , and 3000 Ω Resistance Inputs

Resistance Input Type	Data Format (Bits 4 and 5)			
	Engineering Units x 1	Engineering Units x 10	Scaled-for-PID	Proportional Counts (Defaults)
	Ohms	Ohms	Ohms	Ohms
500 Ω	0.1 Ω / step	0.1 Ω / step	0.0305 Ω / step	0.0076 Ω / step
1000 Ω	0.1 Ω / step	0.1 Ω / step	0.0610 Ω / step	0.0153 Ω / step
3000 Ω	0.1 Ω / step	0.1 Ω / step	0.1831 Ω / step	0.0458 Ω / step

Broken Input Selection (Bits 6 and 7)

The Bit Descriptions for Broken Input Selection table shows the descriptions for bits 6 and 7. The broken input bit field lets you define the state of the channel data word when an open-circuit or short-circuit condition is detected for that channel.

An open-circuit condition occurs when the RTD or potentiometer or its extension wire is physically separated or opened. This can happen if the wire is cut or disconnected from the terminal block.

The short-circuit condition applies only to RTD input types. This can happen if the RTD or its signal wires are shorted together for any reason. The short-circuit condition does not apply to resistance ranges since they start at 0 ohms, which can be a short-circuit condition.

Bit Descriptions for Broken Input Selection

Binary Value	Select	Description
00	zero	Force the channel data word to 0 during an open-circuit condition or short-circuit condition.
01	upscale	Force the channel data word value to its full scale during an open-circuit or short-circuit condition. The full scale value is determined by the input type, data format, and scaling selected.
10	downscale	Force the channel data word value to its low scale value during an open-circuit or short-circuit condition. The low scale value is determined by the input type, data format, and scaling selected.
11	not used	

Temperature Units Selection (Bit 8)

The Bit Descriptions for Temperature Units Selection table shows the description for bit 8. The temperature units bit lets you select temperature engineering units in °C or °F for RTD input types. This bit field is only active for RTD input types. It is ignored when the resistance input type is selected.

Bit Descriptions for Temperature Units Selection

Binary Value	Select	If you want to
0	Degrees Celsius	Display the channel data word in degrees Celsius
1	Degrees Fahrenheit	Display the channel data word in degrees Fahrenheit

Filter Frequency Selection (Bits 9 and 10)

The Bit Descriptions for Filter Frequency Selection table shows the descriptions for bits 9 and 10. The channel filter frequency bit field lets you select one of four filters available for a channel. The filter frequency affects the channel update time and noise rejection characteristics (refer to chapter 4 for details).

Bit Descriptions for Filter Frequency Selection

Binary Value	Select	Description
00	10 Hz	Provide both 50 Hz and 60 Hz ac line noise filtering. This setting increases the channel update time, but also increases the noise rejection.
01	50 Hz	Provide 50 Hz ac line noise filtering.
10	60 Hz	Provide 60 Hz ac line noise filtering.
11	250 Hz	Provide 250 Hz ac noise filtering. This setting decreases the noise rejection, but also decreases the channel update time.

Channel Enable Selection (Bit 11)

The Bit Descriptions for Channel Enable Selection table shows the description for bit 11. You use the channel enable bit to enable a channel. The RTD module only scans those channels that are enabled. To optimize module operation and minimize throughput times, you should disable unused channels by setting the channel enable bit to zero.

When set (1), the channel enable bit is used by the module to read the configuration word information you have selected. While the enable bit is set, modification of the configuration word may lengthen the module update time for one cycle. If any change is made to the configuration word, the change must be reflected in the status word before new data is valid.

Refer to Channel Status Checking on page 82.

While the channel enable bit is cleared (0), the channel data word and status word values are cleared. After the channel enable bit is set, the channel data word and status word remain cleared until the RTD module sets the channel status bit (bit 11) in the channel status word.

Bit Descriptions for Channel Enable Selection

Binary Value	Select	Description
0	Channel disable	Disable a channel. Disabling a channel causes the channel data word and the channel status word to be cleared.
1	Channel enable	Enable a channel.

Excitation Current Selection (Bit 12)

The Bit Description for Excitation Current Selection table gives the description for bit 12. Use this bit to select the magnitude of the excitation current for each enabled channel. Choose from either 2.0 mA or 0.5 mA. This bit field is active for all inputs. A lower current reduces the error due to RTD self heating, but provides a lower signal-to-noise ratio. Refer to RTD vendor for recommendations.

See page 119 for general information.

Bit Description for Excitation Current Selection

Binary Value	Select	Description
0	2.0 mA	Set the excitation current to 2.0 mA
1	0.5 mA	Set the excitation current to 0.5 mA

Scaling Select (Bits 13-14)

If you selected proportional counts as the format for your input data, you can enter a scaling range that ensures your data is scaled within a range appropriate for your use. You can use words 4 and 5 to define one range and words 6 and 7 to define a second range. The Bit Descriptions for Scaling Selection table gives the descriptions for bits 13 and 14.

Bit Descriptions for Scaling Selection

Binary Value	Select	If you want to
00	Use module defined scaling	Configure the module to scale the data word using the default scale range (-32,768 to 32,767) for scaled-for-PID and proportional counts.
01	Use configuration words 4 and 5 for scaling (range 0)	Define a range (range 0) that your proportional counts data will be scaled to. Configuration word 4 contains the low scale limit and configuration word 5 contains the high scale limit. If you make this setting, be sure to enter low and high scale values into configuration words 4 and 5.
10	Use configuration words 6 and 7 for scaling (range 1)	Define a range (range 1) that your proportional counts data will be scaled to. Configuration word 6 contains the low scale limit and configuration 7 contains the high scale limit. If you make this setting be sure to enter low and high scale values into configuration words 6 and 7.
11	not used	(configuration error)

Default Scaling

The first case to consider is when default scaling is selected and the scaling select bits (bits 13 and 14) are set to 00 (module defined scaling).

Refer to Scaled-for-PID on page 68 and Proportional Counts Data Format on page 69 for considerations when using default values.

User-set Scaling

Proportional Counts - The second case to consider is User-set Scaling using proportional counts when the scaling select bits 13 and 14 are set to 01 or 10. Here you can configure the module to scale the data word to something other than -32,768 to 32,767. However, the maximum range remains -32,768 to +32,767. You define what the upper and lower limits are going to be by placing the range in the user-set scaling words for range 0 (words 4 and 5) or range 1 (words 6 and 7). The module scales the input data to the upper and lower limit in a linear relationship. The following example clarifies this feature. In this example, the RTD module channel that will be configured for user-set scaling is channel 3.

As shown in User-set Scaling Using Proportional Counts Data Format on page 80, you have programmed the channel 3 configuration word for 1000 Ω potentiometer (bits 0...3): proportional counts data format (bits 4 and 5): and configuration words 4 and 5 for scaling (bits 13 and 14).

The program for the following example is described on page 95 in Chapter 6.

EXAMPLE

You desire to control the line speed of a conveyor. A 1000 Ω potentiometer is used to sense the conveyor line speed. The line speed varies between 3 ft/minute (0 Ω) and 50 ft/minute (1000 Ω).

As shown in User-set Scaling Using Proportional Counts Data Format on page 80, you select a 1000 Ω potentiometer as the input type.

If you choose engineering units as the data format, the module data word is a value between 0...1000 Ω . However, if you choose the proportional counts data format and utilizes the user-set scaling feature, the number 3 can be entered in O:e.4 and the number 50 in O:e.5. In this situation, the RTD module returns a number between 3...50 in its data word. This action saves you time in ladder programming.

Unused (Bit 15)

Bit 15 is not used. Verify that this bit is always cleared (0).

The actual RTD or resistance input sensor values reside in I:e.0 through I:e.3 of the RTD module input image file. The data values present depend on the input type and data format you have selected in your configuration for the channel. When an input channel is disabled, its data word is reset (0).

Channel Data Word

Two conditions must be true for the value of the data word shown in the Module Input Image (Data Word) to be valid.

- The channel must be enabled (channel status bit = 1)
- There must be no channel errors (channel error bit = 0)

Module Input Image (Data Word)

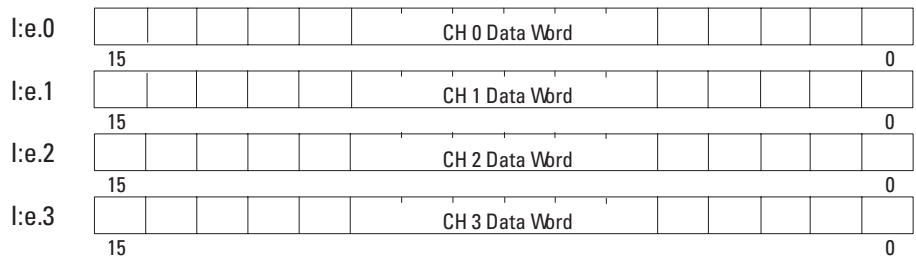

Channel Status Checking

The channel status word is a part of the RTD module's input image. Input words 4...7 correspond to and contain the configuration status of channels 0, 1, 2, and 3 respectively. You can use the data provided in the status word to determine if the data word for any channel is valid per your configuration in O:e.0 through O:e.3.

For example, whenever a channel is disabled (O:e.x/11 = 0), its corresponding status word shows all zeros. This condition tells you that input data contained in the data word for that channel is not valid and should be ignored.

Module Input Image (Status Word)

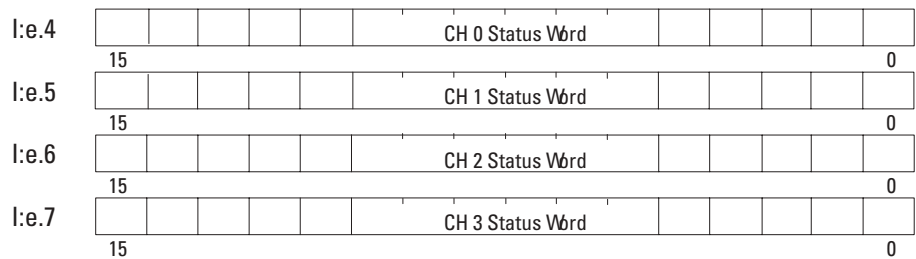

The channel status word can be analyzed bit by bit. Each bit's status (0 or 1) tells you how the input data from the RTD sensor or resistance device connected to a specific channel is translated for your application. The bit status also informs you of any error condition and can tell you what type error occurred.

A bit-by-bit examination of the status word is provided in the Channel 0...3 Status Word (I:e.4 through I:e.7) - Bit Definitions table.

Channel 0...3 Status Word (I:e.4 through I:e.7) - Bit Definitions

Bits	Define	These bit settings																Indicate this		
		15	14	13	12	11	10	9	8	7	6	5	4	3	2	1	0			
0...3	Input type status														0	0	0	0	100 Ω Pt RTD (385)	
																0	0	0	1	200 Ω Pt RTD (385)
																0	0	1	0	500 Ω Pt RTD (385)
																0	0	1	1	1000 Ω Pt RTD (385)
																0	1	0	0	100 Ω Pt RTD (3916)
																0	1	0	1	200 Ω Pt RTD (3916)
																0	1	1	0	500 Ω Pt RTD (3916)
																0	1	1	1	1000 Ω Pt RTD (3916)
																1	0	0	0	10 Ω Cu RTD (426) ⁽¹⁾
																1	0	0	1	120 Ω Ni RTD (618) ⁽²⁾
																1	0	1	0	120 Ω Ni RTD (672)
																1	0	1	1	604 Ω NiFe RTD (518)
																1	1	0	0	150 Ω Resistance Input
																1	1	1	0	1000 Ω Resistance Input
														1	1	1	1	3000 Ω Resistance Input		
4...5	Data format status													0	0				Engineering units X 1 ⁽³⁾	
														0	1				Engineering units X 10 ⁽⁴⁾	
														1	0				Scaled-for-PID	
														1	1				Proportional Counts	
6...7	Broken input status												0	0					Set to Zero	
														0	1				Set to Upscale	
															1	0			Set to Downscale	
															1	1			Not used	
8	Temperature units status												0						Degrees °C ⁽⁵⁾	
														1					Degrees °F ⁽⁵⁾	
9...10	Filter frequency status																		10 Hz	
																			50 Hz	
																			60 Hz	
																			250 Hz	
11	Channel enable status																		Channel Disabled	
																			Channel Enabled	
12	Excitation current status																		2.0 mA	
																			0.5 mA	
13	Broken input error status																		No error	
																			Short or opened detected	
14	Out of range error status																		No error	
																			Out of range detected	
15	Configuration error status																		No error	
																			Configuration error	

(1) Actual value at 0 °C (32 °F) is 9.042 Ω per SAMA standard RC21-4-1966.
 (2) Actual value at 0 °C (32 °F) is 100 Ω per DIN standard.
 (3) Values are in 0.1 degrees/step or 0.1 Ω/step for all resistance input types, except 150 Ω. For the 150 Ω resistance input type, the values are in 0.01 Ω/step.
 (4) Values are in 1 degree /step or 1 Ω/step for all resistance input types, except 150 Ω. For the 150 Ω resistance input type, the values are in 0.1 Ω/step.
 (5) This bit is cleared (0) when a resistance device, such as a potentiometer, is selected.

IMPORTANT

The status bits reflect the settings that were made in the configuration word. However, two conditions must be true if the status reflected is to be accurate.

- The channel must be enabled.
 - The channel must have processed any new configuration data.
-

Input Type Status (Bits 0...3)

The input type bit field indicates what type of input device you have configured for the channel. This field reflects the input type selected in bits 0...3 of the channel configuration word when the channel is enabled. If the channel is disabled, these bits are cleared (0).

Data Format Status (Bits 4 and 5)

The data format bit field indicates the data format you have defined for the channel. This field reflects the data type selected in bits 4 and 5 of the channel configuration word when the channel is enabled. If the channel is disabled, these bits are cleared (0).

Broken Input Status (Bits 6 and 7)

The broken input bit field indicates how you have defined the channel data to respond to an open-circuit or short-circuit condition. This field reflects the broken input type selected in bits 6 and 7 of the channel configuration word when the channel is enabled. If the channel is disabled, these bits are cleared (0).

Temperature Units Status (Bit 8)

The temperature units field indicates the state of the temperature units bit in the configuration word (bit 8). This feature is only active for RTD input types with the channel enabled. This bit is cleared (0) if the channel is disabled or if the input type is a resistance device such as potentiometer.

Channel Filter Frequency (Bits 9 and 10)

The channel filter frequency bit field reflects the filter frequency you selected in bits 9...10 of the configuration word when the channel is enabled. This feature is active for all input types. If the channel is disabled, these bits are cleared (0).

Channel Enable Status (Bit 11)

The channel enable status bit indicates whether the channel is enabled or disabled. This bit is set (1) when the channel enable bit is set in the configuration word (bit 11) and there is valid data in the channel's data word. The channel status bit is cleared (0) if the channel is disabled.

Excitation Current (Bit 12)

This bit indicates the excitation current setting made to bit 12 of the channel's configuration word when the channel is enabled. If the channel is disabled, this bit is cleared (0).

Broken Input Error (Bit 13)

This bit is set (1) whenever an enabled channel detects a broken input condition. A broken input error is declared for reasons that include:

- open-circuit - excitation current is less than 50% of the selected current.
- short-circuit - calculated lead wire compensated RTD resistance is less than 3 Ω

The open-circuit error is active for all RTD and resistance inputs, while the short-circuit error is valid only for RTD inputs. If a broken input is detected, the module sends either zero, upscale, or downscale data to the channel data word for that channel, depending on your channel configuration bits 6 and 7.

A broken input error takes precedence over an out-of-range error states. There will not be an out-of-range error when an open-circuit or short circuit is detected.

This bit is cleared if the channel is disabled or if the channel operation is normal.

Out-of-range Error (Bit 14)

This bit is set (1) whenever a configured channel detects an over-range condition for the input channel data, regardless of input type. This bit is also set (1) whenever the module detects an under-range condition when the input type is an RTD. An out-of-range error is declared for either of the following conditions:

- over-range - The RTD temperature is greater than the maximum allowed (default or user-set) temperature or the resistance input type is greater than the maximum allowed (default or user-set) resistance. When this occurs, the channel data word is set to its maximum value.
- under-range - The RTD temperature is less than the minimum allowed (default or user-set) temperature. When this occurs, the channel data word is set to its minimum value.

IMPORTANT

There is no under-range error for a direct resistance input (default scaling).

This bit is cleared (0) when the:

- channel is disabled.
- channel operation is normal, the out-of-range condition clears.
- broken input error bit (bit 13) is set (1).

Configuration Error (Bit 15)

This bit is set (1) whenever an enabled and configured channel detects that the channel configuration word is not valid. A configuration word is not valid for any of the these reasons.

- Input type is a 10 Ω Copper RTD and the excitation current is set for 0.5 mA, which is not allowed.
- Scaling select bits 13 and 14 are set to 11, which is invalid.
- Broken Input select bits 6 and 7 are set to 11, which is invalid.
- Scaling select bits 13 and 14 are set to 01 or 10 and scaling limit words=0.
- Data format bits are set to 11, the scaling-select bits are set to 01 or 10 and the lower limit user-set scale word is greater than or equal to the upper limit user-set scale word.

All other status bits reflect the settings from the configuration word (even those settings that may be in error). However, bit 15 is cleared if the channel is disabled or if channel operation is normal.

Ladder Programming Examples

Earlier chapters explained how the configuration word defines the way a channel operates. This chapter shows the programming required to enter the configuration word into the processor memory. It also provides you with segments of ladder logic specific to unique situations that might apply to your programming requirements. The example segments include:

- initial programming of the configuration word.
- dynamic programming of the configuration word.
- verifying channel configuration changes.
- interfacing the RTD module to a PID instruction.
- using proportional counts scaling (example).
- monitoring channel status bits.
- invoking autocalibration.

Device Configuration

The Application Setup diagram is used for clarification of the ensuing ladder logic examples and is not intended to represent an RTD application.

IMPORTANT

Chapter 8 shows a typical application for the RTD module.

Application Setup

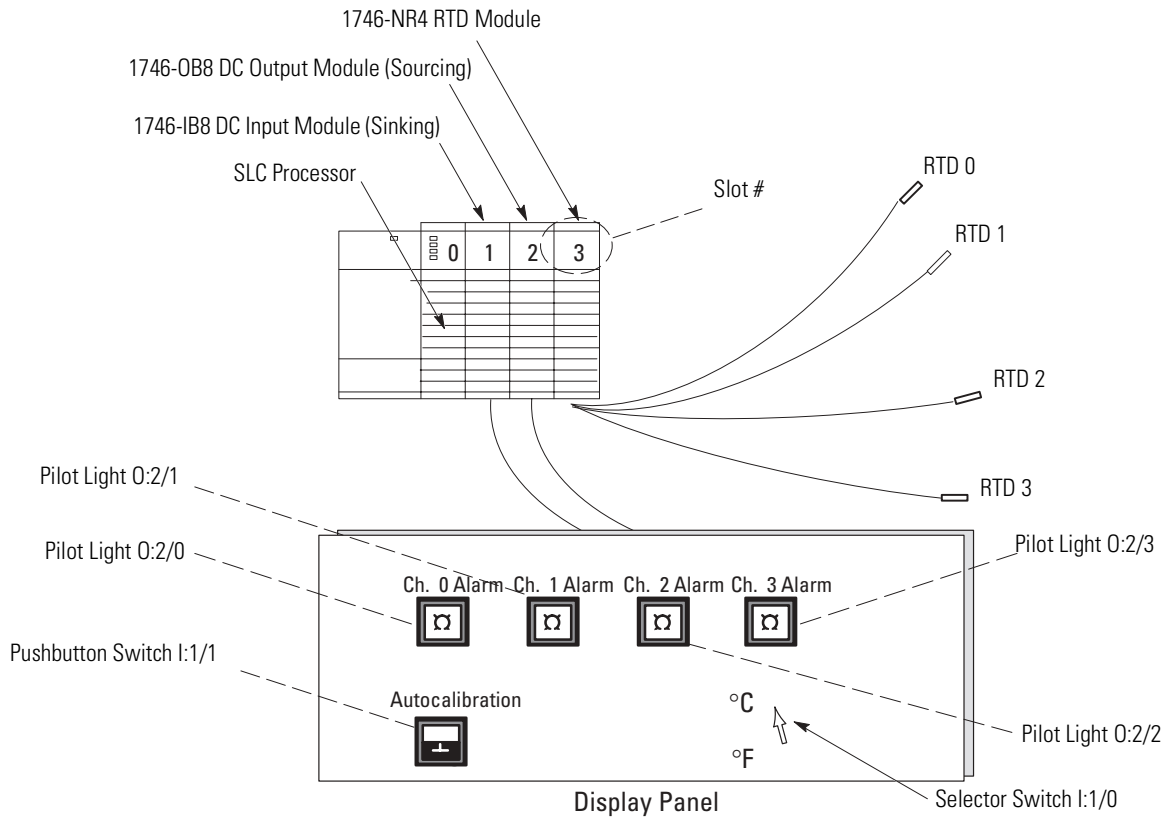

Initial Programming

Follow this example to enter data into the channel configuration word (O:e.0 through O:e.3) when the channel is disabled (bit 11 = 0).

Refer to the Channel Configuration Word (O:e.0 through O:e.3) - Bit Definitions table for specific configuration details.

EXAMPLE

As shown in the Configuration Word Setup diagram, configure four channels of a RTD module residing in slot 3 of a 1746 chassis. Configure each channel with the same parameters.

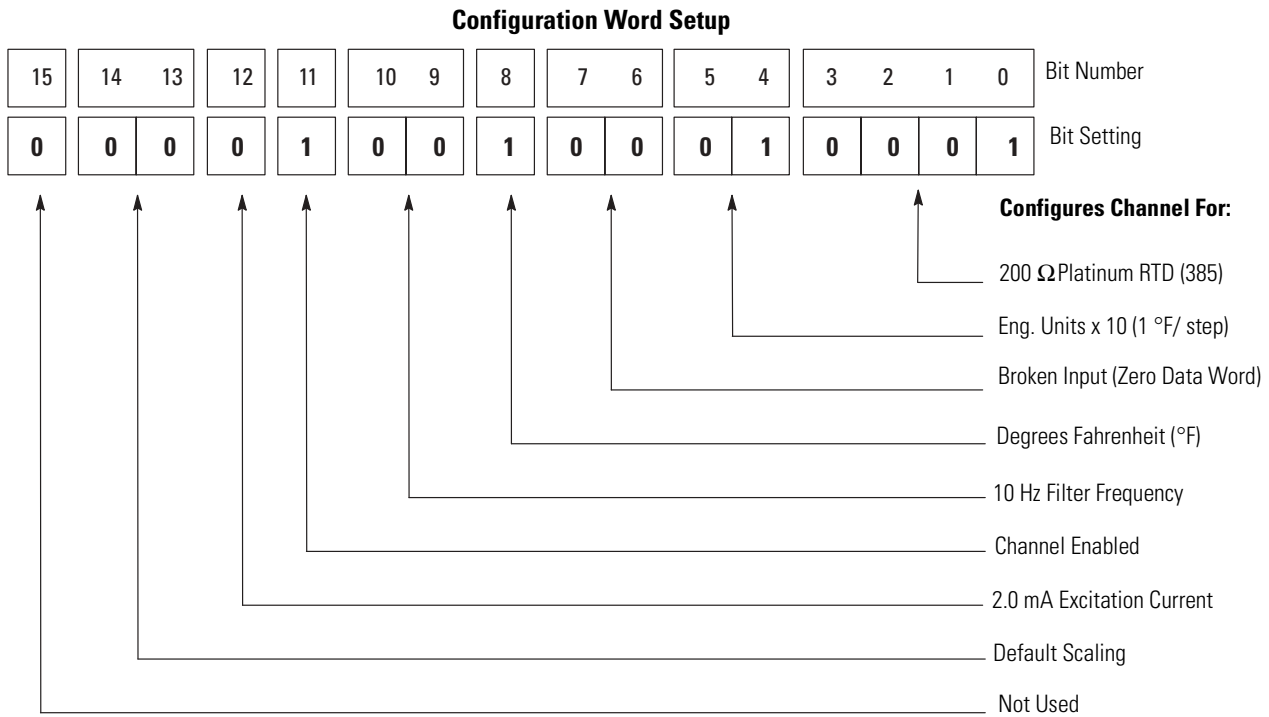

This example transfers configuration data and sets the channel enable bits of all four channels with a single file copy instruction. The file copy instruction copies four data words from an integer file you create in the SLC controller's memory, to the RTD module's channel configuration words.

Copy File Data Flow

ADDRESS	SOURCE DATA FILE	ADDRESS	DESTINATION DATA FILE
N10:0	Channel Configuration Word 0	→ 0:3.0	Channel Output Word 0
N10:1	Channel Configuration Word 1	→ 0:3.1	Channel Output Word 1
N10:2	Channel Configuration Word 2	→ 0:3.2	Channel Output Word 2
N10:3	Channel Configuration Word 3	→ 0:3.3	Channel Output Word 3

Programming Procedure

1. Create integer file N10 in your programming software.

Integer file N10 should contain four elements (N10:0 through N10:3).

2. Enter the configuration parameters for all four RTD channels into a source integer data file N10.

Refer to the Configuration Word Setup for the bit values.

See page 128 for a channel configuration worksheet.

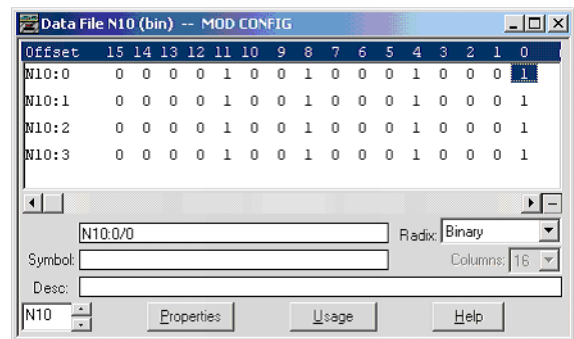

3. Program this rung to use the copy file instruction (COP) to copy the contents of integer file N10 to the four consecutive output words of the RTD module beginning with O:3.0.

All elements are copied from the specified source file to the destination during the first scan after applying power to the module.

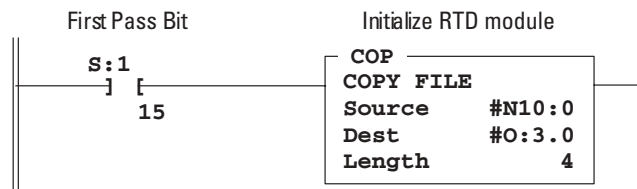

Dynamic Programming

The programming example explains how to change data in the channel configuration word when the channel is currently enabled.

EXAMPLE

Execute a dynamic configuration change to channel 2 of the RTD module located in slot 3 of a 1746 chassis. Change from monitoring the temperature in °F to monitoring in °C.

Programming Procedure

1. Create a new element in integer file N10 using the memory map function.

Integer file N10 already contains four elements (N10:0 through N10:3). You add a fifth element (N10:4).

2. Enter the same configuration data as in the previous example using the data monitor function, except for bit 8.

Bit 8 is now set for a logic 0 (°C).

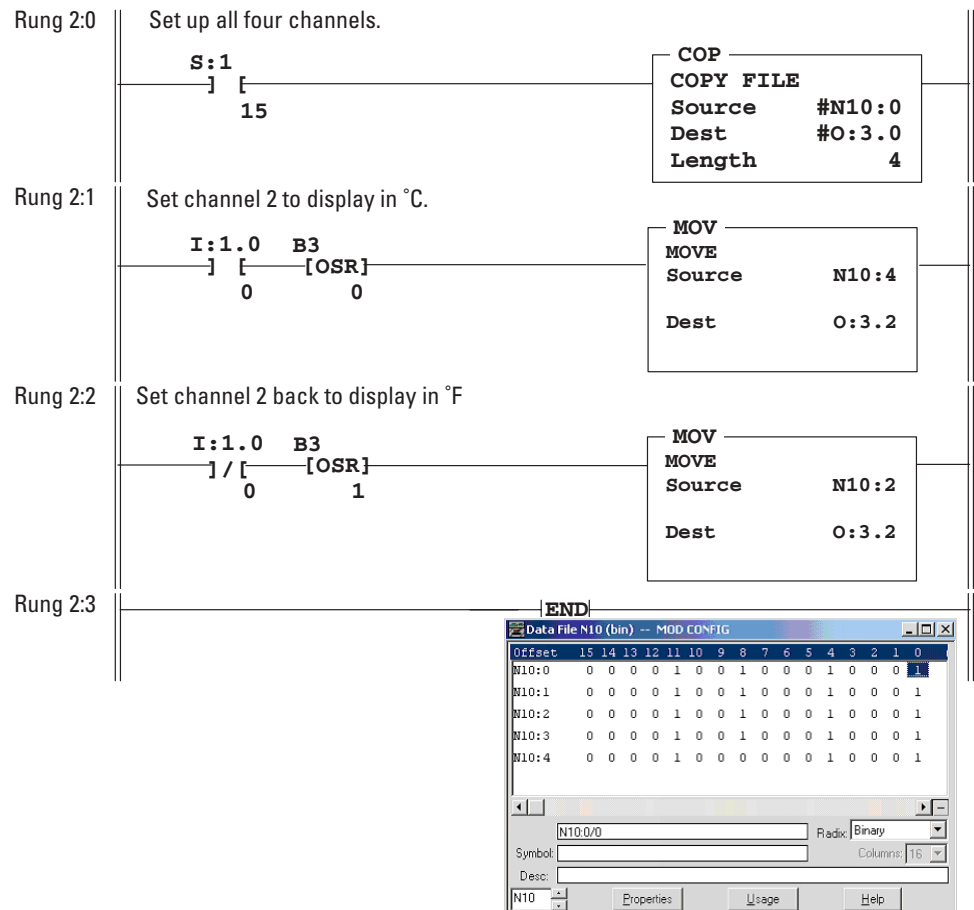

Verify Channel Configuration Changes

When executing a dynamic channel configuration change, there is always a delay from the time the ladder program makes the change to the time the RTD module gives you a data word using that new configuration information. Therefore, it is very important to verify that a dynamic channel configuration change took effect in the RTD module. This is particularly important if the channel being dynamically configured is used for control. The Program to Verify Configuration Word Data Changes ladder diagram explains how to verify that channel configuration changes have taken effect.

EXAMPLE

Execute a dynamic configuration change to channel 2 of the RTD module located in slot 3 of a 1746 chassis, and set an internal data valid bit when the new configuration has taken effect.

Program to Verify Configuration Word Data Changes

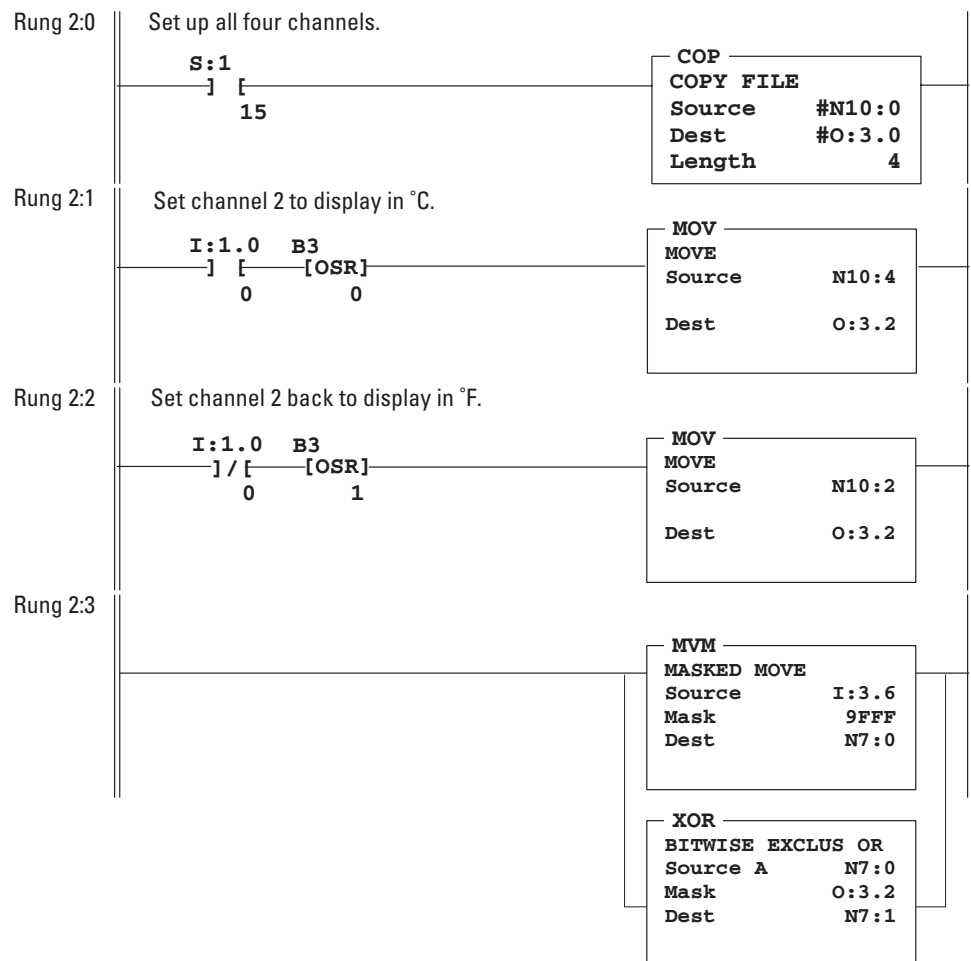

Program to Verify Configuration Word Data Changes - Continued

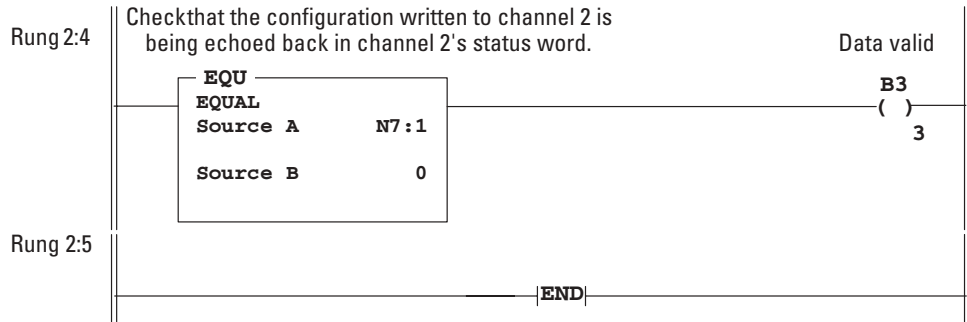

Offset	15	14	13	12	11	10	9	8	7	6	5	4	3	2	1	0
N10:0	0	0	0	0	1	0	0	1	0	0	0	1	0	0	0	0
N10:1	0	0	0	0	1	0	0	1	0	0	0	1	0	0	0	1
N10:2	0	0	0	0	1	0	0	1	0	0	0	1	0	0	0	1
N10:3	0	0	0	0	1	0	0	1	0	0	0	1	0	0	0	1
N10:4	0	0	0	0	1	0	0	0	0	0	0	1	0	0	0	1

Interface to the PID Instruction

The RTD module was designed to interface directly to the SLC 5/02, SLC 5/03, SLC 5/04, and SLC 5/05 PID instruction without the need for an intermediate scale operation. Use RTD channel data as the process variable in the PID instruction.

Use this procedure to program this application.

1. Select 100 Ω Platinum RTD, $\alpha = 0.003916$, as the input type by setting bit 0 = 0, bit 1 = 0, bit 2 = 1, and bit 3 = 0 in the configuration word.
2. Select scaled-for-PID as the data type by setting bit 4 = 0 and bit 5 = 1 in the configuration word.

ATTENTION



When using the module's scaled-for-PID data format with the SLC PID function, verify that the PID instruction parameters Maximum Scaled S_{max} (word 8) and Minimum Scaled S_{min} (word 8) match the module's minimum and maximum scaled range in engineering units, (-200...850 $^{\circ}C$, (-328...1562 $^{\circ}F$) for that channel. This allows you to accurately enter the setpoint in engineering units ($^{\circ}C$, $^{\circ}F$).

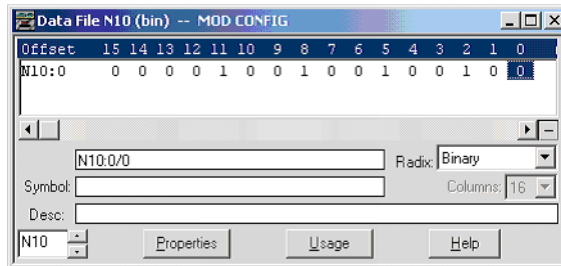
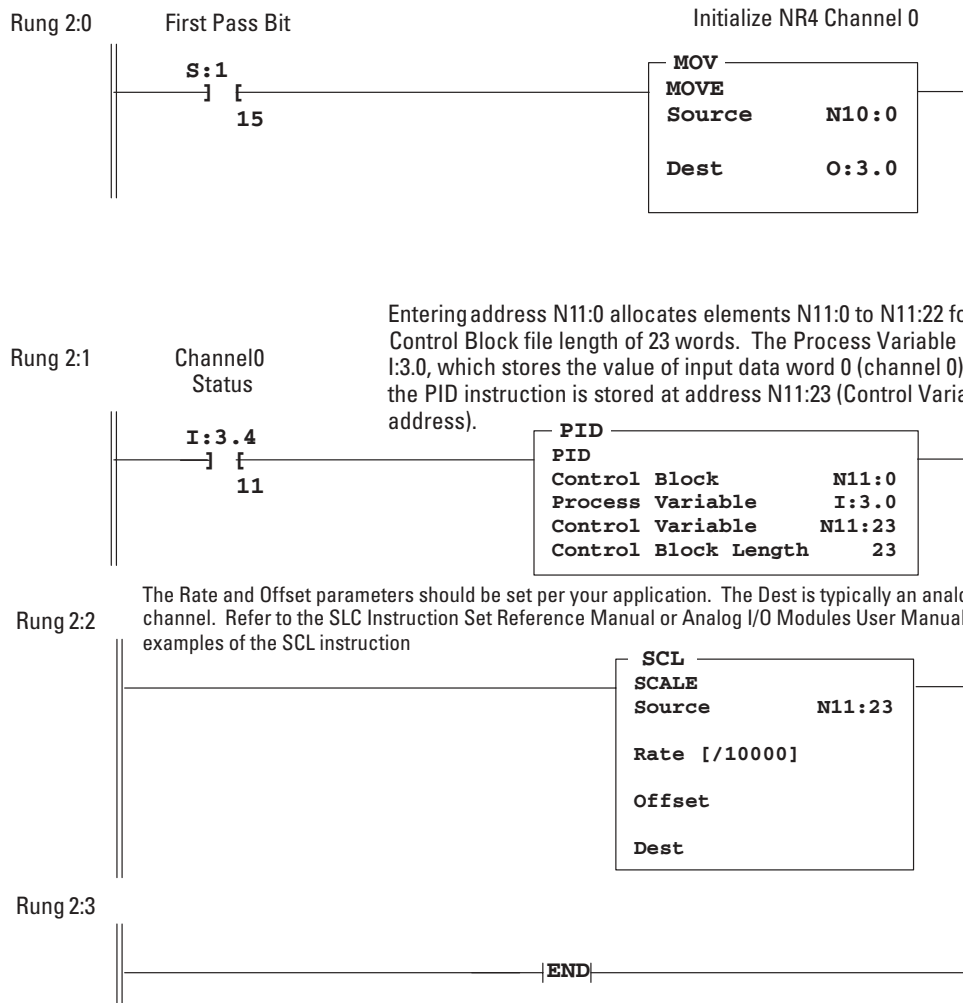

Use the Proportional Counts Data Format with User-set Scaling

The RTD module can be set up to return data to the user program that is specific to the application. Assume that you control the line speed of a conveyor using a 1000 Ω potentiometer connected to channel 0 of the RTD module. The line speed will vary between 3 ft/m when the potentiometer is at 0 Ω and 50 ft/m when the potentiometer is at 1000 Ω .

Follow these procedures to configure the RTD module to return a value between 3...50 in the data word for channel 0.

1. Set bits 0...3 of configuration word 0...1110 to select the 1000 Ω potentiometer input type.
2. Set bits 4 and 5 of configuration word 0...11 to select proportional counts data format.
3. Set bits 13 and 14 of configuration word 0...01 to select range 0 as the scaling range.
4. Enter 3 as the low range into N10:4.
5. Enter 50 as the high range into N10:5.

Six elements are copied from the specified source address (N10:0) to the specified output (O:30:0). Each element is a 16-bit integer as shown in the data table at the bottom of the page.

The Source of this instruction is the data word from the RTD module, which is a number between 3...50. The Dest in this application is an analog output channel controlling the speed of the conveyor motor drive. The Rate and Offset parameters should be set per your application. Refer to the SLC 500 Instruction Set Reference Manual, publication 1747-RM001, or the Analog I/O User Manual, publication 1746-UM005, for specific examples of the SCL instruction.

Rung 2:0

Rung 2:1

Rung 2:2

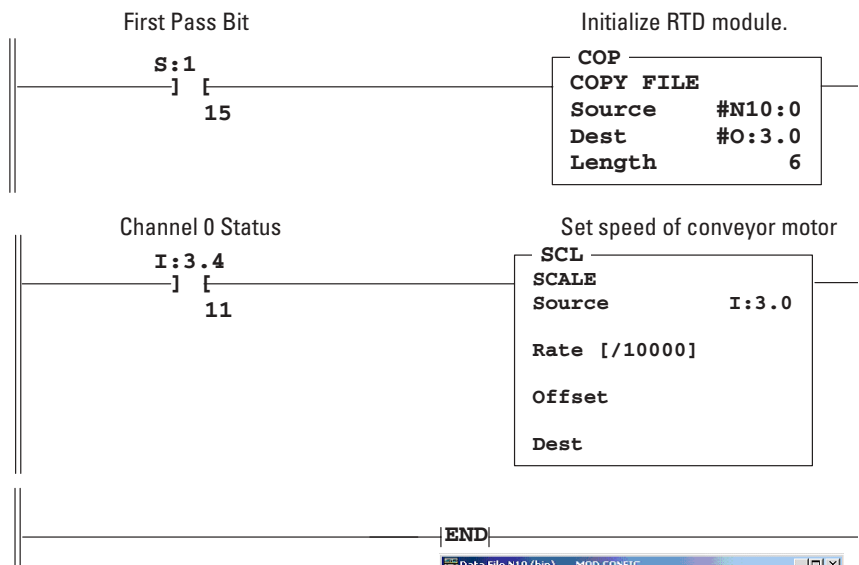

Offset	15	14	13	12	11	10	9	8	7	6	5	4	3	2	1	0
N10:0	0	0	1	0	1	0	0	1	0	0	1	1	1	1	1	0
N10:1	0	0	0	0	0	0	0	0	0	0	0	0	0	0	0	0
N10:2	0	0	0	0	0	0	0	0	0	0	0	0	0	0	0	0
N10:3	0	0	0	0	0	0	0	0	0	0	0	0	0	0	0	0
N10:4	0	0	0	0	0	0	0	0	0	0	0	0	0	0	0	1
N10:5	0	0	0	0	0	0	0	0	0	0	0	1	1	0	0	1

Monitor Channel Status Bits

The Programming to Monitor Channel Status ladder diagram shows how you could monitor the open- and short-circuit error bits of each channel and set an alarm in the processor if one of the RTDs or resistance-input devices (such as a potentiometer) opens or shorts. An open-circuit error can occur if the RTD or resistance-input device breaks or one of the RTD or resistance-input device wires get cut or disconnected from the terminal block. A short-circuit condition applies only to RTD input.

Programming to Monitor Channel Status

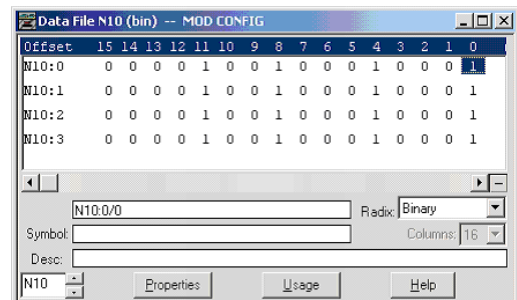
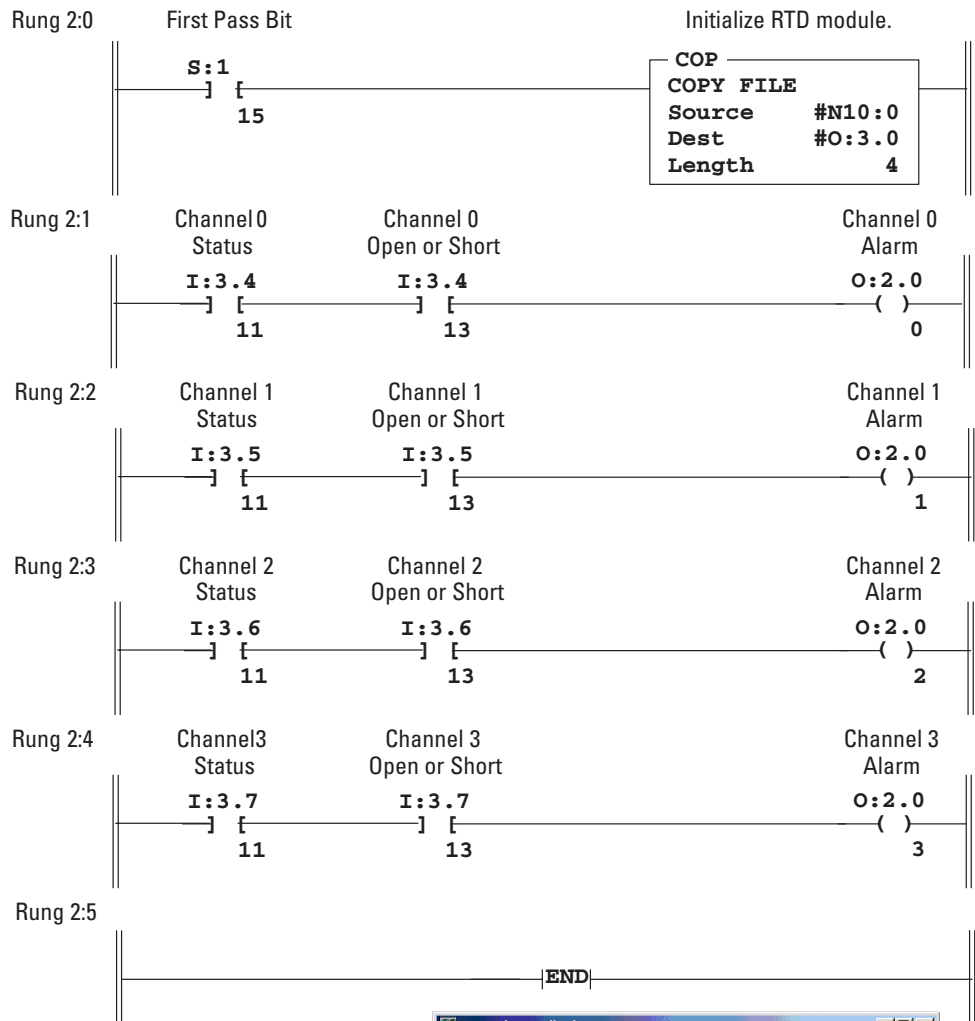

Invoke Autocalibration

Autocalibration of a channel occurs whenever:

- a channel first becomes enabled.
- when a change is made to its input type, filter frequency, or excitation current.
- whenever an operating channel is disabled and re-enabled using its enable bit.

Referring to Programming to Monitor Channel Status on page 96, you can command your module to perform an autocalibration cycle by disabling a channel, waiting for the status bit to change state (1...0), and then re-enabling that channel.

TIP

To maintain system accuracy we recommend that you periodically perform an autocalibration cycle at these times.

- Whenever an event occurs that greatly changes the internal temperature of the control cabinet, such as opening or closing its door
- At a convenient time when the system is not making product, such as during a shift change.

ATTENTION



Several channel cycles are required to perform an autocalibration and it is important to remember that during autocalibration the module is not converting input data.

This ladder diagram show you how to command the RTD module to perform an autocalibration of channel 0. The RTD module is in slot 3.

Programming to Invoke Autocalibration

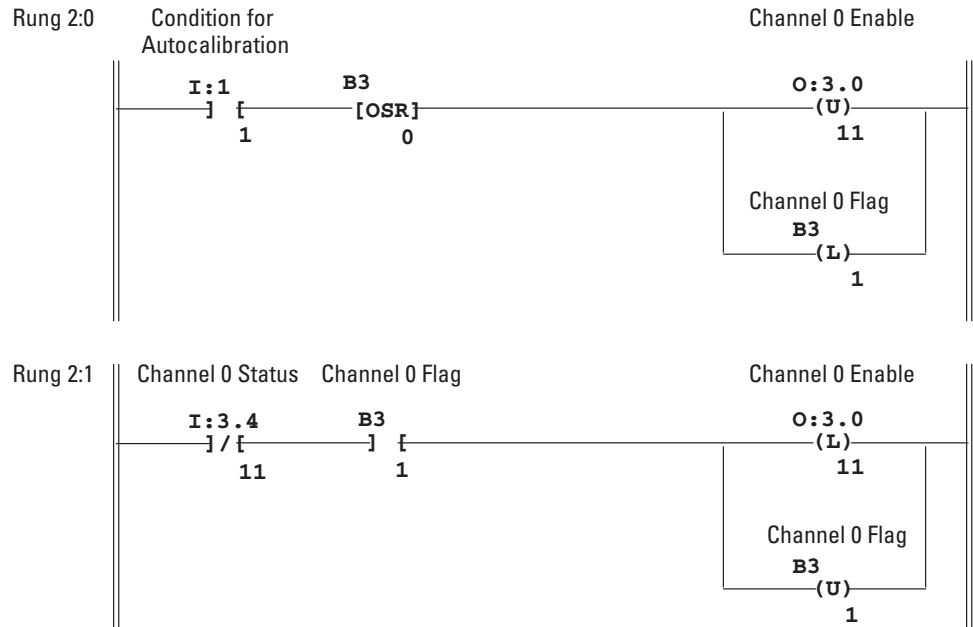

IMPORTANT

The RTD module responds to processor commands much more frequently than it updates its own LED indicators. Therefore, it is normal to execute these two rungs and have the RTD module perform an autocalibration of channel 0 without the channel 0 LED indicator ever changing state.

Module Diagnostics and Troubleshooting

Introduction

This chapter describes troubleshooting using the channel status LED indicators as well as the module status LED indicator.

A troubleshooting flowchart is shown on page 105.

The flowchart explains the types of conditions that might cause an error to be reported and gives suggestions on how to resolve the problem. Major topics include the following:

- Module operation vs. channel operation
- Power-up diagnostics
- Channel diagnostics
- LED indicators
- Troubleshooting flowchart
- Replacement parts
- Contacting Rockwell Automation

Module Operation vs. Channel Operation

The RTD module performs operations at two levels.

- Module-level operations
- Channel-level operations

Module-level operations include functions such as power up configuration and communication with the SLC processor.

Channel-level operations describe channel-related functions, such as data conversion and open-circuit or short-circuit (RTD units only) detection.

Internal diagnostics are performed at both levels of operation and any error conditions detected are immediately indicated by the module's LED indicators and status to the SLC processor.

A series of internal diagnostic self-tests is performed when power is applied to the module. The module status LED indicator and all channel status LED indicators remain off while power is applied. If any diagnostic test fails, the module enters the module error state. If all tests pass, the module status LED indicator is turned on and the channel status LED indicator is turned on for the respective enabled channel. The module continuously scans all enabled channels and communicates with the SLC processor. During power up, the RTD module does not communicate with the processor.

Power Turn-on Diagnostics

When a channel is enabled (bit 11 = 1), a diagnostic check is performed to see that the channel has been properly configured. In addition, the channel is tested for out-of-range, open-circuit, and short circuit faults on every scan.

Channel Diagnostics

A failure of any channel diagnostic test causes the faulted channel status LED indicator to blink. All channel faults are indicated in bits 13...15 of the channel's status word. Channel faults are self-clearing (bits 13 and 14 of status word). Bit 15 is not cleared until the you make the correct change to the channel configuration. The channel LED indicator stops blinking and resumes steady illumination when the fault conditions are corrected.

IMPORTANT

If you clear (0) a channel enable bit (11), all channel status information (including error information) is reset (0).

LED Indicators

The RTD module has five LED indicators. Four of these are channel status LED indicators numbered to correspond to each of the RTD/resistance input channels, and one is a module status LED indicator.

LED Indicator Display

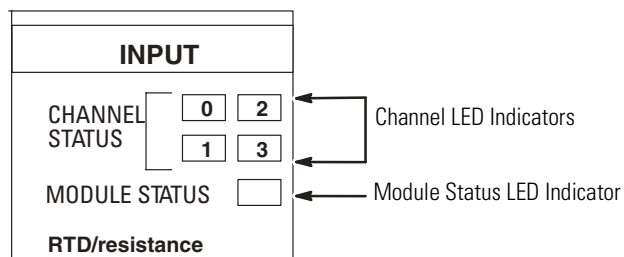

The LED Indicator Status Description table explains the function of the channel status LED indicators while the module status LED indicator is turned on.

LED Indicator Status Description

If Module Status LED Indicator is	And Channel Status LED Indicator is	Indicated Condition	Corrective Action
On	On	Channel enabled	No action required.
	Flashing	Broken Input Condition (open circuit for RTD or resistance input, and short circuit for RTD inputs only)	To determine the exact error, check the error bits 13...15 in the input image. Check the channel configuration word for valid data. Make sure that the input type is indicated correctly in bits 0...3. Refer to the troubleshooting flowchart on page 7-6 and chapter 5 for more information.
		Out-of-range Condition	
		Channel Configuration Error	
	Off	Power-Up	No action required.
Channel Not Enabled		No action required. For an example of how to enable a channel refer to chapter 6, Ladder Programming Examples.	

The Module Status LED Indicator State table explains the function of the module status LED indicator.

Module Status LED Indicator State

If Module Status LED Indicator is	Indicated Condition	Corrective Action
On	Proper Operation	No action required.
Off	Module Fault	Cycle power. If condition persists, replace the model or call your local distributor or Allen-Bradley for assistance.

I/O error codes are reported in word S:6 of the SLC processor status file. The characters denoted as XX represent the slot number (Hex) for the module. The characters denoted as YY represent the 2-digit hex code for the fault condition.

The format for the error codes in the status word (S:6) is shown in the Error Code Format diagram on page 102.

Error Codes

The error codes applicable to the RTD module range from 50H to 5AH. These are non-recoverable errors. For a description of the error codes, refer to SLC 500 Instruction Set Reference Manual (Publication 1747–RM001).

Error Code Format

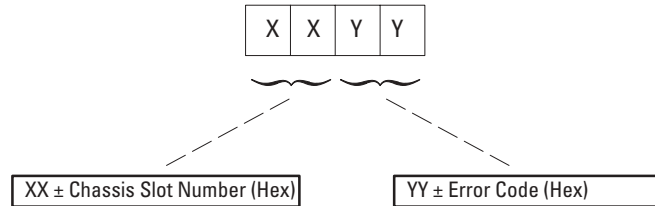

Channel Status LED Indicators (Green)

The channel LED indicator is used to indicate channel status and related error information contained in the channel status word. This includes conditions such as the following:

- Normal operation
- Channel-related configuration errors
- Broken input circuit errors such as open- or short-circuit (RTD units only)
- Out-of-range errors

All channel errors are recoverable errors and after corrective action, normal operation resumes.

Invalid Channel Configuration

Whenever a channel's configuration word is improperly defined, the channel LED indicator blinks and bit 15 of the channel status word is set. Configuration errors occur for the following invalid combinations.

- Input type is a 10 Ω Copper RTD and the excitation current is set for 0.5 mA, which is not allowed
- Scaling select bits 13 and 14 are set to 11, which is invalid
- Broken Input select bits 6 and 7 are set to 11, which is invalid
- Scaling select bits 13 and 14 are set to 01 or 10 and scaling limit words=0
- Data format bits are set to 11 (proportional counts), the scaling-select bits are set to 01 or 10 and the lower limit user-set scale word is greater than or equal to the upper limit user-set scale word

Open- and Short-circuit Detection

An open- or short-circuit test is performed on all enabled channels on each scan. Whenever an open-circuit or short-circuit condition occurs, the channel LED indicator blinks and bit 13 of the channel status word is set.

These are possible causes of an open or short circuit.

- The RTD or potentiometer may be broken.
- A RTD or potentiometer wire may be loose or cut.
- The RTD or potentiometer may not have been installed on the configured channel.
- The RTD may be internally shorted.
- The RTD may be installed incorrectly.

If an open or short-circuit is detected, the channel data word reflects input data as defined by the broken input configuration bits (6 and 7) in the channel configuration word.

Out-of-range Detection

Whenever the data received at the channel data word is out of the defined operating range, an over range or under range error is indicated and bit 14 of the channel status word is set.

IMPORTANT

There is no under range error for a direct resistance input (default scaling).

For a review of the temperature range or resistance range limitations for your input device, refer to the temperature ranges provided in the tables on page 72...73 or the user-specified range in configuration words 4...7 if proportional counts is used.

Possible causes of an out-of-range condition include the following:

- The temperature is too hot or too cold for the RTD unit being used.
- Wrong RTD unit used for type/configuration selected.
- Bad potentiometer or RTD unit.
- Signal input from either potentiometer or RTD unit is beyond the user-set scaling range.

Module Status LED Indicator (Green)

The module status LED indicator is used to indicate module-related diagnostic or operating errors. These non-recoverable errors may be detected when you apply power or during module operation. Once in a module error state, the RTD module no longer communicates with the SLC processor. Channels are disabled and data words are cleared (0).

Failure of any diagnostic test places the module in a non-recoverable state. To exit this state, cycle power. If the power cycle does not work, then call your local distributor or Rockwell Automation for assistance.

Troubleshooting Flowchart

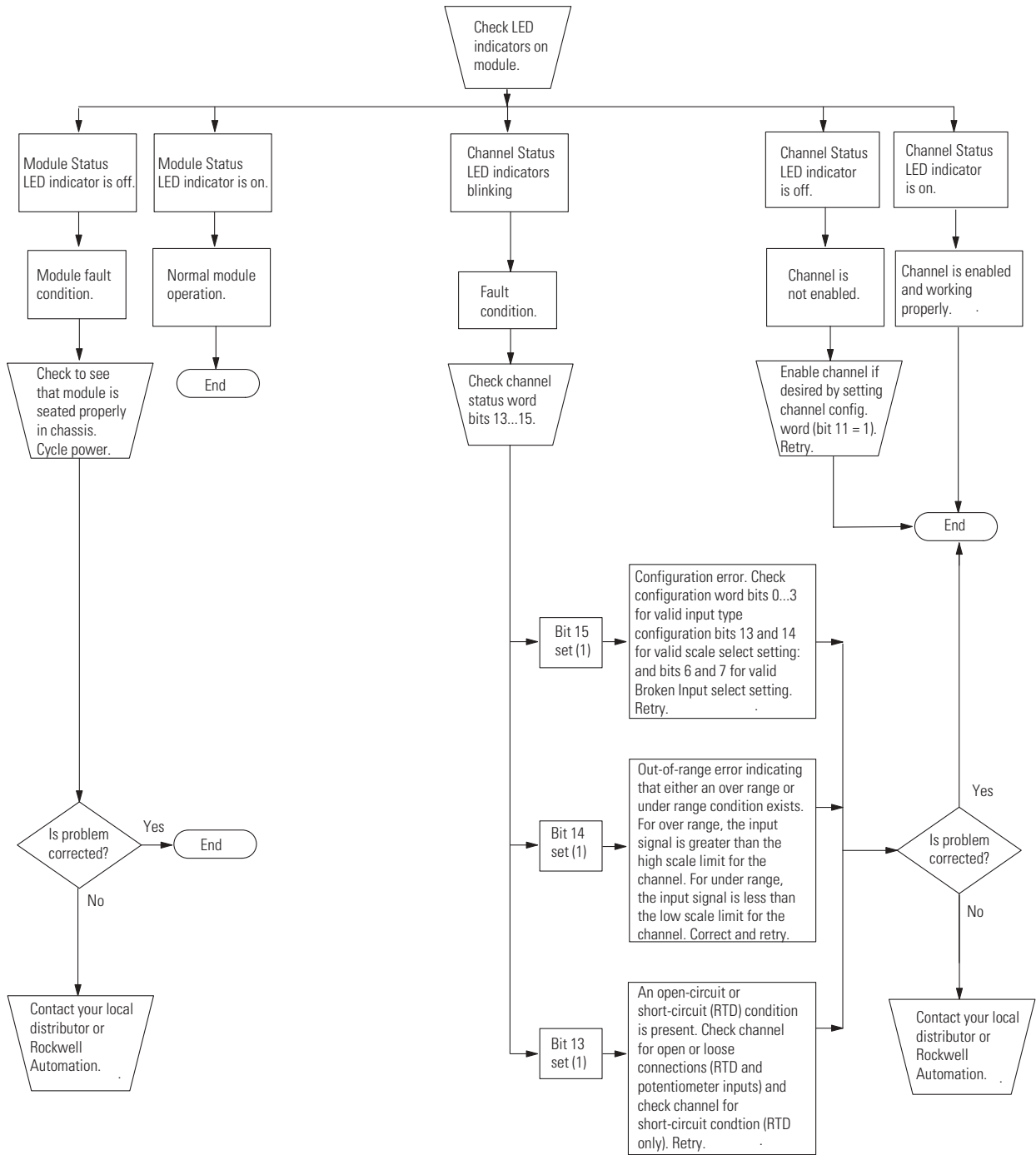

Replacement Parts

The RTD module has the following replaceable parts.

Parts List

Part	Part Number
Replacement Terminal Block	1746-RT25G
Replacement Terminal Cover	1746-R13 series G
1746-NR4 User Manual	1746-6.7

Contact Rockwell Automation

If you need to contact Rockwell Automation for assistance, please have the following information available when you call.

- A clear statement of the problem including a description of what the system is actually doing. Note and record the LED indicator states; also, note input and output image words for the RTD module.
- A list of things you have already tried to remedy the problem.
- Processor type, 1746-NR4 series letter, and firmware (FRN) number. See label on left side of processor.
- Hardware types in the system including I/O modules and chassis.
- Fault code if the SLC processor is faulted.

Application Examples

This chapter provides two application examples to help you use the RTD input module. They are defined as a:

- basic example.
- supplementary example.

The basic example builds on the configuration word programming provided in chapter 6 to set up one channel for operation.

This setup is then used in a typical application to display temperature.

The supplementary example demonstrates how to perform a dynamic configuration of all four channels. The example sets up an application that allows you to manually select whether the displayed RTD input data for any channel is expressed in °C or °F.

Use the Channel Configuration Worksheet (With Settings Established for Channel 0).

Basic Example

The Device Configuration diagram indicates the temperature of a bath on an LED display. The display requires binary coded decimal (BCD) data, so the program must convert the temperature reading from the RTD module to BCD before sending it to the display. This application displays the temperature in °F.

Device Configuration

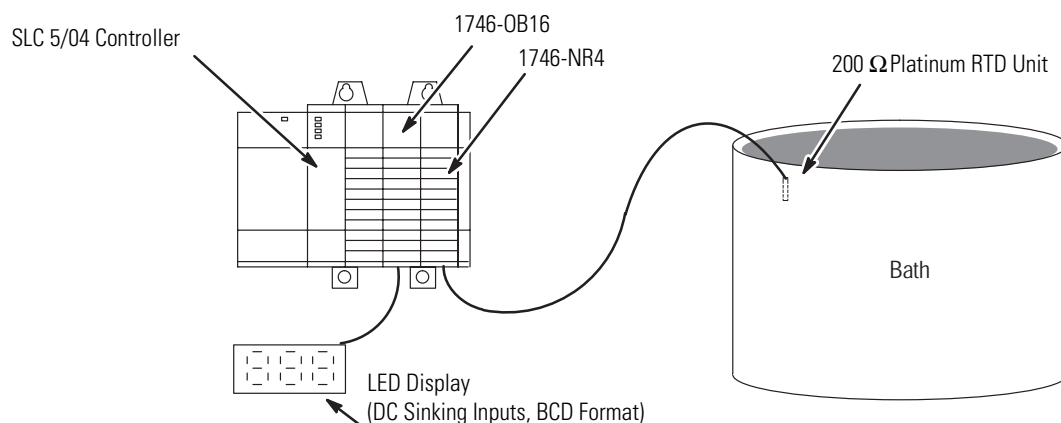

Channel Configuration

Configure the RTD channel with the following setup:

- 200 Ω Platinum RTD
- °F in whole degrees
- Zero data word in the event of an open or short circuit
- 10 Hz input filter
- 2.0 mA excitation current

Channel Configuration Worksheet (With Settings Established for Channel 0)

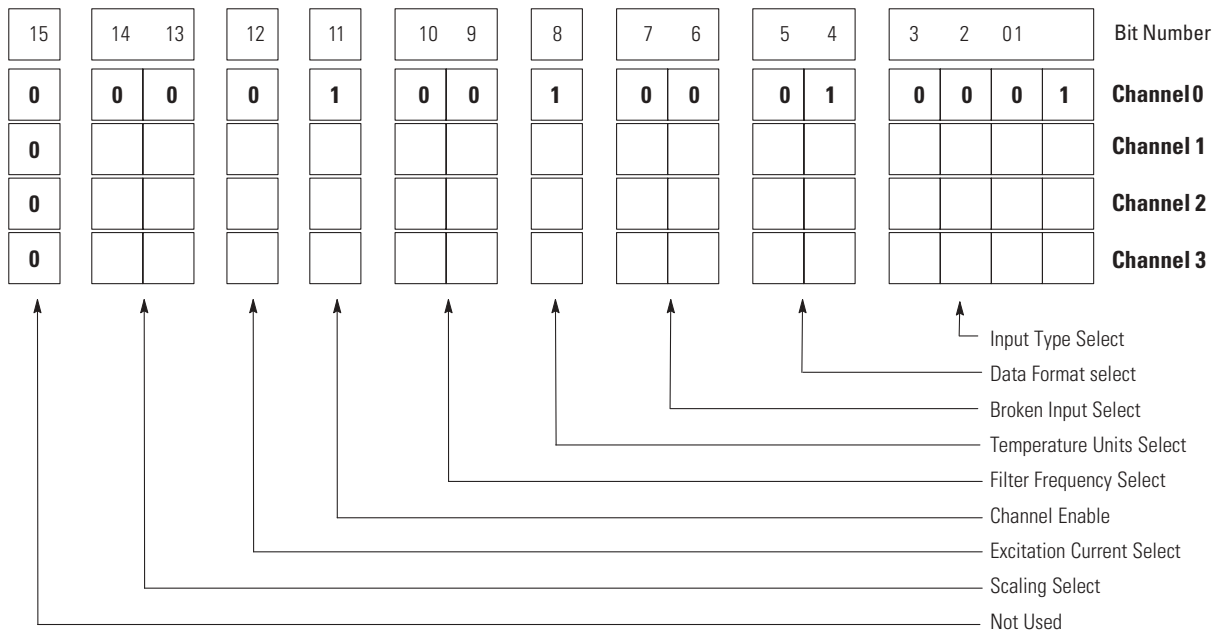

Bits 0...3	Input Type Selected	0000 = 100 Ω Pt. (385) 0001 = 200 Ω Pt. (385) 0010 = 500 Ω Pt. (385) 0011 = 1000 Ω Pt. (385) 0100 = 100 Ω Pt. (3916) 0101 = 200 Ω Pt. (3916)	0110 = 500 Ω Pt. (3916) 0111 = 1000 Ω Pt. (3916) 1000 = 10 Ω Cu (426) ⁽¹⁾ 1001 = 120 Ω Ni (618) ⁽²⁾ 1010 = 120 Ω Ni (672) 1011 = 604 Ω Ni-Fe (518)	1100 = 150 Ω Potentiometer 1001 = 500 Ω Potentiometer 1110 = 1000 Ω Potentiometer 1111 = 3000 Ω Potentiometer	
Bits 4 and 5	Data Format Select	00 = engineering units, x 1 ⁽³⁾ 01 = engineering units, x10 ⁽⁴⁾		10 = scaled-for-PID (0...16,383) 11 = proportional counts (-32,768 ...32,767)	
Bits 6 and 7	Broken Input Select	00 = zero	01 = upscale	10 = downscale	11 = invalid
Bits 8	Temperature Units Select	0 = degrees Celsius	1 = ° F		
Bits 9 and 10	Filter Frequency Select	00 = 10 Hz	01 = 50 Hz	10 = 60 Hz	11 = invalid
Bit 11	Channel Enable	0 = channel disabled	1 = channel enabled		
Bit 12	Excitation Current Select	0 = 2.0 mA	1 = 0.5 mA		
Bit 13 and 14	Scaling Select	00 = module defined scaling (default)	01 = config. words 4 and 5 for scaling	10 = config words 6 and 7 for scaling	11 = Not used (config error)
Bits 15	Not Used	0 = always make this setting			

⁽¹⁾ Actual value at 0 °C (32 °F) is 9.042 Ω per SAMA standard RC21-4-1966.

⁽²⁾ Actual value at 0 °C (32 °F) is 100 Ω per DIN standard.

⁽³⁾ Values are 0.1 °/step or 0.1 Ω /step for all resistance input types except 150 Ω . For the 150 Ω resistance input type, the values are in 0.01 Ω /step.

⁽⁴⁾ Values are 1 °/step or 1 Ω /step for all resistance input types except 150 Ω . For the 150 Ω resistance input type, the values are in 0.1 Ω /step.

Program Listing

Because a seven-segment LED indicator display is used to display temperature, the temperature data must be converted to BCD. The 16-bit data word representing the temperature value is converted into BCD values by the program shown in the Program to Convert °F to BCD.

Program to Convert °F to BCD

Rung 2.0

First Pass Bit

Initialize Channel 0 of RTD Module.



Rung 2.1

Convert the channel 0 data word (degrees F) to BCD values and write this to the LED display. If channel 0 is ever disabled, a zero is written to the display

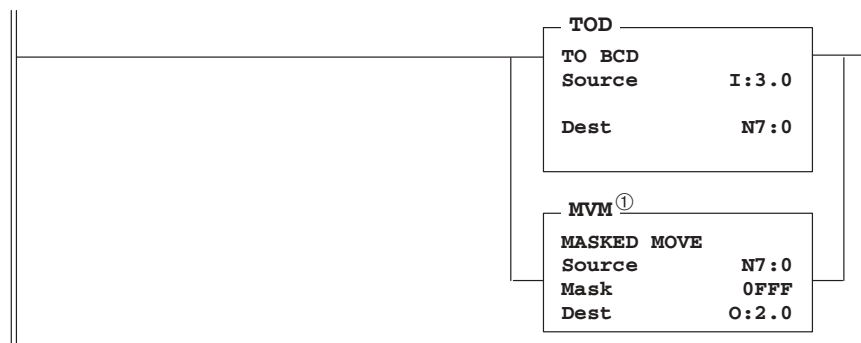

① The use of the masked move instruction with the OFFF mask allows you to use outputs 12, 13, 14, and 15 for other output devices in your system. The 7-segment display uses outputs 0-11.

Rung 2.2

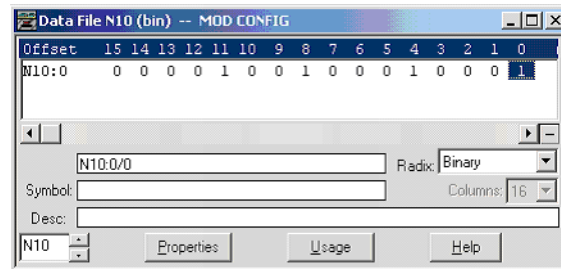
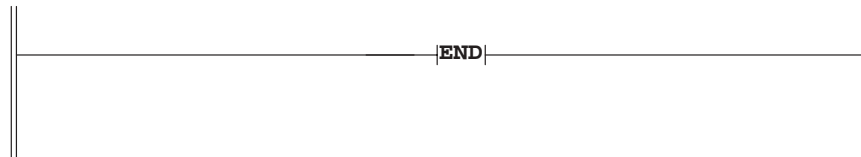

Supplementary Example

This example provides the application setup, channel configuration, and program setup.

Application Setup (Four Channels °C ↔ °F)

Device Configuration for Displaying Many RTD Outputs shows how to display the temperature of several different RTD units at one annunciator panel. A selector switch (I:2/0) allows the operator to choose between displaying data in °C and °F. Each of the displays is a 4-digit, 7-segment LED display with the last digit representing tenths of a degree. The displays have dc-sinking inputs and use a BCD data format.

Device Configuration for Displaying Many RTD Outputs

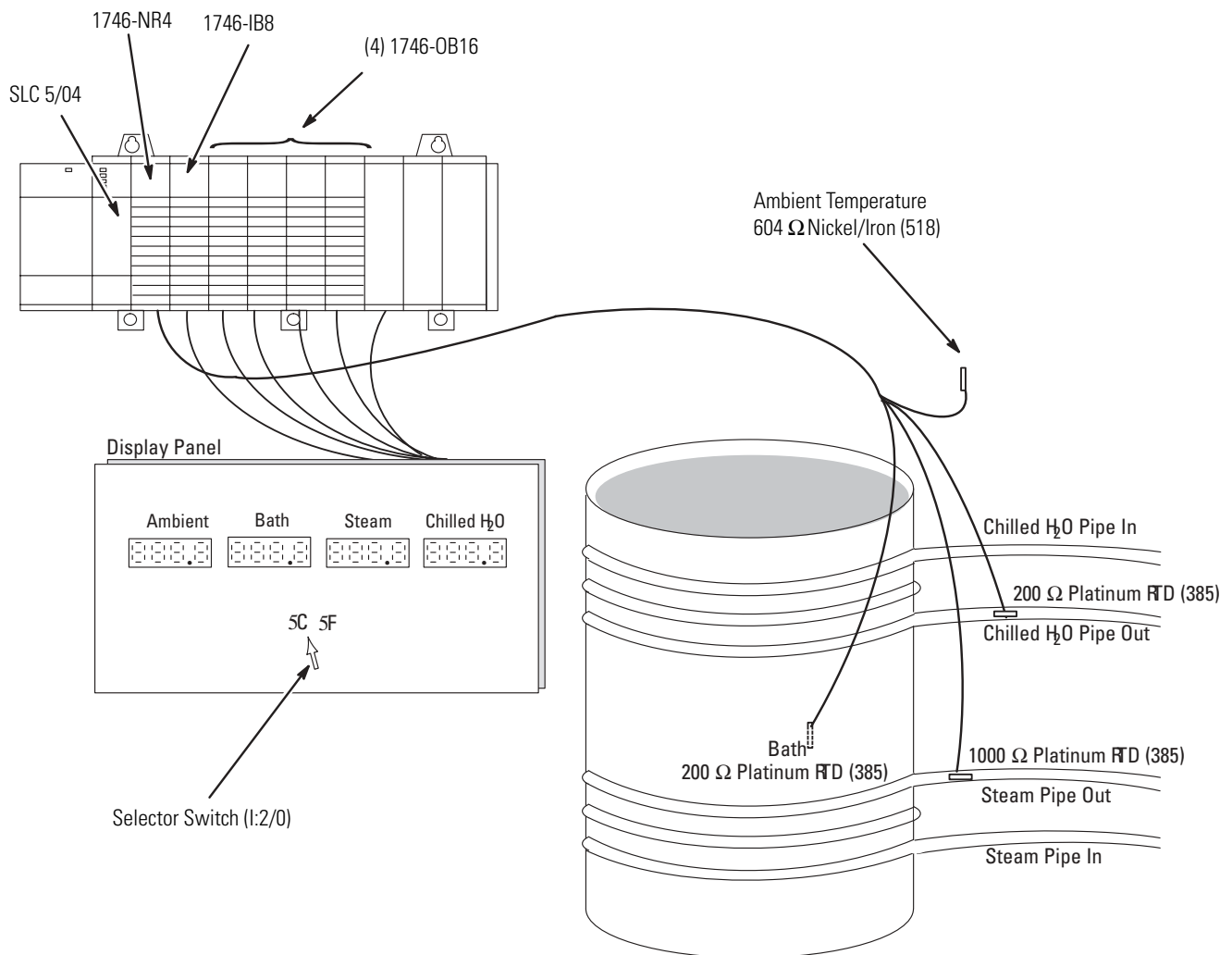

Channel Configuration

See completed worksheet in Channel Configuration Worksheet (With Settings Established) on page 113.

Configuration setup for ambient RTD includes the following:

- channel 0
- 604 Ω Nickel/Iron (518)
- display temperature to tenths of a degree Celsius
- zero data word in the event of an open or short circuit
- 60 Hz input filter to provide 60 Hz line noise rejection
- use 2.0 mA excitation current for RTD
- select module defined scaling

Configuration setup for bath RTD includes the following:

- channel 1
- 200 Ω Platinum RTD (385)
- display temperature to tenths of a degree Celsius
- zero data word in the event of an open or short circuit
- 60 Hz input filter to provide 60 Hz line noise rejection
- use 2.0 mA excitation current for RTD
- select module defined scaling

Configuration setup for steam RTD includes the following:

- channel 2
- 1000 Ω Platinum RTD (385)
- display temperature to tenths of a degree Celsius
- zero data word in the event of an open or short circuit
- 60 Hz input filter to provide 60 Hz line noise rejection
- use 0.5 mA excitation current for RTD
- select module defined scaling

Configuration setup for chilled H₂O RTD the following:

- channel 3
- 200 Ω Platinum RTD (385)
- display temperature to tenths of a degree Celsius
- zero data word in the event of an open or short circuit
- 60 Hz input filter to provide 60 Hz line noise rejection
- use 2.0 mA excitation current for RTD
- select module defined scaling

Channel Configuration Worksheet (With Settings Established)

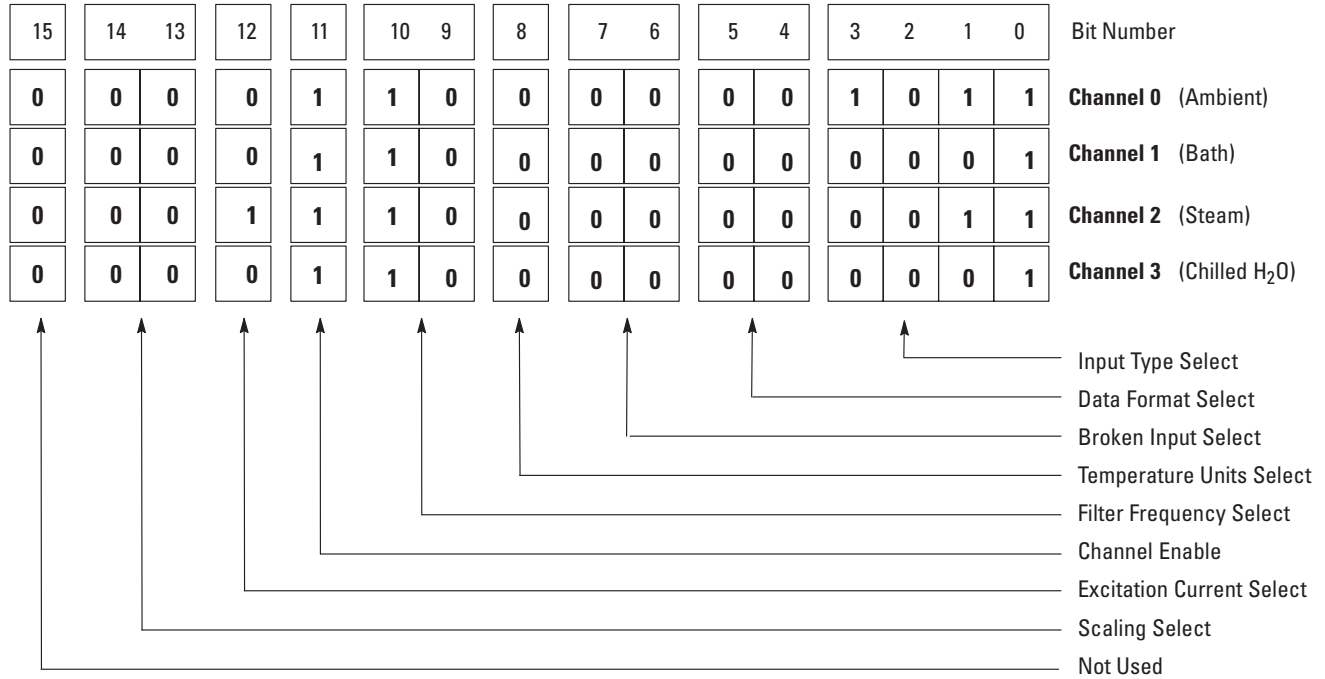

Bits 0...3	Input Type Selected	0000 = 100 Ω Pt. (385) 0001 = 200 Ω Pt. (385) 0010 = 500 Ω Pt. (385) 0011 = 1000 Ω Pt. (385) 0100 = 100 Ω Pt. (3916) 0101 = 200 Ω Pt. (3916)	0110 = 500 Ω Pt. (3916) 0111 = 1000 Ω Pt. (3916) 1000 = 10 Ω Cu (426) ⁽¹⁾ 1001 = 120 Ω Ni (618) ⁽²⁾ 1010 = 120 Ω Ni (617) 1011 = 604 Ω Ni-Fe (518)	1100 = 150 Ω Potentiometer 1001 = 500 Ω Potentiometer 1110 = 1000 Ω Potentiometer 1111 = 3000 Ω Potentiometer
Bits 4 and 5	Data Format Select	00 = engineering units, x 1 ⁽³⁾ 01 = engineering units, x10 ⁽⁴⁾		10 = scaled-for-PID (0 to 16383) 11 = proportional counts (-32768 to +32767)
Bits 6 and 7	Broken Input Select	00 = zero	01 = upscale	10 = downscale 11 = invalid
Bits 8	Temperature Units Select	0 = degrees Celsius 1 = degrees Fahrenheit		
Bits 9 and 10	Filter Frequency Select	00 = 10 Hz	01 = 50 Hz	10 = 60 Hz 11 = 250 Hz
Bit 11	Channel Enable	0 = channel disabled 1 = channel enabled		
Bit 12	Excitation Current Select	0 = 2.0 mA 1 = 0.5 mA		
Bits 13 and 14	Scaling Select	00 = module defined scaling (default)	01 = config. words 4 and 5 for scaling	10 = config words 6 & 7 for scaling 11 = Not used (config error)
Bits 15	Not Used	0 = always make this setting		

⁽¹⁾ Actual value at 0 °C (32 °F) is 9.042 Ω per SAMA standard RC21-4-1966.

⁽²⁾ Actual value at 0 °C (32 °F) is 100 Ω per DIN standard.

⁽³⁾ Values are 0.1 °/step or 0.1 Ω/step for all resistance input types except 150 Ω For the 150 Ω resistance input type, the values are in 0.01 Ω/step.

⁽⁴⁾ Values are 1 °/step or 1 Ω/step for all resistance input types except 150 Ω For the 150 Ω resistance input type, the values are in 0.1 Ω/step.

Program Setup and Operation Summary

1. Set up two configuration words in memory for each channel, one for °C and the other for °F.

Channel	Configuration Word Allocation	
	°F	°C
0	N10:0	N10:4
1	N10:1	N10:5
2	N10:2	N10:6
3	N10:3	N10:7

2. When the position of the degrees selector switch changes, write the appropriate channel configuration to the RTD module.

Note that the use of the OSR instruction (one-shot rising) makes these configuration changes edge-triggered, that is, the RTD unit is reconfigured only when the selector switch changes position.



Degrees Selector Switch

3. Convert the individual RTD data words to BCD and send the data to the respective LED displays.

Program Listing

The first two rungs of this program send the correct channel setup information to the RTD module based on the position of the degrees selector switch.

Program to Display Data on LED Displays

Rung 2.0

If the degrees selector switch is turned to the Fahrenheit position, set up all four channels to read in degrees Fahrenheit.

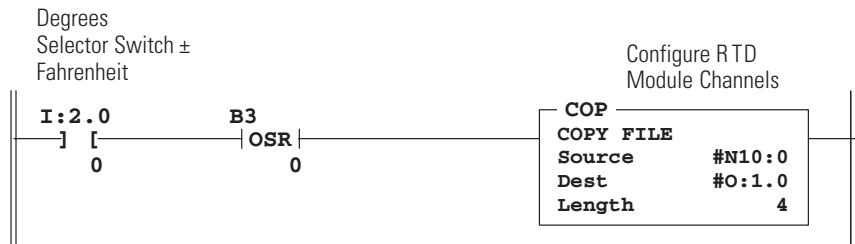

Rung 2.1

If the degrees selector switch is turned to the Celsius position, set up all four channels to read in degrees Celsius.

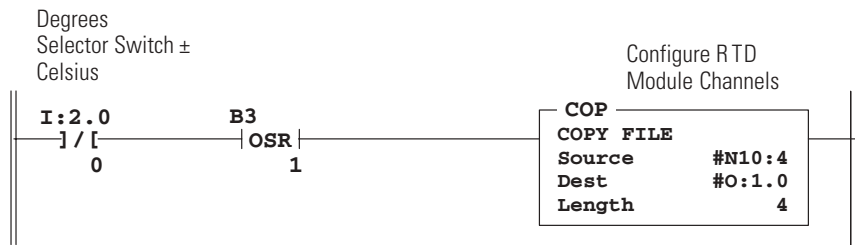

Rung 2.2

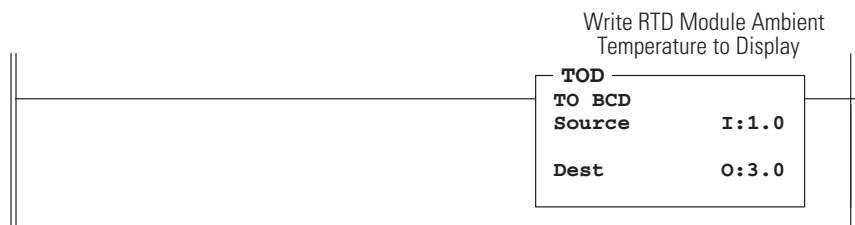

Rung 2.3

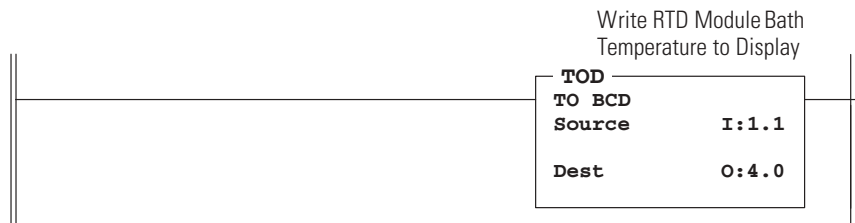

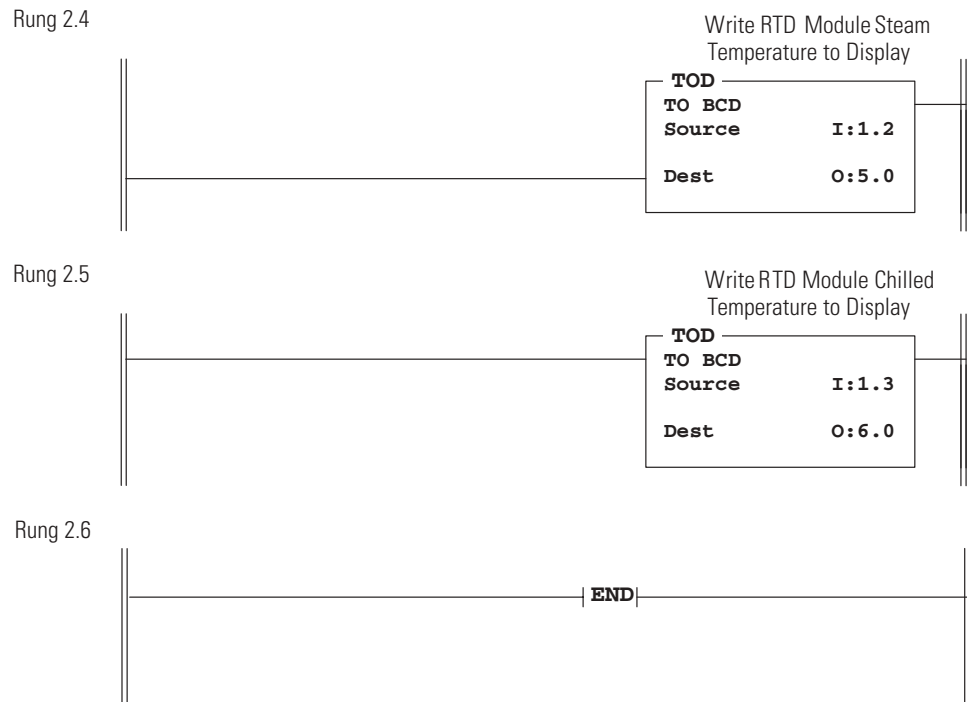

Specifications

This appendix lists the specifications for the 1746-NR4 RTD Input Module.

1746-NR4 Electrical Specifications

Backplane current consumption	50 mA at 5V dc 50 mA at 24V dc
Backplane power consumption	1.5 W max (0.3 W at 5V dc, 1.2 W at 24V dc)
External power supply requirements	None
Number of channels	4 (backplane isolated)
I/O chassis location	Any I/O module slot except slot 0
A/D conversion method	Sigma-delta modulation
Input filtering	Low pass digital filter with programmable notch (filter) frequencies
Common mode rejection (between inputs and chassis ground)	> 150 dB at 50 Hz (10 Hz and 50 Hz filter frequencies) > 150 dB at 60 Hz (10 Hz and 60 Hz filter frequencies)
Normal mode rejection (between [+] input and [-] input)	> 100 dB at 50 Hz (10 Hz, 50 Hz filter frequencies) > 100 dB at 60 Hz (10 Hz, 60 Hz filter frequencies)
Max common mode voltage	±1 volt
Max allowed permanent overload	Volts = ±5V dc Current = ±5 mA
Input filter cut-off frequencies	2.62 Hz at 10 Hz filter frequency 13.1 Hz at 50 Hz filter frequency 15.72 Hz at 60 Hz filter frequency 65.5 Hz at 250 Hz filter frequency
Calibration	Module auto calibrates when a channel is enabled or when a change is made to its input type, filter frequency or excitation current.
Isolation (optical)	500V dc for 1 min between inputs and chassis ground, and between inputs and backplane
Isolation between inputs	None

Physical Specifications

LED indicators	5 green status indicators, one for each of 4 channels and one for module status
Module ID code	3513
Max termination wire size	Two 2.5 mm ² (14 AWG) wire per terminal
Max cable impedance	25 Ω max impedance for three-wire RTD configuration (see Cable Specifications)
Terminal block	Removable, Allen-Bradley spare part Catalog Number 1746-RT25G

Module Environmental Specifications

Temperature, operating	0...60 °C (32...140 °F)
Temperature, storage	-40...85 °C (-40...185 °F)
Relative humidity	5% ... 95% (without condensation)
Hazardous environment classification	Class I, Division 2 Hazardous Environment
Agency certification (when product or packaging is marked)	<ul style="list-style-type: none"> • UL and CSA Class I, Division 2 Groups A, B, C, D certified • CE compliant for all applicable directives

Input Specifications

RTD types	Platinum, nickel, nickel iron, copper
Temperature scale (selectable)	°C or °F and 0.1 °C or 0.1 °F
Resistance scale (selectable)	1 Ω or 0.1 Ω for all resistance ranges; or 0.1 Ω or 0.01 Ω for 150 Ω potentiometer.
Input step response	See channel step response, page 54.
Input resolution and repeatability	See RTD and resistance device compatibility tables on page 13.
Display resolution	See Channel Data Word Resolution table on page 74.
Module update time	See chapter 4, Update Time, page 58.
Channel turn-on time	Requires up to one module update time plus one of the following: <ul style="list-style-type: none"> • 250 Hz Filter = 388 ms • 60 Hz Filter = 1,300 ms • 50 Hz Filter = 1,540 ms • 10 Hz Filter = 7,300 ms

Input Specifications

Channel turn-off time	Requires up to one module update time.
Reconfiguration time	Requires up to one module update time plus one of the following: <ul style="list-style-type: none"> • 250 Hz Filter = 124 ms • 60 Hz Filter = 504 ms • 50 Hz Filter = 604 ms • 10 Hz Filter = 3,004 ms
RTD excitation current	Two current values are user-selectable: <ul style="list-style-type: none"> • 0.5 mA - Recommended for use with higher resistance ranges for both RTDs and direct resistance inputs (1000 Ω RTDs and 3000 Ω resistance input). Refer to RTD manufacturer for recommendations. Cannot use for 10 Ω Copper RTD. • 2.0 mA - Must use for 10 Ω Copper RTD. Recommended to use for all other RTD and direct resistance inputs, except 1000 Ω RTDs and 3000 Ω resistance input ranges are limited. Refer to RTD manufacturer for recommendations.

Module Accuracy

RTD Temperature Ranges, Resolution, and Repeatability

RTD Type		Temp. Range (0.5 mA Excitation) ⁽⁴⁾	Temp. Range (2.0 mA Excitation) ⁽⁴⁾	Resolution	Repeatability
Platinum (385) ⁽¹⁾	100 Ω	-200...850 °C (-328...1562 °F)	-200...850 °C (-328...1562 °F)	0.1 °C (0.2 °F)	± 0.2 °C (± 0.4 °F)
	200 Ω	-200...850 °C (-328...1562 °F)	-200...850 °C (-328...1562 °F)	0.1 °C (0.2 °F)	± 0.2 °C (± 0.4 °F)
	500 Ω	-200...850 °C (-328...1562 °F)	-200...850 °C (-328...1562 °F)	0.1 °C (0.2 °F)	± 0.2 °C (± 0.4 °F)
	1000 Ω	-200...850 °C (-328...1562 °F)	-200...850 °C (-328...1562 °F)	0.1 °C (0.2 °F)	± 0.2 °C (± 0.4 °F)
Platinum (3916) ⁽¹⁾	100 Ω	-200...630 °C (-328...1166 °F)	-200...630 °C (-328...1166 °F)	0.1 °C (0.2 °F)	± 0.2 °C (± 0.4 °F)
	200 Ω	-200...630 °C (-328...1166 °F)	-200...630 °C (-328...1166 °F)	0.1 °C (0.2 °F)	± 0.2 °C (± 0.4 °F)
	500 Ω	-200...630 °C (-328...1166 °F)	-200...630 °C (-328...1166 °F)	0.1 °C (0.2 °F)	± 0.2 °C (± 0.4 °F)
	1000 Ω	-200...630 °C (-328...1166 °F)	-200...230 °C (-328...446 °F)	0.1 °C (0.2 °F)	± 0.2 °C (± 0.4 °F)
Copper (416) ⁽¹⁾⁽²⁾	10 Ω	Not allowed. ⁽⁵⁾	-100...260 °C (-148...500 °F)	0.1 °C (0.2 °F)	± 0.2 °C (± 0.4 °F)

RTD Temperature Ranges, Resolution, and Repeatability

RTD Type		Temp. Range (0.5 mA Excitation) ⁽⁴⁾	Temp. Range (2.0 mA Excitation) ⁽⁴⁾	Resolution	Repeatability
Nickel (618) ⁽¹⁾⁽³⁾	120 Ω	-100...260 °C (-148...500 °F)	-100 ...260 °C (-148...500 °F)	0.1 °C (0.2 °F)	\pm 0.2 °C (\pm 0.4 °F)
Nickel (672) ⁽¹⁾	120 Ω	-80 ...260 °C (-112...500 °F)	-80 ...260 °C (-112 ...500 °F)	0.1 °C (0.2 °F)	\pm 0.2 °C (\pm 0.4 °F)
Nickel Iron (518) ⁽¹⁾	604 Ω	-100 ...200 °C (-148 ...392 °F)	-100 ...200 °C (-148 ...392 °F)	0.1 °C (0.2 °F)	\pm 0.2 °C (\pm 0.4 °F)

⁽¹⁾ The digits following the RTD type represent the temperature coefficient of resistance (α), which is defined as the resistance change per ohm per °C. For instance, Platinum 385 refers to a platinum RTD with $\alpha = 0.00385$ ohms/ohm - °C or simply 0.00385 /°C.

⁽²⁾ Actual value at 0 °C (32 °F) is 9.042 Ω per SAMA standard RC21-4-1966.

⁽³⁾ Actual value at 0 °C (32 °F) is 100 Ω per DIN standard.

⁽⁴⁾ The temperature range for the 1000 Ω RTD is dependant on the excitation current.

⁽⁵⁾ To maximize the relatively small RTD signal, only 2 mA excitation current is allowed.

IMPORTANT

The exact signal range valid for each input type is dependent upon the excitation current magnitude that you select when configuring the module.

For details on excitation current, refer to page 119.

RTD Accuracy and Temperature Drift Specification

RTD Type		Accuracy (0.5 mA Excitation) ⁽⁴⁾	Accuracy (2.0 mA Excitation) ⁽⁴⁾	Temperature Drift (0.5 mA Excitation) ⁽⁶⁾	Temperature Drift (2.0 mA Excitation) ⁽⁶⁾
Platinum (385) ⁽¹⁾	100 Ω	\pm 1.0 °C (\pm 2.0 °F)	\pm 0.5 °C (\pm 0.9 °F)	\pm 0.034 °C/°C (\pm 0.061 °F/°F)	\pm 0.014 °C/°C (\pm 0.025 °F/°F)
	200 Ω	\pm 1.0 °C (\pm 2.0 °F)	\pm 0.5 °C (\pm 0.9 °F)	\pm 0.034 °C/°C (\pm 0.061 °F/°F)	\pm 0.014 °C/°C (\pm 0.025 °F/°F)
	500 Ω	\pm 0.6 °C (\pm 1.1 °F)	\pm 0.5 °C (\pm 0.9 °F)	\pm 0.017 °C/°C (\pm 0.031 °F/°F)	\pm 0.014 °C/°C (\pm 0.025 °F/°F)
	1000 Ω	\pm 0.6 °C (\pm 1.1 °F)	\pm 0.5 °C (\pm 0.9 °F)	\pm 0.017 °C/°C (\pm 0.031 °F/°F)	\pm 0.014 °C/°C (\pm 0.025 °F/°F)
Platinum (3916) ⁽¹⁾	100 Ω	\pm 1.0 °C (\pm 2.0 °F)	\pm 0.4 °C (\pm 0.7 °F)	\pm 0.034 °C/°C (\pm 0.061 °F/°F)	\pm 0.011 °C/°C (\pm 0.020 °F/°F)
	200 Ω	\pm 1.0 °C (\pm 2.0 °F)	\pm 0.4 °C (\pm 0.7 °F)	\pm 0.034 °C/°C (\pm 0.061 °F/°F)	\pm 0.011 °C/°C (\pm 0.020 °F/°F)
	500 Ω	\pm 0.5 °C (\pm 0.9 °F)	\pm 0.4 °C (\pm 0.7 °F)	\pm 0.014 °C/°C (\pm 0.025 °F/°F)	\pm 0.011 °C/°C (\pm 0.020 °F/°F)
	1000 Ω	\pm 0.5 °C (\pm 0.9 °F)	\pm 0.4 °C (\pm 0.7 °F)	\pm 0.014 °C/°C (\pm 0.025 °F/°F)	\pm 0.011 °C/°C (\pm 0.020 °F/°F)

RTD Accuracy and Temperature Drift Specification

RTD Type		Accuracy (0.5 mA Excitation) ⁽⁴⁾	Accuracy (2.0 mA Excitation) ⁽⁴⁾	Temperature Drift (0.5 mA Excitation) ⁽⁶⁾	Temperature Drift (2.0 mA Excitation) ⁽⁶⁾
Copper (426) ⁽¹⁾⁽²⁾	10 Ω	Not allowed. ⁽⁵⁾	± 0.6 °C (± 1.1 °F)	Not allowed.	± 0.017 °C/°C (± 0.031 °F/°F)
Nickel (618) ⁽¹⁾⁽³⁾	120 Ω	± 0.2 °C (± 0.4 °F)	± 0.2 °C (± 0.4 °F)	± 0.008 °C/°C (± 0.014 °F/°F)	± 0.008 °C/°C (± 0.014 °F/°F)
Nickel (672) ⁽¹⁾	120 Ω	± 0.2 °C (± 0.4 °F)	± 0.2 °C (± 0.4 °F)	± 0.008 °C/°C (± 0.014 °F/°F)	± 0.008 °C/°C (± 0.014 °F/°F)
Nickel Iron (518) ⁽¹⁾	604 Ω	± 0.3 °C (± 0.5 °F)	± 0.3 °C (± 0.5 °F)	± 0.010 °C/°C (± 0.018 °F/°F)	± 0.010 °C/°C (± 0.018 °F/°F)

⁽¹⁾ The digits following the RTD type represent the temperature coefficient of resistance (α), which is defined as the resistance change per ohm per °C. For instance, Platinum 385 refers to a platinum RTD with $\alpha = 0.00385$ ohms/ohm-°C or simply 0.00385 /°C.

⁽²⁾ Actual value at 0 °C (32 °F) is 9.042 Ω per SAMA standard RC21-4-1966.

⁽³⁾ Actual value at 0 °C (32 °F) is 100 Ω per DIN standard.

⁽⁴⁾ The accuracy values assume that the module was calibrated within the specified temperature range of 0...60 °C (32...140 °F).

⁽⁵⁾ To maximize the relatively small RTD signal, only 2 mA excitation current is allowed.

⁽⁶⁾ Temperature drift specifications apply to a module that has not been calibrated.

When you are using 100 Ω or 200 Ω platinum RTDs with 0.5 mA excitation current, refer to the following important note about module accuracy.

IMPORTANT

Module accuracy, using 100 Ω or 200 Ω platinum RTDs with 0.5 mA excitation current, depends on the following criteria:

- Module accuracy is ± 0.6 °C after you apply power to the module or perform an autocalibration at 25 °C (77 °F) ambient with module operating temperature at 25 °C (77 °F).
- Module accuracy is $\pm (0.6$ °C + DT ± 0.034 °C/°C) after you apply power to the module or perform an autocalibration at 25 °C (77 °F) ambient with the module operating temperature between 0...60 °C. Where DT is the temperature difference between the actual operating temperature of the module and 25 °C (140 °F) and 0.034 °C/°C is the temperature drift shown in the table above for 100 Ω or 200 Ω platinum RTDs.
- Module accuracy is ± 1.0 °C after you apply power to the module or perform an autocalibration at 60 °C (140 °F) ambient with module operating temperature at 60 °C (140 °F).

Resistance Device Compatibility

Resistance Input Specification

Input Type	Resistance Range (0.5 mA Excitation)	Resistance Range (2.0 mA Excitation)	Accuracy ⁽¹⁾	Temperature Drift	Resolution	Repeatability	
Resistance	150 Δ	0 Δ to 150 Δ	0 Δ to 150 Δ	(2)	(3)	0.01 Δ	X 0.4 Δ
	500 Δ	0 Δ to 500 Δ	0 Δ to 500 Δ	X 0.5 Δ	X 0.014 $\Delta/^\circ\text{C}$ (X 0.025 $\Delta/^\circ\text{F}$)	0.1 Δ	X 0.2 Δ
	1000 Δ	0 Δ to 1000 Δ	0 Δ to 1000 Δ	X 1.0 Δ	X 0.029 $\Delta/^\circ\text{C}$ (X 0.052 $\Delta/^\circ\text{F}$)	0.1 Δ	X 0.2 Δ
	3000 Δ	0 Δ to 3000 Δ	0 Δ to 1900 Δ	X 1.5 Δ	X 0.043 $\Delta/^\circ\text{C}$ (X 0.077 $\Delta/^\circ\text{F}$)	0.1 Δ	X 0.2 Δ

⁽¹⁾ The accuracy value assumes that the module was calibrated within the specified temperature range of 0...60 $^\circ\text{C}$ (32...140 $^\circ\text{F}$).

⁽²⁾ The accuracy for 150 Ω is dependent on the excitation current:
 X 0.2 Ω at 0.5 mA
 X 0.15 Ω at 2.0 mA

⁽³⁾ The temperature drift for 150 Ω is dependent on the excitation current:
 X 0.006 $\Omega/^\circ\text{C}$ at 0.5 mA
 X 0.004 Ω at 2.0 mA

Cable Specifications

Description	Belden #9501	Belden #9533	Belden #83503
When used?	For two-wire RTDs and potentiometer	For three-wire RTDs and potentiometers. Short runs less than 100 feet and normal humidity levels	For three-wire RTDs and potentiometers. Long runs greater than 100 feet or high humidity levels
Conductors	Two, 0.205 mm ² (24 AWG) tinned copper (7x 32)	Three, 0.205 mm ² (24 AWG) tinned copper (7x 32)	Three, 0.205 mm ² (24 AWG) tinned copper (7x 32)
Shield	Beldfoil aluminum polyester shield with copper drain wire.	Beldfoil aluminum polyester shield with copper drain wire.	Beldfoil aluminum polyester shield with tinned braid shield.
Insulation	PVC	S-R PVC	Teflon
Jacket	Chrome PVC	Chrome PVC	Red Teflon
Agency approvals	NEC Type CM	NEC Type CM	NEC ART-800, Type CMP
Temperature rating	80 $^\circ\text{C}$ (176 $^\circ\text{F}$)	80 $^\circ\text{C}$ (176 $^\circ\text{F}$)	200 $^\circ\text{C}$ (392 $^\circ\text{F}$)

RTD Standards

The following table shows various international and local RTD standards that apply to the 1746-NR4:

RTD Type	α ⁽¹⁾	EIC ⁽²⁾	DIN ⁽³⁾	D100 ⁽⁴⁾	SAMA ⁽⁵⁾	JIS (old) ⁽⁶⁾	JIS (new) ⁽⁷⁾	Minco ⁽⁸⁾
100 Ω Platinum	0.00385	X	X				X	
200 Ω Platinum	0.00385	X	X				X	
500 Ω Platinum	0.00385	X	X				X	
1000 Ω Platinum	0.00385	X	X				X	
100 Ω Platinum	0.03916			X		X		
200 Ω Platinum	0.03916			X		X		
500 Ω Platinum	0.03916			X		X		
1000 Ω Platinum	0.03916			X		X		
10 Ω Copper ⁽⁹⁾	0.00426				X			
120 Ω Nickel ⁽¹⁰⁾	0.00672		X					
120 Ω Nickel	0.00672							X
604 Ω Nickel Iron	0.00518							X

⁽¹⁾ α is the temperature coefficient of resistance which is defined as the resistance change per ohm per °C.

⁽²⁾ International Electrotechnical Commission Standard 751-1983.

⁽³⁾ German Standard, DIN 43760-1980 and DIN 43760-1987.

⁽⁴⁾ U.S. Standard D100.

⁽⁵⁾ Scientific Apparatus Makers Association Standard RC21-4-1966.

⁽⁶⁾ Japanese Industrial Standard JIS C1604-1981.

⁽⁷⁾ Japanese Standard JIS C1604-1989.

⁽⁸⁾ Minco Type 'NA' (Nickel) and Minco Type 'FA' (Nickel-Iron).

⁽⁹⁾ Actual value at 0 °C (32 °F) is 9.042 W per SAMA standard RC21-4-1966.

⁽¹⁰⁾ Actual value at 0 °C (32 °F) is 100 W per DIN standard.

ATTENTION



We recommend you use RTDs that conform to the standards in the table above. Failure to heed this caution may result in reduced accuracy of the RTD system.

Notes:

Configuration Worksheet for RTD/Resistance Module

The following configuration procedure and worksheet are provided to help you configure each of the channels on your RTD module. The channel configuration word consists of bit fields, the settings of which determine how the channel will operate. This procedure looks at each bit field separately and helps you configure a channel for operation.

Refer to the Channel Configuration Word (O:e.0 through O:e.3) - Bit Definitions table and the detailed configuration information in Chapter 5 as needed to complete the procedures in this appendix. Or you may prefer to use the summary worksheet on page 128.

Channel Configuration Procedure

Proceed as follows.

1. Determine the input device type (RTD type or resistance input) for a channel and enter its respective 4-digit binary code in bit field 0...3 of the channel configuration word.

Bits 0-3	RTD Sensors/Setting										Resistance Input/Setting	
	Platinum ($\infty = 0.00385$)		Platinum ($\infty = 0.003916$)		Copper ($\infty = 0.00426$)		Nickel ($\infty = 0.00618$) ($\infty = 0.00672$)		Nickel Iron ($\infty = 0.00518$)			
Select Input Type	100 Ω	0000	100 Ω	0100	10 Ω ⁽¹⁾	1000	120 Ω	1001	604 Ω	1011	150 Ω	1100
	200 Ω	0001	200 Ω	0101	-	-	120 Ω ⁽²⁾	1010	-	-	500 Ω	1101
	500 Ω	0010	500 Ω	0110	-	-	-	-	-	-	1000 Ω	1110
	1000 Ω	0011	1000 Ω	0111	-	-	-	-	-	-	3000 Ω	1111

⁽¹⁾ Actual value at 0 °C (32 °F) is 9.042 Ω per SAMA standard RC21-4-1966.

⁽²⁾ Actual value at 0 °C (32 °F) is 100 Ω per DIN standard.

2. Select a data format for the data word value.

Your selection determines how the analog input value registered by the analog sensor will be expressed in the data word. Enter your 2-digit binary code in bit field 4 and 5 of the channel configuration word.

IMPORTANT

Complete step 8 if you select proportional counts data format.

Bits 4 and 5	Select Data Format	<p>00 = engineering units, x1: 0.1°/step, 0.1 Ω/ step and 0.01 Ω/ step (150Ω only).</p> <p>01 = engineering units, x10: 1°/step, 1 Ω/ step, (150 Ω only).</p> <p>10 = scaled-for-PID (0 to 16383)</p> <p>11 = proportional counts (-32768 to +32767) (Refer to select scaling bits 13 and 14).</p>
---------------------	--------------------	--

3. Determine the desired state for the channel data word if an open or short circuit (RTD only) condition is detected for that channel.

4. Enter the 2-digit binary code in bit field 6 and 7 of the channel configuration word.

Bits 6 and 7	Select Broken Input State	00 = zero 01 = upscale 10 = downscale 11 = invalid
---------------------	---------------------------	---

5. If the channel is configured for RTD inputs, determine if you want the channel data word to read in degrees Fahrenheit (1) or degrees Celsius (0) and enter a one or a zero in bit 8 of the configuration word.

Bits 8	Select Temperature Units	0 = degrees Celsius 1 = degrees Fahrenheit
---------------	--------------------------	---

6. Determine the desired input filter frequency for the channel and enter the 2-digit binary code in bit field 9 and 10 of the channel configuration word.

A smaller filter frequency increases the channel update time, but also increases the noise rejection. A larger filter frequency decreases the noise rejection, but also decreases the channel update time.

Bits 9 and 10	Select Filter Frequency	00 = 10 Hz	01 = 50 Hz	10 = 60 Hz	11 = 250 Hz
----------------------	-------------------------	------------	------------	------------	-------------

7. If the channel will be used in your system, it must be enabled by placing a one in bit 11 if the channel is to be enabled or a zero in bit 11 if the channel is to be disabled.

Bit 11	Channel Enable	0 = channel disable 1 = channel enabled
---------------	----------------	--

8. Select the excitation current for the inputs.

A zero in bit 12 provides an excitation current of 2.0 mA; a 1 will provide 0.5 mA.

Bit 12	Excitation Current	0 = excitation current = 2.0 mA 1 = excitation current = 0.5 mA
---------------	--------------------	--

9. If you have selected scaled-for-PID or proportional counts data formats, you can choose module defined scaling (this applies the scale associated with your data format selection in step 2).

In addition, use bits 13 and 14 if you want to define the scaling range yourself for proportional counts data format (user-set scaling). If you choose to define the scaling range for proportional counts, make sure to enter the lower and upper user-set limits in words 4 and 5 (defines range 0) or 6 and 7 (defines range 1).

Refer to Chapter 5.

Bits 13 and 14	Select Scaling	00 = module defined scaling 01 = configuration words 4 and 5 used for scaling (range 0) 10 = configuration words 6 and 7 used for scaling (range 1) 11 = not used (invalid setting)
-----------------------	----------------	--

10. Make sure a zero is in bit 15. This bit is not used.

11. Build the channel configuration word for every channel that is being used on each RTD module repeating the procedures given in steps 1...10.
12. Enter the completed configuration words for each module into the summary worksheet on the following page.
13. Following the steps outlined in Chapter 6, Ladder Programming Examples, enter this configuration data into your ladder program and copy it to the RTD module.

Channel Configuration Worksheet

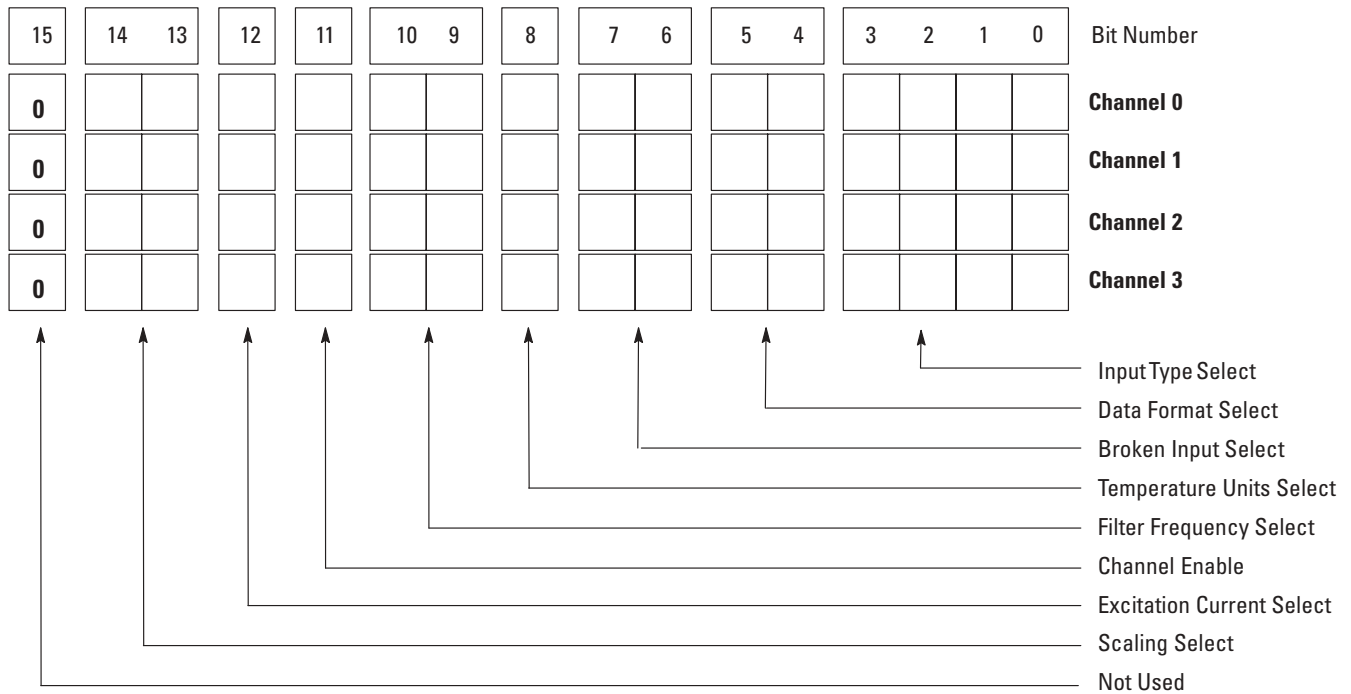

Bit Definitions

Bits 0...3	Input Type Select	0000 = 100 ΩPt. (385) 0001 = 200 ΩPt. (385) 0010 = 500 ΩPt. (385) 0011 = 1000 ΩPt. (385) 0100 = 100 ΩPt. (3916) 0101 = 200 ΩPt. (3916)	0110 = 500 ΩPt. (3916) 0111 = 1000 ΩPt. (3916) 1000 = 10 ΩCu (427) ⁽¹⁾ 1001 = 120 ΩNi (618) ⁽²⁾ 1010 = 120 ΩNi (672) 1011 = 604 ΩNi-Fe (518)	1100 = 150 Ω 1101 = 500 Ω 1110 = 1000 Ω 1111 = 3000 Ω
Bits 4 and 5	Data Format Select	00 = engineering units, x1 ⁽³⁾ 01 = engineering units, x10 ⁽⁴⁾		10 = scaled-for-PID (0...16,383) 11 = proportional counts(-32,768...32,767)
Bits 6 and 7	Broken Input Select	00 = zero	01 = upscale	10 = downscale 11 = invalid
Bit 8	Temperature Units Select	0 = degrees Celsius 1 = degrees Fahrenheit		

Bits 9 and 10	Filter Frequency Select	00 = 10 Hz	01 = 50 Hz	10 = 60 Hz	11 = 250 Hz
Bit 11	Channel Enable	0 = channel disabled	1 = channel enabled		
Bit 12	Excitation Current Select	0 = 0.2 mA	1 = 0.5 mA		
Bit 13 and 14	Scaling Select	00 = module defined scaling (default)	01 = config. words 4 & 5 for scaling	10 = config. words 6 & 7 for scaling	11 = Not used (config error)
Bit 15	Not Used	0 = always make this setting			

⁽¹⁾ Actual value at 0 °C (32 °F) is 9.04 Ω per SAMA standard RC21-4-1966.

⁽²⁾ Actual value at 0 °C (32 °F) is 100 Ω per DIN standard.

⁽³⁾ Values are expressed in 0.1 degree/step or 0.1 Ω /step (applies to all pots, except 150 Ω type). For the 150 Ω pot input type, the values are expressed in 0.01 Ω /step.

⁽⁴⁾ Values are expressed in 1 degree/step or 1 Ω /step (applies to all pot, except 150 Ω type). For the 150 Ω pot input type, the values are expressed in 0.1 Ω /step.

Notes:

I/O Configuration

This section contains information on the I/O configuration procedure for RSLogix 500 Version 6.0 and later software.

1. Open the IO Configuration in RSLogix 500 software.
2. Add the 1746-NR4 module in the correct rack slot.

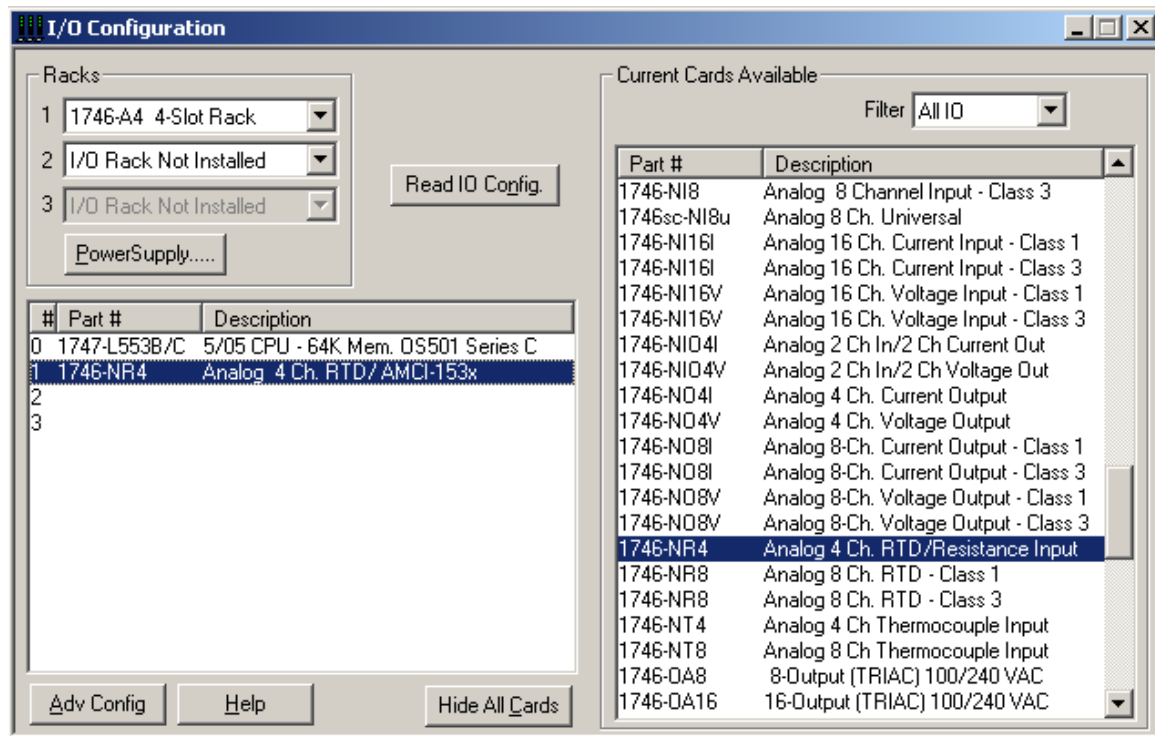

3. Click Adv Config to access more configuration options.

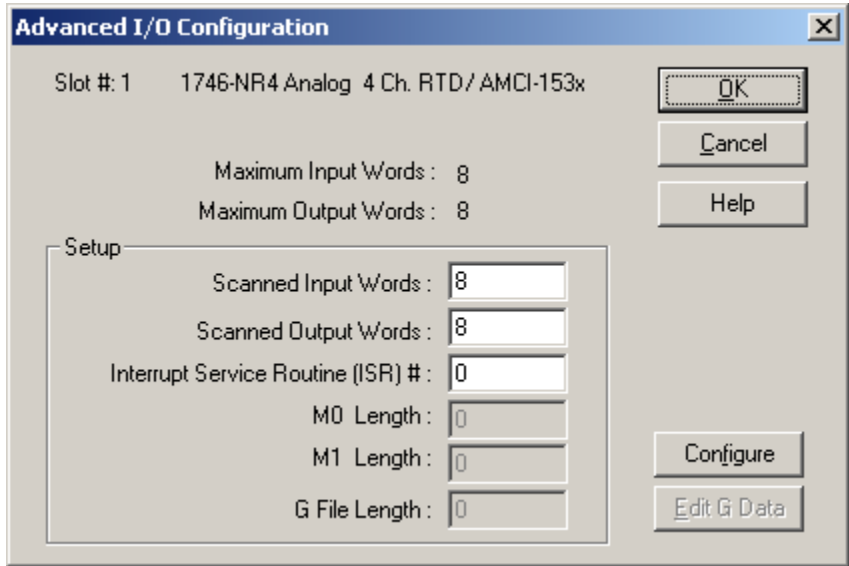

4. Click Configure to access the channel configuration options.

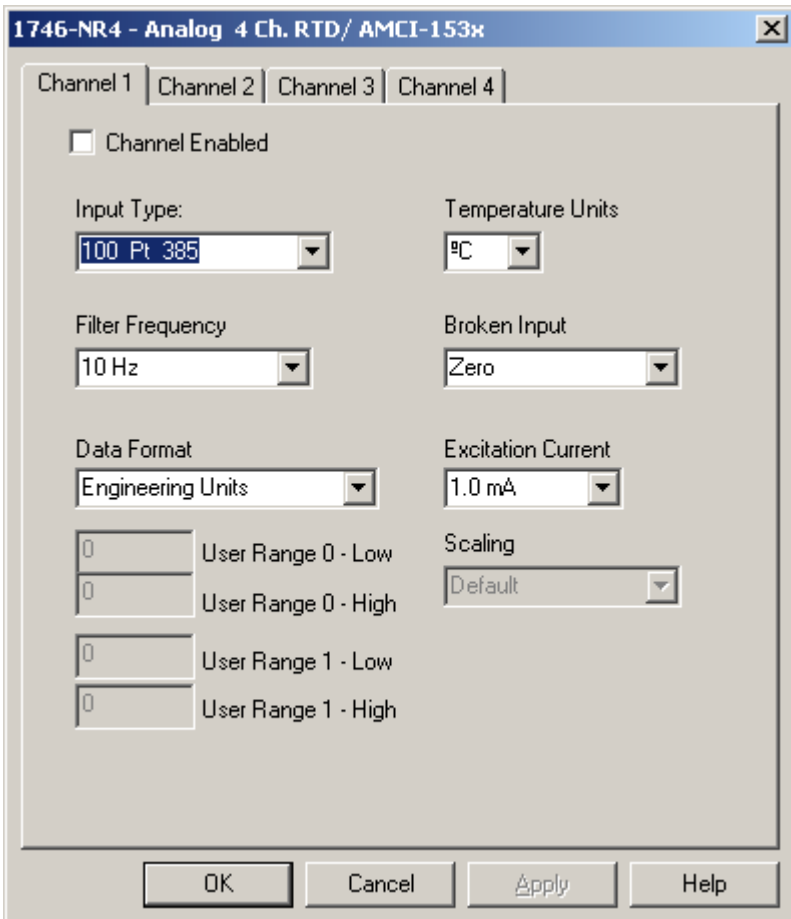

Each tab is labeled with the corresponding channel that it will configure. The pull down menus let you chose the various parameters for the channel.

Each menu effects the corresponding bits for the configuration data file.

Input Type changes bits 0...3 and chooses the type of RTD/Resistance input.

Data Format changes bits 4...5 and selects between engineering units and scaled for PID

Broken Input changes bits 6...7 and chooses how to handle an open circuit condition

Temperature Units changes bit 8 and selects Fahrenheit or Celsius.

Filter Frequency changes bits 9...10 and sets the cutoff frequency of the channel filter

Clicking the Channel Enable box will set bit 11 and either enable or disable the channel

The Excitation Current changes bit 12 and chooses 1 mA or 0.5 mA of excitation current

If Raw/Proportional is selected under data format, the options for scaling and user ranges may become available.

5. Click OK to apply the changes after all channel parameters have been chosen.

The following screen appears and gives you the opportunity to chose where in the ladder logic to place the configuration rung.

Configuration Rung and Data

Integer Data File Number: 9

Integer Data Element: 0

Rung to be inserted: XIC S2:1/15 COP #N9:0 #O0:1.0 8

At Program File Number: 2 Top

OK

Cancel

6. Click OK.

RSLogix 500 software automatically places a rung in the ladder logic that you defined.

The data file is also automatically changed to match the channel parameters entered.

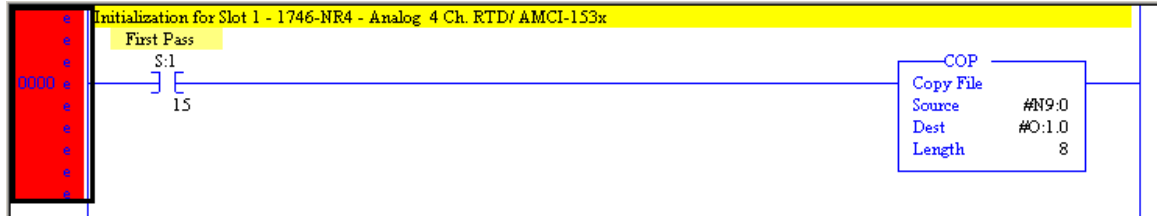

The following terms and abbreviations are specific to this product. For a complete listing of Allen-Bradley terminology, refer to the Allen-Bradley Industrial Automation Glossary, Publication Number AG-7.1.

A/D

Refers to the analog-to-digital converter inherent to the RTD/Resistance input module. The converter produces a digital value whose magnitude is proportional to the instantaneous magnitude of an analog input signal.

attenuation

The reduction in the magnitude of a signal as it passes through a system.

channel

Refers to one of four small-signal analog input interfaces available on the module's terminal block. Each channel is configured for connection to an RTD or potentiometer input device and has its own diagnostic status word.

chassis

A hardware assembly that houses devices such as I/O modules, adapter modules, processor modules, and power supplies.

common mode rejection ratio

The ratio of a device's differential voltage gain to common mode voltage gain, expressed in dB.

CMRR

$$20 \text{ Log}_{10} (V_1/V_2)$$

common mode voltage

A voltage signal induced in conductors with respect to ground (0 potential).

configuration word

Contains the channel configuration information needed by the module to configure and operate each channel. Information is written to the configuration word through the logic supplied in your ladder program.

cut-off frequency

The frequency at which the input signal is attenuated 3 dB by the digital filter. Frequency components of the input signal below the cut-off frequency are passed with under 3 dB of attenuation.

data word

A 16-bit integer that represents the value of the analog input channel. The channel data word is valid only when the channel is enabled and there are no channel errors. When the channel is disabled, the channel data word is cleared (0).

dB (decibel)

A logarithmic measure of the ratio of two signal levels.

digital filter

A low-pass noise filter incorporated into the A/D converter. In addition, the digital filter provides high-rejection notches at frequencies that are integral multiples of the filter cut-off frequency. The notches are used for rejecting AC power line noise and higher frequency noise.

excitation current

A user-selectable current (0.5 mA and 2.0 mA) that the module sends through the RTD or resistive device to produce an analog signal which the NR4 can process and convert to temperature or to ohms, respectively.

effective resolution

The amount of jitter (data variation) that typically occurs in the data word due to the influence of the internal electrical noise in the module.

filter frequency

The user-selectable first-notch frequency for the A/D converter's digital filter. The digital filter provides AC power line noise rejection when the first notch is at 10 Hz or at the power line frequency.

full scale error (gain error)

The difference in slope between the actual and ideal potentiometer or RTD transfer functions.

full scale range (FSR)

The difference between the maximum and minimum specified analog RTD or resistive input values.

gain drift

The change in full scale transition voltage measured over the operating temperature range of the module.

input data scaling

The data formats that you select to define the logical increments of the channel data word. These may be scaled-for-PID, or Engineering Units for RTD or potentiometer inputs, which are automatically scaled. They may also be proportional counts, which you must calculate to fit your application's temperature or resistance resolution.

local configuration

A control system where all the chassis are located within several feet of the processor and chassis-to-chassis communication is via a 1746-C7 or 1746-C9 ribbon cable.

LSB (Least Significant Bit)

Refers to a data increment defined as the full scale range divided by the resolution. The LSB represents the smallest value within a string of bits.

multiplexer

A switching system that allows several input signals to share a common A/D converter.

normal mode rejection (differential mode rejection)

A logarithmic measure in dB, of a device's ability to reject noise signals between or among circuit signal conductors, but not between equipment grounding conductor or signal reference structure and the signal conductors.

potentiometer (Pot)

A variable resistor that can be connected to the RTD module.

remote configuration

A control system where the chassis can be located several thousand feet from the processor chassis. Chassis communication is via the 1747-SN Scanner and 1747-ASB Remote I/O Adapter.

resolution

The smallest detectable change in a measurement, typically expressed in engineering units (for example, 0.1 °C) or as a number of bits. For example, a 12-bit system has 4,096 possible output states. It can, therefore, measure 1 part in 4096.

RTD (Resistance Temperature Detector)

A temperature sensing element with 2, 3, or 4 lead wires. It uses the basic characteristic that electrical resistance of metals increases with temperature. When a small current is applied to the RTD, it creates a voltage that varies with temperature. This voltage is processed and converted by the RTD module into a temperature value.

sampling time

The time required by the A/D converter to sample an input channel.

status word

Contains status information about the channel's current configuration and operational state. You can use this information in your ladder program to determine whether the channel data word is valid.

step response time

This is the time required for the A/D input signal to reach 100% of its expected final value, given a large step change in the input signal.

update time

The time required for the module to sample and convert the input signals of all enabled input channels and make the resulting data values available to the SLC processor.

A

- A/D** 135
- addressing** 52
 - configuration word 52
 - addressing example 52
 - data word 53
 - status words 53
 - addressing example 53
- alarms** 96
- application examples** 107
- attenuation** 135
- autocalibration** 97
 - how to invoke 97
 - when to use it 97

B

- bit allocation** 66
 - in configuration word 66
 - in status word 83
- broken circuit** 75
 - downscale enable 75
 - upscale enable 75
 - zero 75
- broken input**
 - bit description in configuration word 75
 - bit description in status word 84
- broken input error**
 - bit description in status word 85

C

- cable tie slots** 17
- calibration** 47
 - auto cal 47
 - factory cal 47
 - single-point cal 48
- CE Certification** 33
- channel**
 - calibration times 58
 - configuration error 102
 - bit description in status word 86
 - definition 135
 - filter frequency 54
 - effects on noise filtering 54
 - effects on update time 54
- channel status bit** 85
 - bit description in status word 85
- channel timing**
 - channel scan time 58
 - update time 58
- chassis** 135

- CMRR** 135
- common mode rejection ratio** 135
- common mode voltage** 135
- compatibility** 13
 - with RTD sensors 13
 - with SLC controllers 13
- configuration word** 52, 63, 80, 135
- configuring a channel** 63
- connection diagram** 40
- current consumption** 34, 117
- cut-off frequency** 136

D

- data word** 136
 - data resolution 74
- data word format** 74
 - bit description in configuration word 74
 - bit description in status word 84
 - dacling ranges by input type 72
- dB** 136
- decibel** 136
- default setting of configuration word** 63
- diagnostics** 99
 - at power-up 100
 - channel diagnostics 100
- differential mode rejection** 137
- digital filter** 136
- disabling a channel** 77
- door label** 17

E

- effective resolution**
 - definition 136
- electostatic damage** 33
- electrical noise** 33
- electrical specifications** 117
- EMC directive** 33
- enabling a channel** 76
 - bit description in configuration word 76
- engineering units inputs** 67
- equipment required for installation** 23
- error codes** 102
- errors** 102
 - configuration error 102
 - detecting channel-related errors 102
 - open circuit 103
 - over-range error 103
 - under-range error 103
 - detecting module-related errors 104
 - conditions tested at power-up 104

European Union Directives Compliance

33

examples

- how to address configuration word 52
- how to address data word 53
- how to address status word 53
- how to use PID instruction 93
- how to use proportional counts data 95
- using alarms to indicate status 96
- verifying channel configuration changes 92

excitation current 85, 136

- bit description in status word 85

F**filter frequency** 136

- bit description in configuration word 76
- bit description in status word 85

full scale error 136**full scale range** 137**G****gain drift** 137**gain error** 136**grounding**

- cable shield 40
- guidelines 40

H**hardware overview** 16**heat considerations** 37**I****image table**

- input image 22
- output image 22

input channel multiplexing 19**input data scaling** 137**input device type** 67

- bit description in status word 84
- in configuration word 67

installation

- equipment required 23
- heat and noise considerations 37
- in fixed controller expansion chassis 37
- in modular chassis 35

L**LED indicators** 17

- channel status 17, 20
- module status 17, 20

LSB 137**M****module accuracy** 119**module ID code** 51

- how to enter 51

module operation 19**module to processor communication**

- channel configuration word 21
- channel data word 22
- channel limit words 22
- channel status word 22

multiplexer 137**multiplexing** 19**N****noise filtering** 54**normal mode rejection** 137**O****open-circuit** 103

- error condition 103

out-of-range error 103

- bit description in status word 86
- over-range error
 - fault bit 86
- under-range error 86
 - fault bit 86

output image 52**over-range error** 86

- fault indicator bit 86

P**PID input type** 68**PID instruction** 93

- application example 93
- programming 93

pinout diagram 40**potentiometer** 122, 137

- 2-wire pot interconnection 44
- 3-wire pot interconnection 45
- accuracy 122
- ohmic values 122
- power requirements 34

- repeatability 122
- resolution 122
- wiring diagram 44, 45
- wiring inputs 42
- programming** 87
 - configuration settings
 - initial settings 88
 - making changes 88
 - PID instruction 93
 - verifying channel configuration changes 92
- proportional counts data format** 95
 - application example 95
 - programming 95
- proportional counts input** 68

R

- remote configuration** 138
- removing the module** 38
- removing the terminal block** 38
- resistance device types** 122
 - ohmic values 122
 - potentiometer 122
- resolution** 138
- routing of wires** 40
- RTD**

- accuracy 14
- compatibility 16
- definition 138
- excitation current 13
- temperature drift 16
- temperature ranges 119
- theory 11
- types 11, 119

S

- sampling time** 138
- scaled-for-PID** 67
- scaling** 78
- self-locking tabs** 17
- shield connections** 41

- single-point calibration** 48
- slot disabling** 61
- specifications** 117, 122
 - cable 122
 - electrical 117
 - module accuracy 119
- start-up instructions** 23
- status word** 82, 138
- step response** 138
- system operation** 18

T

- temperature units** 76
 - bit description in configuration word 76
- terminal pinout diagram** 40
- terminal wiring** 40
 - 2-wire RTD interconnection 41
 - 3-wire RTD interconnection 41
 - 4-wire RTD interconnection 41
- tools required for installation** 23
- torque** 42
 - terminal block screws 42
- troubleshooting** 99
 - LED examination 100
- turn-off time** 61
- turn-on time** 61

U

- under-range error** 86
 - fault bit 86
- update time** 138
 - channel update time 58
 - effects of filter time setting 54
 - module update time 59

W

- wiring** 33
 - routing of wires 40
 - terminal wiring 40
 - shield connections 40



How Are We Doing?

Your comments on our technical publications will help us serve you better in the future. Thank you for taking the time to provide us feedback.

You can complete this form and mail (or fax) it back to us or email us at RADocumentComments@ra.rockwell.com

Pub. Title/Type SLC 500 RTD/Resistance Input Module

Cat. No. 1746-NR4 Pub. No. 1746-UM008B-EN-P Pub. Date December 2006 Part No. XXXXXX-XX

Please complete the sections below. Where applicable, rank the feature (1=needs improvement, 2=satisfactory, and 3=outstanding).

Overall Usefulness 1 2 3	How can we make this publication more useful for you?		
Completeness (all necessary information is provided) 1 2 3	Can we add more information to help you?		
	procedure/step	illustration	feature
	example	guideline	other
	explanation	definition	
Technical Accuracy (all provided information is correct) 1 2 3	Can we be more accurate?		
	text	illustration	
Clarity (all provided information is easy to understand) 1 2 3	How can we make things clearer?		
Other Comments	You can add additional comments on the back of this form.		

Your Name _____
 Your Title/Function _____
 Location/Phone _____

Would you like us to contact you regarding your comments?
 No, there is no need to contact me
 Yes, please call me
 Yes, please email me at _____
 Yes, please contact me via _____

Return this form to: Rockwell Automation Technical Communications, 1 Allen-Bradley Dr., Mayfield Hts., OH 44124-9705
 Fax: 440-646-3525 Email: RADocumentComments@ra.rockwell.com

PLEASE FASTEN HERE (DO NOT STAPLE)

Other Comments

PLEASE FOLD HERE

PLEASE REMOVE

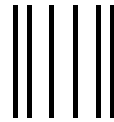

NO POSTAGE
NECESSARY
IF MAILED
IN THE
UNITED STATES

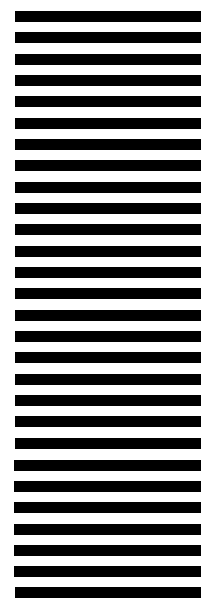

BUSINESS REPLY MAIL
FIRST-CLASS MAIL PERMIT NO. 18235 CLEVELAND OH

POSTAGE WILL BE PAID BY THE ADDRESSEE



**Rockwell
Automation**

1 ALLEN-BRADLEY DR
MAYFIELD HEIGHTS OH 44124-9705



Rockwell Automation Support

Rockwell Automation provides technical information on the Web to assist you in using its products. At <http://support.rockwellautomation.com>, you can find technical manuals, a knowledge base of FAQs, technical and application notes, sample code and links to software service packs, and a MySupport feature that you can customize to make the best use of these tools.

For an additional level of technical phone support for installation, configuration, and troubleshooting, we offer TechConnect Support programs. For more information, contact your local distributor or Rockwell Automation representative, or visit <http://support.rockwellautomation.com>.

Installation Assistance

If you experience a problem with a hardware module within the first 24 hours of installation, please review the information that's contained in this manual. You can also contact a special Customer Support number for initial help in getting your module up and running.

United States	1.440.646.3223 Monday – Friday, 8am – 5pm EST
Outside United States	Please contact your local Rockwell Automation representative for any technical support issues.

New Product Satisfaction Return

Rockwell tests all of its products to ensure that they are fully operational when shipped from the manufacturing facility. However, if your product is not functioning, it may need to be returned.

United States	Contact your distributor. You must provide a Customer Support case number (see phone number above to obtain one) to your distributor in order to complete the return process.
Outside United States	Please contact your local Rockwell Automation representative for return procedure.

www.rockwellautomation.com

Power, Control and Information Solutions Headquarters

Americas: Rockwell Automation, 1201 South Second Street, Milwaukee, WI 53204-2496 USA, Tel: (1) 414.382.2000, Fax: (1) 414.382.4444

Europe/Middle East/Africa: Rockwell Automation, Vorstlaan/Boulevard du Souverain 36, 1170 Brussels, Belgium, Tel: (32) 2 663 0600, Fax: (32) 2 663 0640

Asia Pacific: Rockwell Automation, Level 14, Core F, Cyberport 3, 100 Cyberport Road, Hong Kong, Tel: (852) 2887 4788, Fax: (852) 2508 1846

Publication 1746-UM008B-EN-P - December 2006

Supersedes Publication 1746-6.7 - June 1998

Copyright © 2006 Rockwell Automation, Inc. All rights reserved. Printed in the U.S.A.