



Digital Energy
Multilin

745 Transformer Protection System Instruction Manual



745 revision: 5.20

Manual Part Number: 1601-0161-A9

GE publication code: GEK-106635H

Copyright © 2011 GE Multilin

GE Multilin

215 Anderson Avenue, Markham, Ontario

Canada L6E 1B3

Tel: (905) 294-6222 Fax: (905) 201-2098

Internet: <http://www.GEmultilin.com>



GE Multilin's Quality Management System is registered to ISO9001:2000

QMI # 005094
UL # A3775

© 2011 GE Multilin Incorporated. All rights reserved.

GE Multilin 745 Transformer Protection System instruction manual for revision 5.20.

745 Transformer Protection System, EnerVista, EnerVista Launchpad, EnerVista 745 Setup, and FlexLogic are registered trademarks of GE Multilin Inc.

The contents of this manual are the property of GE Multilin Inc. This documentation is furnished on license and may not be reproduced in whole or in part without the permission of GE Multilin. The content of this manual is for informational use only and is subject to change without notice.

Part numbers contained in this manual are subject to change without notice, and should therefore be verified by GE Multilin before ordering.

Part number: 1601-0161-A9 (July 2011)

Table of Contents

1: GETTING STARTED	IMPORTANT PROCEDURES	1-1
	CAUTIONS AND WARNINGS	1-1
	INSPECTION CHECKLIST	1-1
	MANUAL ORGANIZATION	1-2
	USING THE RELAY	1-3
	MENU NAVIGATION	1-3
	PANEL KEYING EXAMPLE	1-5
	CHANGING SETPOINTS	1-6
	INTRODUCTION	1-6
	USING THE HELP KEY	1-6
	NUMERICAL SETPOINTS	1-6
	ENUMERATION SETPOINTS	1-7
	TEXT SETPOINTS	1-7
	SECURITY	1-9
	INSTALLATION	1-9
	CHANGING THE PASSCODE	1-9
	DISABLING AND ENABLING PASSCODE SECURITY	1-10

2: OVERVIEW	INTRODUCTION	2-1
	DESCRIPTION	2-1
	PROTECTION FEATURES	2-2
	ORDER CODES	2-3
	SPECIFICATIONS	2-5
	APPLICABILITY	2-5
	INPUTS	2-5
	PROTECTION ELEMENTS	2-6
	OUTPUTS	2-9
	MISCELLANEOUS	2-10

3: INSTALLATION	DRAWOUT CASE	3-1
	CASE DESCRIPTION	3-1
	PANEL CUTOUT	3-2
	CASE MOUNTING	3-2
	UNIT WITHDRAWAL AND INSERTION	3-3
	ETHERNET CONNECTION	3-6
	TYPICAL WIRING	3-7
	DESCRIPTION	3-7
	REAR TERMINAL LAYOUT	3-7
	WIRING DIAGRAMS	3-10
	PHASE SEQUENCE AND TRANSFORMER POLARITY	3-12
	CURRENT TRANSFORMER INPUTS	3-12
	AC VOLTAGE INPUT	3-14
	LOGIC INPUTS	3-14
	CONTROL POWER	3-15
	ANALOG INPUT	3-16
	TAP POSITION INPUT	3-16

RTD DRIVER/SENSOR 3-16
 OUTPUT RELAYS 3-16
 SOLID STATE TRIP OUTPUT 3-17
 ANALOG OUTPUTS 3-17
 RS485/RS422 COMMUNICATIONS 3-17
 RS232 FRONT PANEL PROGRAM PORT 3-19
 IRIG-B 3-20
 DIELECTRIC STRENGTH 3-20

4: INTERFACES

HARDWARE INTERFACE 4-1
 FRONT PANEL 4-1
 DISPLAY 4-2
 LEDs 4-2
 LED INDICATORS 4-2
 PROGRAM PORT 4-4
 KEYPAD 4-4
 SETPOINT ENTRY 4-5
 DIAGNOSTIC MESSAGES 4-7
 FLASH MESSAGES 4-7
ENERVISTA SOFTWARE INTERFACE 4-8
 OVERVIEW 4-8
 HARDWARE 4-8
 INSTALLING THE ENERVISTA 745 SETUP SOFTWARE 4-10
CONNECTING ENERVISTA 745 SETUP TO THE RELAY 4-13
 CONFIGURING SERIAL COMMUNICATIONS 4-13
 USING THE QUICK CONNECT FEATURE 4-15
 CONFIGURING ETHERNET COMMUNICATIONS 4-15
 CONNECTING TO THE RELAY 4-17
WORKING WITH SETPOINTS AND SETPOINT FILES 4-19
 ENGAGING A DEVICE 4-19
 ENTERING SETPOINTS 4-19
 FILE SUPPORT 4-21
 USING SETPOINTS FILES 4-21
UPGRADING RELAY FIRMWARE 4-27
 DESCRIPTION 4-27
 SAVING SETPOINTS TO A FILE 4-27
 LOADING NEW FIRMWARE 4-27
ADVANCED ENERVISTA 745 SETUP FEATURES 4-30
 TRIGGERED EVENTS 4-30
 WAVEFORM CAPTURE (TRACE MEMORY) 4-30
 TRENDING (DATA LOGGER) 4-32
 EVENT RECORDER 4-35
 MODBUS USER MAP 4-36
 VIEWING ACTUAL VALUES 4-37
USING ENERVISTA VIEWPOINT WITH THE 745 4-40
 PLUG AND PLAY EXAMPLE 4-40

5: SETPOINTS

OVERVIEW 5-1
 SETPOINT MESSAGE MAP 5-1
 SETPOINT ENTRY 5-4
 SETPOINT WRITE ACCESS 5-4
AUTO-CONFIGURATION 5-6

INTRODUCTION	5-6
DYNAMIC CT RATIO MISMATCH CORRECTION	5-6
PHASE SHIFTS ON THREE-PHASE TRANSFORMERS	5-8
PHASE ANGLE CORRECTION	5-10
ZERO-SEQUENCE COMPONENT REMOVAL	5-11
TRANSFORMER TYPES	5-13
PHASE SHIFTS	5-24
S1 745 SETUP	5-25
PASSCODE	5-25
PREFERENCES	5-25
COMMUNICATIONS	5-26
RESETTING	5-29
CLOCK	5-29
DEFAULT MESSAGES	5-30
SCRATCHPAD	5-31
INSTALLATION	5-31
UPGRADE OPTIONS	5-31
SETUP EVENT RECORDER	5-33
S2 SYSTEM SETUP	5-34
DESCRIPTION	5-34
TRANSFORMER	5-34
WINDINGS 1 TO 3	5-36
ONLOAD TAP CHANGER	5-37
HARMONICS	5-38
FLEXCURVES™	5-38
VOLTAGE INPUT	5-39
AMBIENT TEMPERATURE	5-39
ANALOG INPUT	5-41
DEMAND METERING	5-41
ANALOG OUTPUTS 1 TO 7	5-43
S3 LOGIC INPUTS	5-44
DESCRIPTION	5-44
LOGIC INPUTS 1 TO 16	5-44
VIRTUAL INPUTS 1 TO 16	5-45
S4 ELEMENTS	5-46
INTRODUCTION TO ELEMENTS	5-46
SETPOINT GROUP	5-47
DIFFERENTIAL ELEMENT	5-48
INSTANTANEOUS DIFFERENTIAL	5-57
PHASE OVERCURRENT	5-58
NEUTRAL OVERCURRENT	5-66
GROUND OVERCURRENT	5-69
RESTRICTED GROUND FAULT	5-72
NEGATIVE SEQUENCE OVERCURRENT	5-76
FREQUENCY	5-78
OVEREXCITATION	5-83
HARMONICS	5-88
INSULATION AGING	5-90
ANALOG INPUT LEVEL	5-94
CURRENT DEMAND	5-95
TRANSFORMER OVERLOAD	5-96
TAP CHANGER FAILURE	5-97

S5 OUTPUTS 5-99

- DESCRIPTION 5-99
- RELAY ASSIGNMENTS 5-99
- INTRODUCTION TO FLEXLOGIC™ 5-99
- FLEXLOGIC™ RULES 5-100
- OUTPUT RELAYS 5-102
- TRACE MEMORY 5-105
- VIRTUAL OUTPUTS 5-106
- TIMERS 5-106

S6 TESTING 5-107

- DESCRIPTION 5-107
- OUTPUT RELAYS 5-107
- ANALOG OUTPUTS 5-108
- SIMULATION 5-108
- FACTORY SERVICE 5-112

6: ACTUAL VALUES

OVERVIEW 6-1

- MESSAGE MAP 6-1
- DESCRIPTION 6-3

A1 STATUS 6-4

- NETWORK STATUS 6-4
- DATE AND TIME 6-4
- LOGIC INPUTS 6-4
- VIRTUAL INPUTS 6-5
- OUTPUT RELAYS 6-5
- VIRTUAL OUTPUTS 6-5
- SELF-TEST ERRORS 6-6

A2 METERING 6-7

- CURRENT 6-7
- HARMONIC CONTENT 6-10
- FREQUENCY 6-12
- TAP CHANGER 6-12
- VOLTAGE 6-12
- DEMAND 6-13
- AMBIENT TEMPERATURE 6-14
- LOSS OF LIFE 6-14
- ANALOG INPUT 6-15
- POWER 6-15
- ENERGY 6-15

A3 EVENT RECORDER 6-17

- EVENT DATA CLEAR 6-17
- EVENT RECORDS 6-17

A4 PRODUCT INFORMATION 6-21

- TECHNICAL SUPPORT 6-21
- REVISION CODES 6-21
- CALIBRATION 6-22

TARGET AND FLASH MESSAGES 6-23

- TARGET MESSAGES 6-23
- SELF-TEST ERRORS 6-25
- FLASH MESSAGES 6-27

7: COMMISSIONING	GENERAL	7-1
	INTRODUCTION	7-1
	TESTING PHILOSOPHY	7-2
	SAFETY PRECAUTIONS	7-2
	CONVENTIONS	7-2
	TEST EQUIPMENT	7-3
	PRELIMINARY WORK	7-5
	DESCRIPTION	7-5
	DIELECTRIC STRENGTH TESTING	7-6
	LOGIC INPUTS AND OUTPUT RELAYS	7-7
	LOGIC INPUTS	7-7
	OUTPUT RELAYS	7-8
	METERING	7-9
	DESCRIPTION	7-9
	CURRENT INPUTS	7-9
	VOLTAGE INPUT	7-10
	TRANSFORMER TYPE SELECTION	7-11
	AMBIENT TEMPERATURE INPUT	7-13
	ANALOG OUTPUTS	7-14
	TAP POSITION	7-15
	PROTECTION SCHEMES	7-16
	PRECAUTION	7-16
	HARMONIC RESTRAINED PERCENT DIFFERENTIAL	7-16
	INSTANTANEOUS DIFFERENTIAL PROTECTION	7-23
	PHASE TIME OVERCURRENT	7-25
	PHASE INSTANTANEOUS OVERCURRENT 1	7-27
	PHASE INSTANTANEOUS OVERCURRENT 2	7-28
	NEUTRAL TIME OVERCURRENT	7-29
	NEUTRAL INSTANTANEOUS OVERCURRENT 1	7-31
	NEUTRAL INSTANTANEOUS OVERCURRENT 2	7-32
	GROUND TIME OVERCURRENT	7-32
	GROUND INSTANTANEOUS OVERCURRENT 1	7-35
	GROUND INSTANTANEOUS OVERCURRENT 2	7-36
	RESTRICTED GROUND FAULT POLARITY TEST	7-36
	RESTRICTED GROUND FAULT ELEMENT TEST	7-37
	NEGATIVE-SEQUENCE TIME OVERCURRENT	7-39
	NEGATIVE-SEQUENCE INSTANTANEOUS OVERCURRENT	7-42
	FREQUENCY	7-43
	OVEREXCITATION	7-52
	INSULATION AGING	7-54
	TAP MONITOR FAILURE	7-55
	AUXILIARY PROTECTION AND MONITORING FUNCTIONS	7-56
	THD LEVEL SCHEME	7-56
	HARMONIC DERATING FUNCTION	7-57
	TRANSFORMER OVERLOAD	7-58
	PLACING THE RELAY INTO SERVICE	7-60
	PRECAUTIONS	7-60
	PROCEDURE	7-60

APPENDIX	CHANGE NOTES	A-1
	REVISION HISTORY	A-1
	CHANGES TO THE 745 MANUAL	A-1
	EU DECLARATION OF CONFORMITY	A-4
	EU DECLARATION	A-4
	GE MULTILIN WARRANTY	A-5
	WARRANTY STATEMENT	A-5

INDEX



745 Transformer Protection System

Chapter 1: Getting Started

1.1 Important Procedures

1.1.1 Cautions and Warnings

Please read this chapter to guide you through the initial setup of your new relay.



Before attempting to install or use the relay, it is imperative that all WARNINGS and CAUTIONS in this manual are reviewed to help prevent personal injury, equipment damage, and/or downtime.

1.1.2 Inspection Checklist

- Open the relay packaging and inspect the unit for physical damage.
- View the rear nameplate and verify that the correct model has been ordered.
- Ensure that the following items are included:
 - Instruction manual
 - GE EnerVista CD (includes software and relay documentation)
 - Mounting screws
- For product information, instruction manual updates, and the latest software updates, please visit the GE Multilin website at <http://www.GEmultilin.com>



If there is any noticeable physical damage, or any of the contents listed are missing, please contact GE Multilin immediately.

1.1.3 Manual Organization

Reading a lengthy instruction manual on a new product is not a task most people enjoy. To speed things up, this introductory chapter provides guidelines for basic relay usability. Important wiring considerations and precautions discussed in *Typical Wiring* on page 3–7 should be observed for reliable operation. Detailed information regarding accuracy, output relay contact ratings, and so forth are detailed in *Specifications* on page 2–5. The remainder of this manual should be read and kept for reference to ensure maximum benefit from the 745 Transformer Protection System. For further information, please consult your local sales representative or the factory. Comments about new features or modifications for your specific requirements are welcome and encouraged.

Setpoints and actual values are indicated as follows in the manual:

A2 METERING ▷▽ LOSS OF LIFE ▷ HOTTEST-SPOT WINDING TEMPERATURE

This 'path representation' illustrates the location of a specific actual value or setpoint with regards to its previous menus and sub-menus. In the example above, the **HOTTEST-SPOT WINDING TEMPERATURE** actual value is shown to be an item in the **LOSS OF LIFE** sub-menu, which itself is an item in the **A2 METERING** menu, which is an item of **ACTUAL VALUES**.

Sub-menu levels are entered by pressing the MESSAGE RIGHT or ENTER keys. When inside a submenu, the MESSAGE LEFT or ESCAPE key returns to the previous sub-menu. The MESSAGE UP and DOWN keys are used to scroll through the settings in a sub-menu. The display indicates which keys can be used at any given point.

1.2 Using the Relay

1.2.1 Menu Navigation

Press the MENU key to access the header of each menu, which will be displayed in the following sequence:

```
■ SETPOINTS [▷]
```

```
■ ACTUAL VALUES [▷]
```

```
■ TARGET MESSAGES [▷]
```

To access setpoints, press the MENU key until the display shows the header of the setpoints menu, and then press the MESSAGE RIGHT or ENTER key to display the header for the first setpoints page. The setpoint pages are numbered, have an 'S' prefix for easy identification and have a name which provides a general idea of the settings available in that page. Pressing the MESSAGE UP and DOWN keys will scroll through all the available setpoint page headers. Setpoint page headers look as follows:

```
■ SETPOINTS [▷]
S1 745 SETUP
```

To enter a given setpoints page, press the MESSAGE RIGHT or ENTER key. Press the MESSAGE UP or DOWN keys to scroll through sub-page headers until the required message is reached. The end of a page is indicated by the message **END OF PAGE**. The beginning of a page is indicated by the message **TOP OF PAGE**.

To access actual values, press the MENU key until the display shows the header of the actual values menu, then press the MESSAGE RIGHT or ENTER key to display the header for the first actual values page. The actual values pages are numbered, have an 'A' prefix for easy identification and have a name, which gives a general idea of the information available in that page. Pressing the MESSAGE UP or DOWN keys will scroll through all the available actual values page headers. Actual values page headers look as follows:

```
■ ACTUAL VALUES [▷]
A1 STATUS
```

To enter a given actual values page, press the MESSAGE RIGHT or ENTER key. Press the MESSAGE UP or DOWN keys to scroll through sub-page headers until the required message is reached. The end of a page is indicated by the message **END OF PAGE**. The beginning of a page is indicated by the message **TOP OF PAGE**.

Similarly, to access additional sub-pages, press the MESSAGE RIGHT or ENTER key to enter the first sub-page, and then the MESSAGE UP or DOWN keys to scroll through the available sub-pages, until the desired message is reached. The process is identical for both setpoints and actual values.

The following procedure illustrates the key sequence to access the Current Demand actual values.

1. Press the MENU key until you reach the actual values main menu.

```

■ ACTUAL VALUES [▷]
    
```

2. Press MESSAGE RIGHT or ENTER key to enter the first actual values page, and then the MESSAGE UP or DOWN key to scroll through pages, until the **A2 METERING DATA** page appears.

```

■ ACTUAL VALUES [▷]
A2 METERING DATA
    
```

3. Press the MESSAGE RIGHT or ENTER key to display the first sub-page heading for the Metering Data actual values page:

```

■ CURRENT [▷]
METERING
    
```

Pressing the MESSAGE UP or DOWN keys will scroll the display up and down through the sub-page headers. Pressing the MESSAGE LEFT or ESCAPE key at any sub-page heading will return the display to the heading of the corresponding setpoint or actual value page, and pressing it again, will return the display to the main menu header.

4. Press the MESSAGE DOWN key until the **ZERO SEQUENCE CURRENT METERING** sub-page heading appears.

```

■ ZERO SEQUENCE [▷]
CURRENT METERING
    
```

5. At this point, pressing MESSAGE RIGHT or ENTER key will display the messages under this sub-page. If instead you press the MESSAGE UP key, it will return to the previous sub-page heading. In this case,

```

■ POS. SEQUENCE [▷]
CURRENT METERING
    
```

6. When the symbols ■ and ▷ appear on the top line, it indicates that additional sub-pages are available and can be accessed by pressing the MESSAGE RIGHT or ENTER key. Pressing MESSAGE RIGHT or ENTER while at the zero-sequence current metering sub-page heading displays the following:

```

W1 NEG SEQ CURRENT:
0 A at 0° Lag
    
```

Pressing the MESSAGE LEFT key returns to the zero-sequence current metering sub-page heading.

7. Press the MESSAGE DOWN key to display the next actual value of this sub-page. Actual values and setpoints messages always have a colon separating the name of the value and the actual value or setpoint. This particular message displays the current demand as measured by the relay.

The menu path to the value shown above is indicated as **A2 METERING DATA ▷ ▽ ZERO SEQUENCE CURRENT METERING ▷ W1 NEG SEQ CURRENT**. Setpoints and actual values messages are referred to in this manner throughout the manual.

1.2.2 Panel Keying Example

For example, the **S4 ELEMENTS** ▷ ▽ **INSULATION AGING** ▷ ▽ **AGING FACTOR LIMIT** ▷ ▽ **AGING FACTOR LIMIT PICKUP** path representation describes the following key-press sequence:

1. Press the MENU key until the setpoints header appears on the display.

```
■ SETPOINTS  [▷]
```

2. Press the MESSAGE RIGHT or ENTER key, and then the MESSAGE DOWN key until the **S4 ELEMENTS** message is displayed.

```
■ SETPOINTS  [▷]
S4 ELEMENTS
```

3. Press the MESSAGE RIGHT or ENTER key to display **INSULATION AGING** message.

```
■ INSULATION [▷]
AGING
```

4. Press the MESSAGE RIGHT or ENTER key to display **AGING FACTOR LIMIT** message.

```
■ AGING FACTOR [▷]
LIMIT
```

5. Press the MESSAGE RIGHT or ENTER key to reach the **AGING FACTOR LIMIT PICKUP** message and the corresponding setpoint value.

```
AGING FACTOR LIMIT
PICKUP: 2.0
```

6. Press the MESSAGE DOWN key to display the next actual value message as shown below:

```
AGING FACTOR LIMIT
DELAY: 10 min.
```

7. Pressing the MESSAGE UP or DOWN keys scrolls the display up and down through all the setpoint displays in this corresponding sub-page.
8. Pressing the MESSAGE LEFT key reverses the process described above and returns the display to the previous level.

```
■ AGING FACTOR [▷]
LIMIT
```

9. Press the MESSAGE LEFT key twice to return to the **S4 ELEMENTS** page header.

```
■ SETPOINTS  [▷]
S4 ELEMENTS
```

1.3 Changing Setpoints

1.3.1 Introduction

There are several different classes of setpoints, distinguished by the way their values are displayed and edited. This section describes how to edit the values used by all setpoint classes.

Hardware and passcode security features are designed to provide protection against unauthorized setpoint changes. Since we will be programming new setpoints using the front panel keys, a hardware jumper must be installed across the setpoint access terminals (D9 and D10) on the back of the relay case. A keyswitch may also be used across these terminals to enable setpoint access. Attempts to enter a new setpoint via the front panel without this connection will be unsuccessful.

1.3.2 Using the HELP Key

Each numerical setpoint has its own minimum, maximum, and increment value associated with it. These parameters define what values are acceptable for a setpoint.

1. Select the **S2 SYSTEM SETUP ▷ ▾ VOLTAGE INPUT ▷ ▾ NOMINAL VT SECONDARY VOLTAGE** setpoint.

NOMINAL VT SECONDARY VOLTAGE: 120.0 V
--

2. Press HELP. The following context sensitive flash message will appear for several seconds. For the case of a numerical setpoint message, the HELP key displays the minimum, maximum, and step value.

Range: 60.0 to 120.0 by 0.1
--

1.3.3 Numerical Setpoints

The following two methods of editing and storing a numerical setpoint value are available.

1. **0 to 9 and the decimal key:** The relay numeric keypad works the same as that of any electronic calculator. A number is entered one digit at a time. The left-most digit is entered first and the right-most digit is entered last. Pressing the ESCAPE key, before the ENTER key, returns the original value to the display.
2. **VALUE keys:** The VALUE UP key increments the displayed value, by the step value, up to the maximum value allowed. While at the maximum, pressing the VALUE UP key again will allow setpoint selection to continue from the minimum value. The VALUE DOWN key decrements the displayed value, by the step value, down to the minimum value. Again, continuing to press the VALUE DOWN key while at the minimum value will continue setpoint selection from the maximum value.

As an example, let's set the nominal VT secondary voltage setpoint to 69.3 V. Press the appropriate numeric keys in the sequence '6 9 . 3'. The display message will change as the digits are being entered.

**NOMINAL VT SECONDARY
VOLTAGE: 69.3 V**

Editing changes are not registered until the ENTER key is pressed. Press the ENTER key to store the new value in memory. This flash message momentarily appears to confirmation the storing process. If 69.28 were entered, the value is automatically rounded to 69.3, since the step value for this setpoint is 0.1.

**NEW SETPOINT HAS
BEEN STORED**

1.3.4 Enumeration Setpoints

Enumeration setpoints have data values which are part of a set, whose members are explicitly defined by a name. A set is comprised of two or more members.

Enumeration type values are changed using the VALUE keys. The VALUE UP key displays the next selection while the VALUE DOWN key displays the previous selection. As an example we may need to set the phase sequence to ACB. Press the VALUE keys until the proper selection is displayed.

**PHASE SEQUENCE:
ACB**

Editing changes are not registered until ENTER is pressed, storing the new value in memory. This flash message momentarily appears to confirm the storing process.

**NEW SETPOINT HAS
BEEN STORED**

1.3.5 Text Setpoints

Text setpoints have data values which are fixed in length, but user defined in character. They may be comprised of upper case letters, lower case letters, numerals, and a selection of special characters.

The editing and storing of a text value is accomplished with the use of the decimal, ENTER, VALUE, and ESCAPE keys. For example:

1. The name for output relay 3 should be more descriptive than the default value. For this example let us rename output relay as **INST DIFF TRIP**. Press the decimal key and an underscore (_) will appear at the first character position.

**OUTPUT 3 NAME:
_ Trip 3**

2. Press VALUE keys until the character "I" is displayed in the first position, then press the decimal key to store the character and advance the cursor. Change the second character to a "N" using the VALUE keys and save this change by pressing the decimal key again. Continue editing all the characters in the text until the string **INST DIFF TRIP** is entered. Note that a space is selected like a character. If a character is entered

incorrectly, press the decimal key repeatedly until the cursor returns to the position of the error and re-enter the character as required. Once complete, press ENTER to remove the solid cursor and save the result.

OUTPUT 3 NAME: INST DIFF TRIP
--

1.4 Security

1.4.1 Installation

Note that the relay is defaulted to the “Not Programmed” state before it leaves the factory. This safeguards against the installation of a relay whose setpoints have not been entered. In addition, a relay in the “Not Programmed” state blocks signaling of any output relay, and turns off the In Service LED indicator.

Move to the **S1 745 SETUP ▷ ▽ INSTALLATION ▷ ▽ 745 SETPOINTS** message. To put the relay in the “Programmed” state, press the VALUE UP or DOWN key once and press ENTER. Enter “Yes” for the **ARE YOU SURE?** message. The In Service LED indicator will now turn on.

745 SETPOINTS:
Not Programmed

1.4.2 Changing the Passcode

To guarantee that the relay settings cannot be tampered with, the user may setup the passcode security feature.

1. Move to the **S1 745 SETUP ▷ PASSCODE ▷ SETPOINT ACCESS** message. This message cannot be edited directly. It simply indicates whether passcode security is enabled (**SETPOINT ACCESS: “Read Only”**), or passcode security is disabled (**SETPOINT ACCESS: “Read & Write”**). Each relay is shipped from the factory with setpoint access allowed. The passcode is also defaulted to '0', which disables the passcode security feature entirely.

SETPOINT ACCESS:
Read & Write

2. Press the MESSAGE DOWN key once.

CHANGE PASSCODE?
No

3. Press the VALUE UP or VALUE DOWN key once.

CHANGE PASSCODE?
Yes

4. Press the ENTER key to begin the procedure of changing the passcode. The displayed message will change as shown. The current passcode is '0', so press the '0' numeric key. The relay will acknowledge the key press by displaying ‘*’.

**PLEASE ENTER CURRENT
PASSCODE:**

5. Press the ENTER key.

**ENTER NEW PASSCODE
FOR ACCESS:**

- For this example, change the passcode to “123” by pressing the appropriate numeric keys in the ‘1 2 3’ sequence. The message will change as the digits are entered, with the end result being as shown.

**ENTER NEW PASSCODE
FOR ACCESS: *****

- Press the ENTER key to store the new passcode and a confirmation message appears. As a safety measure, the relay requires you to enter a new passcode twice. This ensures the passcode has been entered correctly.

**PLEASE RE-ENTER NEW
PASSCODE:**

- After pressing the appropriate numeric keys in the sequence ‘1 2 3’, press ENTER. This flash message appears momentarily on the display and confirms the new passcode is stored in memory.

**NEW PASSCODE
HAS BEEN STORED**

- After a few seconds, the original display returns.
- Press the MESSAGE UP key. As soon as a non-zero passcode is entered, setpoint access will automatically become restricted.

**ALLOW ACCESS TO
SETPOINTS? No**

1.4.3 Disabling and Enabling Passcode Security

Suppose at some time in the future you want to alter a setpoint. In order to do this, you must first disable passcode security, make the setpoint change, and then re-enable the passcode security.

- Move to message [S1 745 SETUP ▷ PASSCODE ▷ ▽ ALLOW ACCESS TO SETPOINTS](#). It is from here that we will disable passcode security. Please note that this message is hidden, when the passcode security feature is disabled by entering a passcode of “0”.

**ALLOW ACCESS TO
SETPOINTS? No**

- Press the VALUE UP or DOWN key once to select “Yes” and press ENTER. The displayed message will change as shown.

**PLEASE ENTER CURRENT
PASSCODE:**

- Enter the current passcode and press the ENTER key. This flash message indicates that the keyed in value was accepted and that passcode security is now disabled.

**SETPOINT ACCESS
IS NOW ALLOWED**

- This message will appear after a few seconds. Now that setpoint access is enabled, the **ALLOW ACCESS TO SETPOINTS** message has been replaced by the **RESTRICT ACCESS TO SETPOINTS** message. The relay's setpoints can now be altered and stored. If no front panel keys are pressed for longer than 30 minutes, setpoint access will automatically become restricted again.

**RESTRICT ACCESS TO
SETPOINTS? No**

- To disable setpoint access, immediately after setpoint editing, move back to message **S1 745 SETUP ▷ PASSCODE ▷ ▽ RESTRICT ACCESS TO SETPOINTS** and enter "Yes". Key the current passcode into the shown message.

**PLEASE ENTER CURRENT
PASSCODE:**

- Press the ENTER key and this message will flash on the display. It indicates that passcode security is now enabled.

**SETPOINT ACCESS
IS NOW RESTRICTED**

- After a few seconds, the original display returns.



745 Transformer Protection System

Chapter 2: Overview

2.1 Introduction

2.1.1 Description

These instructions do not purport to cover all details or variations in equipment nor provide for every possible contingency to be met in connection with installation, operation, or maintenance. Should further information be desired or should particular problems arise which are not covered sufficiently for the purchaser's purpose, the matter should be referred to the General Electric company.

To the extent required the products described herein meet applicable ANSI, IEEE, and NEMA standards; but no such assurance is given with respect to local codes and ordinances because they vary greatly.

The 745 Transformer Protection System™ is a high speed, multi-processor based, three-phase, two or three winding, transformer management relay intended for the primary protection and management of small, medium and large power transformers. The 745 combines percent differential, overcurrent, frequency, and overexcitation protection elements along with monitoring of individual harmonics, and total harmonic distortion (THD) in one economical package.

The relay provides a variety of adaptive relaying features:

- Adaptive harmonic restraint which addresses the problem of false tripping during inrush
- Adaptive time overcurrent elements which will adjust their pickup settings based on the calculated transformer capability when supplying load currents with high harmonic content
- Multiple setpoint groups which allow the user to enter and dynamically select from up to four groups of relay settings to address the protection requirements of different power system configurations

- Dynamic CT ratio mismatch correction which monitors the on-load tap position and automatically corrects for CT ratio mismatch
- FlexLogic™ which allows PLC style equations based on logic inputs and protection elements to be assigned to any of the 745 outputs.

The 745 also includes a powerful testing and simulation feature. This allows the protection engineer the ability to test the relay operation based on captured or computer generated waveform data which can be converted to a digitized format and downloaded into the 745's simulation buffer for "playback". A waveform capture function that records waveform data for fault, inrush, or alarm conditions is also provided.

The auto-configuration function eliminates the need for any special CT connections by having all CTs connected in wye.

2.1.2 Protection Features

The following table outlines the protection features available for windings 1, 2, and 3, as well as the common protection elements.

Symbol	Common protection element
59/81-1	Volts-per-hertz 1
59/81-2	Volts-per-hertz 2
81U-1	Underfrequency 1
81U-2	Underfrequency 2
81U-R1	Frequency decay rate 1
81U-R2	Frequency decay rate 2
81U-R3	Frequency decay rate 3
81U-R4	Frequency decay rate 4
81-H5	5th harmonic Level
81O	Overfrequency
87	Differential (percent)
50/87	Instantaneous differential
AN-1	Analog input level 1
AN-2	Analog input level 2
---	Insulation aging: aging factor, hottest spot limit, and total accumulated life
---	Tap changer monitor

Symbol	Winding 1 protection elements
150/46	Negative sequence instantaneous overcurrent
151/46	Negative sequence time overcurrent
150P1	Phase instantaneous overcurrent 1
150P2	Phase instantaneous overcurrent 2
150N1	Neutral (3I ₀) instantaneous overcurrent 1
150N2	Neutral (3I ₀) instantaneous overcurrent 2
150G1	Ground instantaneous overcurrent 1
150G2	Ground instantaneous overcurrent 2
151P	Phase time overcurrent
151N	Neutral (3I ₀) time overcurrent
151G	Ground time overcurrent
187TG	Ground differential (restricted ground fault)
1THD	Total harmonic distortion level
1AD	Current demand

Symbol	Winding 2 protection elements
250/46	Negative sequence instantaneous overcurrent
251/46	Negative sequence time overcurrent
250P1	Phase instantaneous overcurrent 1
250P2	Phase instantaneous overcurrent 2
250N1	Neutral (3I ₀) instantaneous overcurrent 1
250N2	Neutral (3I ₀) instantaneous overcurrent 2
250G1	Ground instantaneous overcurrent 1
250G2	Ground instantaneous overcurrent 2
251P	Phase time overcurrent
251N	Neutral (3I ₀) time overcurrent
251G	Ground time overcurrent
287TG	Ground differential (restricted ground fault)
2THD	Total harmonic distortion level
2AD	Current demand

Symbol	Winding 3 protection elements
350/46	Negative sequence instantaneous overcurrent
351/46	Negative sequence time overcurrent
350P1	Phase instantaneous overcurrent 1
350P2	Phase instantaneous overcurrent 2
350N1	Neutral (3I ₀) instantaneous overcurrent 1
350N2	Neutral (3I ₀) instantaneous overcurrent 2
351P	Phase time overcurrent
351N	Neutral (3I ₀) time overcurrent
351G	Ground time overcurrent
387TG	Ground differential (restricted ground fault)
3THD	Total harmonic distortion level
3AD	Current demand

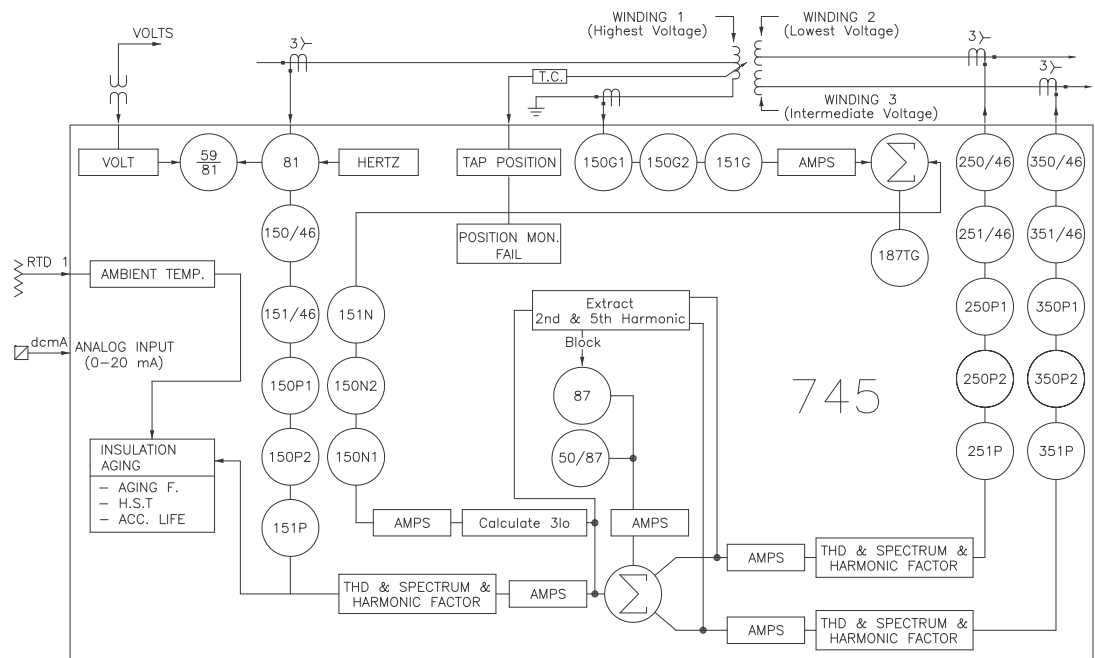

FIGURE 2-1: Single line diagram

2.1.3 Order Codes

The order codes for the 745 Transformer Protection System are shown below.

Table 2-1: 745 order codes

	745	-	*	-	*	-	*	-	*	-	*	-	*
Base unit	745												745 Transformer Protection System
Windings per phase	W2												Two windings per phase
	W3												Three windings per phase
Phase current input ratings	P1												Winding 1 = 1 A, Winding 2 = 1 A, Winding 3 = 1 A
	P5												Winding 1 = 5 A, Winding 2 = 5 A, Winding 3 = 5 A
	P15												Winding 1 = 1 A, Winding 2 = 5 A
	P51												Winding 1 = 5 A, Winding 2 = 1 A
	P115												Winding 1 = 1 A, Winding 2 = 1 A, Winding 3 = 5 A
	P151												Winding 1 = 1 A, Winding 2 = 5 A, Winding 3 = 1 A
	P155												Winding 1 = 1 A, Winding 2 = 5 A, Winding 3 = 5 A
	P511												Winding 1 = 5 A, Winding 2 = 1 A, Winding 3 = 1 A
	P515												Winding 1 = 5 A, Winding 2 = 1 A, Winding 3 = 5 A
	P551												Winding 1 = 5 A, Winding 2 = 5 A, Winding 3 = 1 A
Ground current input ratings	G1												Winding 1/2 = 1 A, Winding 2/3 = 1 A
	G5												Winding 1/2 = 5 A, Winding 2/3 = 5 A
	G15												Winding 1/2 = 1 A, Winding 2/3 = 5 A
	G51												Winding 1/2 = 5 A, Winding 2/3 = 1 A
Control power	LO												20 to 60 V DC; 20 to 48 V AC at 48 to 62 Hz
	HI												90 to 300 V DC; 70 to 265 V AC at 48 to 62 Hz
Options	A												Analog inputs/outputs
	L												Loss of life
	R												Restricted ground fault
Display/Ethernet	B												Basic display
	E												Enhanced display, larger LCD
	T												Enhanced display, larger LCD, with Ethernet (10Base-T)
Harsh environment												H	Harsh (chemical) environment conformal coating

2.2 Specifications

2.2.1 Applicability

TRANSFORMERS AND FREQUENCY

Transformers:	two-winding or three-winding
Frequency:	50 or 60 Hz nominal
Frequency tracking:	40 to 65 Hz for $0.05 \times CT < \text{current} \leq 1 \times CT$ 5 to 65 Hz for current $> 1 \times CT$ 2 to 65 Hz for voltage $> 50\%$ of VT (only if voltage sensing is enabled)

2.2.2 Inputs

CONTROL POWER

Options:	LO/HI (specified when ordering)
LO range:	20 to 60 V DC; 20 to 48 V AC at 48 to 62 Hz
HI range:	90 to 300 V DC; 70 to 265 V AC at 48 to 62 Hz
Power:	30 VA nominal, 40 VA maximum
Total loss of voltage ride-through time (0% control power):	16.7 ms
Fuse current rating:	3.15 A (fuse not accessible)
Fuse type:	5 × 20 mm slow-blow Littelfuse, high breaking capacity; model 2153.15

PHASE CURRENT INPUT

Source CT:	1 to 50000 A primary; 1 or 5 A secondary
Relay input:	1 A or 5 A (specified at order)
Burden:	less than 0.2 VA at rated load per phase
Conversion range:	0.02 to $46 \times CT$ at 50/60 Hz nominal frequency
Accuracy at $< 4 \times CT$:	$\pm 0.25\%$ of $4 \times CT$ ($\pm 0.01 \times CT$) at 50/60 Hz nominal frequency
Accuracy at $\geq 4 \times CT$:	$\pm 0.5\%$ of $46 \times CT$ ($\pm 0.2 \times CT$) at 50/60 Hz nominal frequency
Overload withstand:	1 second at 80 times rated current; 2 seconds at 40 times rated current; continuous at 3 times rated current

GROUND CURRENT INPUT

Source CT:	1 to 50000 A primary, 1 or 5 A secondary
Relay input:	1 A or 5 A (specified at order)
Burden:	less than 0.2 VA at rated load
Conversion range:	0.02 to $46 \times CT$
Accuracy at $< 4 \times CT$:	$\pm 0.25\%$ of $4 \times CT$ ($\pm 0.01 \times CT$)
Accuracy at $\geq 4 \times CT$:	$\pm 0.5\%$ of $46 \times CT$ ($\pm 0.2 \times CT$)
Overload withstand:	1 second at 80 times rated current; 2 seconds at 40 times rated current; continuous at 3 times rated current

VOLTAGE INPUTS

Source VT:	2 to 600 kV / 60 to 120 V
Source VT ratio:	1 to 5000 in steps of 1
Relay input:	60 to 120 V phase-neutral
Burden:	less than 0.025 VA at 120 V
Maximum continuous input:	273 V
Maximum accuracy input:	260 V (full-scale)

Accuracy:..... $\pm 2.0\%$ of full-scale

LOGIC INPUTS

Number of inputs:16
 Dry contacts:1000 Ω maximum ON resistance (32 V DC at 2 mA provided by the 745)
 Wet contacts:30 to 300 V DC at 1.5 mA

ANALOG INPUT

Type:DC mA
 Ranges:.....0 to 1 mA, 0 to 5 mA, 0 to 20 mA, 4 to 20 mA (programmable)
 Input impedance:375 $\Omega \pm 10\%$
 Conversion range:.....0 to 21 mA
 Accuracy:..... $\pm 1\%$ of full scale (based on input range)

TAP POSITION

Type:resistance (ohms)
 Range:.....0 to 500 Ω or 0.5 to 5.0 k Ω
 Bias current:.....1 mA or 10 mA (based on input range)
 Accuracy:..... $\pm 1\%$ of full scale (based on input range)

RTD

Type:3 wire
 RTD Type:.....100 Ω Platinum (DIN.43760), 100 Ω Nickel, 120 Ω Nickel

IRIG-B INPUT

Amplitude-modulated:.....1.0 to 10 V pk-pk
 DC shift:.....TTL
 Input impedance:70 to 100 k Ω

2.2.3 Protection Elements

PERCENT DIFFERENTIAL

Operating current pickup: 0.05 to 1.00 \times CT in steps of 0.01
 Dropout level:97 to 98% of pickup
 Slope 1 range:15% to 100% in steps of 1
 Slope 2 range:50% to 100% in steps of 1
 KP (Slope-1 kneepoint):1.0 to 20.0 \times CT in steps of 0.1
 Harmonic restraint:0.1 to 65.0% in steps of 0.1
 Solid state output operate time:
 pickup < 1 \times CT:42 to 52 ms
 1 \times CT < pickup < 1.1 \times kneepoint: 34 to 44 ms
 pickup > 1.1 \times kneepoint:.....26 to 36 ms
 Relay outputs 2 to 5 operate time:
 pickup < 1 \times CT:.....46 to 56 ms
 1 \times CT < pickup < 1.1 \times kneepoint: 38 to 48 ms
 pickup > 1.1 \times kneepoint:.....30 to 40 ms

INSTANTANEOUS DIFFERENTIAL OVERCURRENT

Pickup level:.....3.00 to 20.00 \times CT in steps of 0.01
 Dropout level:97 to 98% of pickup
 Level accuracy:.....per current input

Solid state output operate time:
 at 1.2 × pickup: 22 to 30 ms
 at 2.0 × pickup: 18 to 26 ms
 at 4.0 × pickup: 11 to 19 ms

Relay outputs 2 to 5 operate time:
 at 1.2 × pickup: 28 to 36 ms
 at 2.0 × pickup: 24 to 32 ms
 at 4.0 × pickup: 17 to 25 ms

PHASE / NEUTRAL / GROUND / NEGATIVE SEQUENCE TIME OVERCURRENT

Pickup level:0.05 to 20.00 × CT in steps of 0.01
 Dropout level:97 to 98% of pickup
 Curve shapes:ANSI extremely/very/moderately/normally inverse;
 definite time (0.1 s base curve); IEC curve A/B/C and short;
 FlexCurve™ A/B/C (programmable curves); IAC extreme/
 very/inverse/short
 Curve multiplier:0.00 to 100.00 in steps of 0.01
 Reset type:instantaneous or linear
 Level accuracy:per current input
 Timing accuracy:±3% of trip time or ±20 ms (whichever is greater) at ≥ 1.03
 × pickup

PHASE / NEUTRAL / GROUND / NEGATIVE SEQUENCE INSTANTANEOUS OVERCURRENT

Pickup level:0.05 to 20.00 × CT in steps of 0.01
 Dropout level:97 to 98% of pickup
 Time delay:0 to 60000 ms in steps of 1
 Level accuracy:per current input
 Solid state output operate time:
 at 1.2 × pickup: 22 to 30 ms
 at 2.0 × pickup: 18 to 26 ms
 at 4.0 × pickup: 11 to 19 ms
 Relay outputs 2 to 5 operate time:
 at 1.2 × pickup: 28 to 36 ms
 at 2.0 × pickup: 24 to 32 ms
 at 4.0 × pickup: 17 to 25 ms

RESTRICTED GROUND FAULT

Number of elements:2
 Minimum pickup:0.02 to 20.00 × CT in steps of 0.01
 Dropout level:97 to 98% of pickup
 Slope range:0 to 100% in steps of 1
 Pickup delay:0.00 to 600.00 s in steps of 0.01
 Solid-state output operating time:
 at 1.1 × pickup: 30 to 50 ms
 at 10 × pickup: 20 to 30 ms
 (delay set at 0.0 s)
 Relay outputs 2 to 5 operating time:
 at 1.1 × pickup: 30 to 50 ms
 at 10 × pickup: 20 to 30 ms
 (delay set at 0.0 s)

UNDERFREQUENCY

Number of elements:2
 Operating current pickup: 0.05 to 1.00 × CT in steps of 0.01
 Operating voltage pickup: 0.10 to 0.99 × VT in steps of 0.01
 Pickup level:45.00 to 59.99 Hz in steps of 0.01
 Dropout level:pickup + 0.03 Hz

Time delay:0.00 to 600.00 s in steps of 0.01
 Signal source:winding 1 phase A current / voltage
 Level accuracy: ± 0.02 Hz
 Solid state output operate time: 39 to 60 ms at 3% beyond pickup (delay set at 0.0 s)
 Relay outputs 2 to 5 operate time: 42 to 66 ms at 3% beyond pickup (delay set at 0.0 s)

FREQUENCY RATE OF CHANGE

Number of elements:4
 Operating current pickup: 0.05 to $1.00 \times CT$ in steps of 0.01
 Operating voltage pickup: 0.10 to $0.99 \times VT$ in steps of 0.01
 Pickup level:45.00 to 59.99 Hz in steps of 0.01
 Dropout level:pickup + 0.03 Hz
 Rate 1/2/3/4:0.1 to 5.0 Hz/sec. in steps of 0.1
 Dropout level:pickup + 0.07 Hz/sec.
 Signal source:winding 1 phase A current / voltage
 Level accuracy: ± 0.02 Hz
 Operate time:The operate time of this element is variable and is dependent on the decay rate setting and the supervision frequency level.

OVERFREQUENCY

Operating current pickup: 0.05 to $1.00 \times CT$ in steps of 0.01
 Operating voltage pickup: 0.10 to $0.99 \times VT$ in steps of 0.01
 Pickup level:50.01 to 65.00 Hz in steps of 0.01
 Dropout level:pickup - 0.03 Hz
 Time delay:0.00 to 600.00 s in steps of 0.01
 Signal source:winding 1 phase A current / voltage
 Level accuracy: ± 0.02 Hz
 Solid state output operate time: 39 to 60 ms at 3% beyond pickup (delay set at 0.0 s)
 Relay outputs 2 to 5 operate time: 42 to 66 ms at 3% beyond pickup (delay set at 0.0 s)

OVEREXCITATION ON VOLTS PER HERTZ

Number of elements:2
 Operating voltage pickup: 0.10 to $0.99 \times VT$ in steps of 0.01
 Pickup level:1.00 to 4.00 V/Hz in steps of 0.01
 Curve shapes:definite time (0.1 second base curve); IEC curve A/B/C
 Time delay:0.00 to 600.00 s in steps of 0.01
 Reset delay:0.0 to 6000.0 s in steps of 0.1
 Signal source:voltage
 Range:10 to 65 Hz
 Level accuracy: ± 0.02 V/Hz
 Solid state output operate time: 165 to 195 ms at $1.10 \times$ pickup
 Relay outputs 2 to 5 operate time: 170 to 200 ms (delay set at 0.0 s) at $1.10 \times$ pickup

OVEREXCITATION ON FIFTH HARMONIC LEVEL

Operating current pickup: 0.03 to $1.00 \times CT$ in steps of 0.01
 Pickup level:0.1 to 99.9 in steps of 0.1%
 Dropout:95% of pickup
 Time delay:0 to 60000 s in steps of 1 s
 Signal source:all phase currents
 Solid state output operate time: 20 to 120 ms at $1.10 \times$ pickup
 Relay outputs 2 to 5 operate time: 25 to 125 ms (delay set at 0.0 s) at $1.10 \times$ pickup

INSULATION AGING

Hottest spot limit:

Pickup level: 50 to 300°C in steps of 1

Delay: 0 to 60000 min. in steps of 1

Aging factor limit:

Pickup level: 1.1 to 10.0 in steps of 0.1

Delay: 0 to 60000 min. in steps of 1

Loss of life limit:

Pickup level: 0 to 20000 × 10 h in steps of 1

2.2.4 Outputs**ANALOG OUTPUTS**

Number of outputs: 7

Output range: 0 to 1 mA, 0 to 5 mA, 0 to 10 mA, 0 to 20 mA, or 4 to 20 mA

Maximum load: 10 kΩ at 0 to 1 mA
600 Ω at 4 to 20 mA

Isolation: fully isolated

Accuracy: ±1% of full scale

SOLID STATE OUTPUT

Maximum ratings: make and carry 15 A at 250 V DC for 500 ms

TRIP RELAYS 2 TO 5

Configuration: form-A (breaker trip rated)

Contact material: silver alloy

Max. ratings: 300 V AC, 250 V DC, 15 A, 1500 VA

Make/carry: 20 A continuous; 40 A for 0.2 s (DC voltage); 80 A for 0.2 s (AC voltage)

	Voltage	Break	Maximum load
DC resistive	30 V DC	10 A	300 W
	125 V DC	0.8 A	300 W
	250 V DC	0.4 A	300 W
DC inductive L/R = 40 ms	30 V DC	5 A	150 W
	125 V DC	0.3 A	150 W
	250 V DC	0.2 A	150 W
AC resistive	120 V AC	20 A	5000 VA
	240 V AC	20 A	5000 VA
AC inductive PF = 0.4	120 V AC	8 A	5000 VA
	240 V AC	7 A	5000 VA

AUXILIARY 6 TO 8 RELAYS, SELF-TEST RELAY 9

Configuration: form-C

Contact material: silver alloy

Maximum ratings: 300 V AC, 250 V DC, 15 A, 1500 VA

Make/carry: 10 A continuous; 30 A for 0.2 s

Voltage		Break	Maximum load
DC resistive	30 V DC	10 A	300 W
	125 V DC	0.5 A	62.5 W
	250 V DC	0.3 A	75 W
DC inductive L/R = 40 ms	30 V DC	5 A	150 W
	125 V DC	0.25 A	31.3 W
	250 V DC	0.15 A	37.5 W
AC resistive	120 V AC	10 A	2770 VA
	240 V AC	10 A	2770 VA
AC inductive PF = 0.4	120 V AC	4 A	480 VA
	240 V AC	3 A	750 VA

2.2.5 Miscellaneous

COMMUNICATIONS

All ports:300 to 19200 baud, programmable parity, Modbus RTU protocol, DNP
 Ethernet:10Base-T RJ45 connector
 Modbus TCP/IP
 Version 2.0 / IEEE 802.3

CLOCK

Resolution:1 ms
 Accuracy±1 ms with IRIG-B
 ±1 minute/month without IRIG-B
 Supercap backup life:45 days when control power is off

HARMONICS

Range:0.00 to 99.9%
 Accuracy:±1% of full-scale at 0.5 × CT

THD

Range:0.00 to 99.9%
 Accuracy:±1% of full-scale at 0.5 × CT

EVENT RECORDER

Number of events:256
 Event content:see *Types and causes of events* on page 6–19

OPERATING ENVIRONMENT

Operating temperature: -40°C to +60°C
 Storage temperature:-40°C to +80°C ambient
 Humidity:up to 90% non-condensing
 Altitude:2000 m
 Pollution degree:II

CASE

Drawout:Fully drawout unit (automatic CT shorts)
 Seal:Seal provision
 Door:Dust tight door
 Panel:Panel or 19-inch rack mount
 Weight (case and relay):18 lbs., 6 oz. (8.4 kg)
 IP class:X0

PRODUCTION TESTS

Thermal:.....operational test at ambient then increasing to 60°C

Dielectric strength:2200 VAC for 1 second (per UL & CE)

TYPE WITHSTAND TESTS

The following table lists the 745 type tests:

Standard	Test Name	Level
GE Multilin	Temperature Cycling	-50°C to +80°C
IEC 60068-2-30	Relative Humidity Cyclic	55°C at 95% RH
IEC 60068-2-38	Composite Temperature/Humidity	65/-10°C at 93% RH
IEC 60255-5	Dielectric Strength	2300 V AC
IEC 60255-5	Impulse Voltage	5 kV
IEC 60255-21-1	Sinusoidal Vibration	2 g
IEC 60255-22-1	Damped Oscillatory Burst, 1 MHz	2.5 kV / 1 kV
IEC 60255-22-2	Electrostatic Discharge: Direct	8 kV
IEC 60255-22-3	Radiated RF Immunity	10 V/m
IEC 60255-22-4	Electrical Fast Transient / Burst Immunity	4 kV
IEC 60255-22-5	Surge Immunity	4 kV / 2 kV
IEC 60255-22-6	Conducted RF Immunity, 150 kHz to 80 MHz	10 V/m
IEC 60255-25	Radiated RF Emission	Group 1 Class A
IEC 60255-25	Conducted RF Emission	Group 1 Class A
IEC 60529	Ingress of Solid Objects and Water (IP)	IP40 (front), IP20 (back)
IEC 61000-4-8	Power Frequency Magnetic Field Immunity	30 A/m
IEC 61000-4-9	Pulse Magnetic Field Immunity	1000 A/m
IEC 61000-4-11	Voltage Dip; Voltage Interruption	0%, 40%, 100%
IEEE C37.90.1	Fast Transient SWC	4 kV / 4 kV
IEEE C37.90.1	Oscillatory Transient SWC	2.5 kV / 2.5 kV

APPROVALS

ACA:.....Tick mark

RF Emissions for Australia

CE:.....Conforms to IEC 1010-1 / EN 50082-2

EN:.....EN 50623

EMC - CE for Europe

FCC:.....Part 15; RF Emissions for North America

IEC:.....IEC 1010-1

LVD - CE for Europe

UL:.....UL listed for the USA and Canada, E83849



NOTE

It is recommended that all relays must be powered up once per year, for one hour continuously, to avoid deterioration of electrolytic capacitors and subsequent relay failure.



NOTE

Specifications subject to change without notice.



745 Transformer Protection System

Chapter 3: Installation

3.1 Drawout Case

3.1.1 Case Description

The 745 is packaged in the standard SR-series arrangement, which consists of a drawout relay and a companion case. The case provides mechanical protection for the drawout portion, and is used to make permanent electrical connections to external equipment. Where required, case connectors are fitted with mechanisms, such as automatic CT shorting, to allow the safe removal of the relay from an energized panel. There are no electronic components in the case.

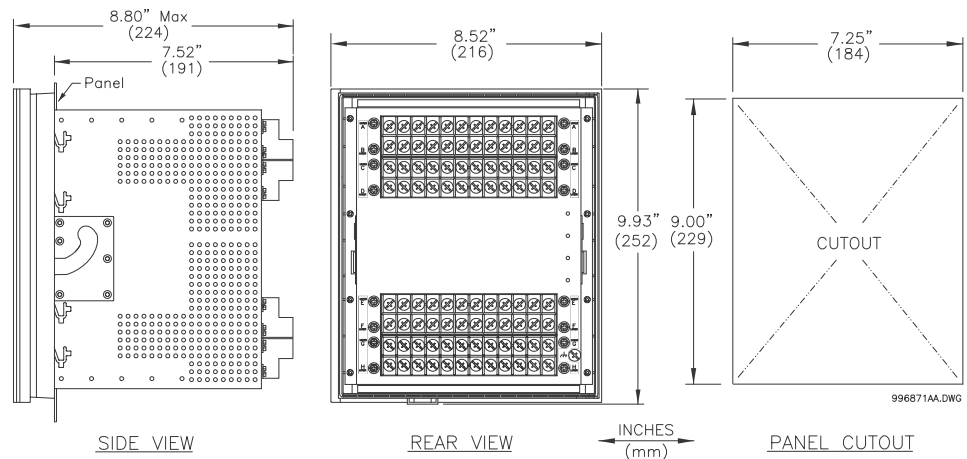

FIGURE 3-1: Case dimensions

3.1.2 Panel Cutout

A 745 can be mounted alone or adjacent to another SR-series unit on a standard 19" rack panel. Panel cutout dimensions for both conditions are as shown. When planning the location of your panel cutout, ensure provision is made for the front door to swing open without interference to or from adjacent equipment.

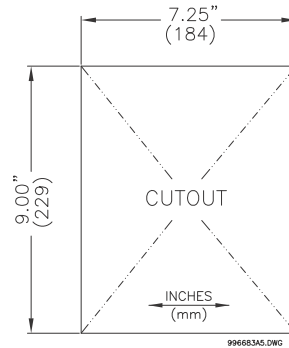

FIGURE 3-2: Single SR-series relay panel cutout

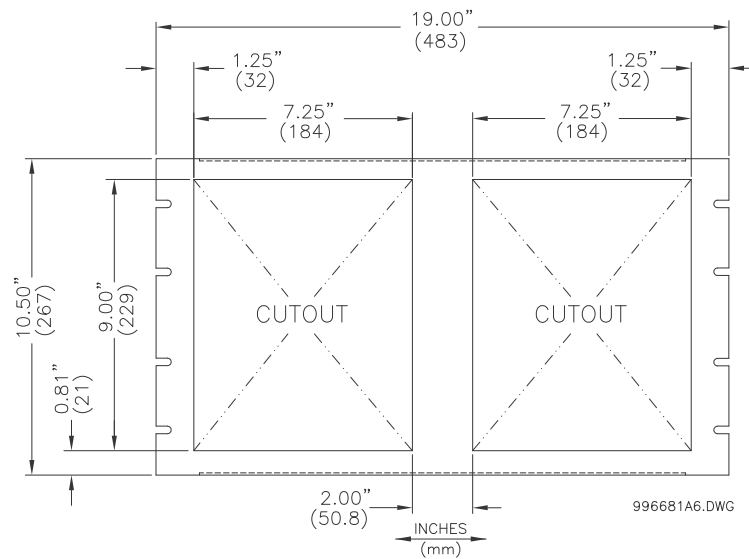

FIGURE 3-3: Double SR-series relay panel cutout

3.1.3 Case Mounting

Before mounting the SR unit in the supporting panel, remove the relay portion from its case, as described in the next section. From the front of the panel, slide the empty case into the cutout. To ensure the front bezel sits flush with the panel, apply pressure to the bezel's front while bending the retaining tabs 90°. These tabs are located on the sides and

bottom of the case and appear as shown in the illustration. After bending all tabs, the case will be securely mounted so that its relay can be inserted. The SR unit is now ready for panel wiring.



FIGURE 3-4: Case mounting

3.1.4 Unit Withdrawal and Insertion



TURN OFF CONTROL POWER BEFORE DRAWING OUT OR RE-INSERTING THE RELAY TO PREVENT MALOPERATION!



If an attempt is made to install a unit into a non-matching case, the mechanical key will prevent full insertion of the unit. Do not apply strong force in the following step or damage may result.

To remove the unit from the case:

1. Open the cover by pulling the upper or lower corner of the right side, which will rotate about the hinges on the left.
2. Release the locking latch, located below the locking handle, by pressing upward on the latch with the tip of a screwdriver.



FIGURE 3-5: Press latch to disengage handle

3. Grasp the locking handle in the center and pull firmly, rotating the handle up from the bottom of the unit until movement ceases.



FIGURE 3-6: Rotate handle to stop position

4. Once the handle is released from the locking mechanism, the unit can freely slide out of the case when pulled by the handle. It may sometimes be necessary to adjust the handle position slightly to free the unit.



FIGURE 3-7: Slide unit out of case

To insert the unit into the case:

1. Raise the locking handle to the highest position.
2. Hold the unit immediately in front of the case and align the rolling guide pins (near the hinges of the locking handle) to the guide slots on either side of the case.

3. Slide the unit into the case until the guide pins on the unit have engaged the guide slots on either side of the case.
4. Grasp the locking handle from the center and press down firmly, rotating the handle from the raised position toward the bottom of the unit.
5. When the unit is fully inserted, the latch will be heard to click, locking the handle in the final position.

To prevent unauthorized removal of the drawout unit, a wire lead seal can be installed in the slot provided on the handle as shown below. With this seal in place, the drawout unit cannot be removed. A passcode or setpoint access jumper can be used to prevent entry of setpoints but still allow monitoring of actual values. If access to the front panel controls must be restricted, a separate seal can be installed on the outside of the cover to prevent it from being opened.



FIGURE 3-8: Drawout unit seal

3.1.5 Ethernet connection

If using the 745 with the Ethernet 10Base-T option, ensure that the network cable is disconnected from the rear RJ45 connector before removing the unit from the case. This prevents any damage to the connector.

The unit may also be removed from the case with the network cable connector still attached to the rear RJ45 connector, provided that there is at least 16 inches of network cable available when removing the unit from the case. This extra length allows the network cable to be disconnected from the RJ45 connector from the front of the switchgear panel. Once disconnected, the cable can be left hanging safely outside the case for re-inserting the unit back into the case.

The unit may then be re-inserted by first connecting the network cable to the units' rear RJ45 connector (see step 3 of *Unit Withdrawal and Insertion* on page 3-3).



Ensure that the network cable does not get caught inside the case while sliding in the unit. This may interfere with proper insertion to the case terminal blocks and damage the cable.



FIGURE 3-9: Ethernet cable connection

To ensure optimal response from the relay, the typical connection timeout should be set as indicated in the following table:

TCP/IP sessions	Timeout setting
up to 2	2 seconds
up to 4	3 seconds

3.2 Typical Wiring

3.2.1 Description

The 745 contains numerous built-in features that allow for a broad range of applications. As such, it is not possible to present connections for all possible schemes. The information in this section covers the important aspects of interconnections, in the general areas of instrument transformer inputs, other inputs, outputs, communications, and grounding.

3.2.2 Rear Terminal Layout

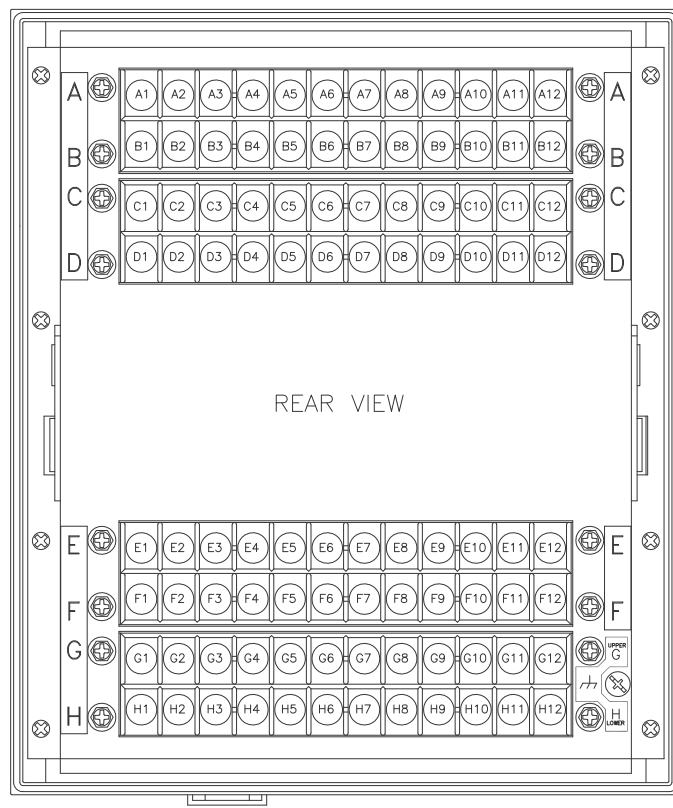

814776A5.DWG

FIGURE 3-10: Rear terminal layout

Table 3-1: Rear terminal assignments (Sheet 1 of 2)

Term.	Description	Term.	Description
Analog interface		Outputs and ground CT N2	
A1	Analog input +	E1	Output 1: solid state trip (+)
A2	Analog input -	E2	Output 2: trip relay (NO)
A3	Tap position (+)	E3	Output 3: trip relay (NO)
A4	Tap position (-)	E4	Output 4: trip relay (NO)
A5	Analog output (common)	E5	Output 5: trip relay (NO)
A6	Analog output 1 (+)	E6	Output 6: auxiliary relay (NO)
A7	Analog output 2 (+)	E7	Output 6: auxiliary relay (NC)
A8	Analog output 3 (+)	E8	Output 7: auxiliary relay (NO)
A9	Analog output 4 (+)	E9	Output 8: auxiliary relay (NO)
A10	Analog output 5 (+)	E10	Output 8: auxiliary relay (NC)
A11	Analog output 6 (+)	E11	Output 9: service relay (common)
A12	Analog output 7 (+)	E12	Ground: winding 2/3 CT
Communications and RTD inputs		Outputs and ground CT N2	
B1	Computer RS485 (+) / RS422 (Rx+)	F1	Output 1: solid state trip (-)
B2	Computer RS485 (-) / RS422 (Rx-)	F2	Output 2: trip relay (common)
B3	Computer RS485/RS422 (common)	F3	Output 3: trip relay (common)
B4	RS422 (Tx+)	F4	Output 4: trip relay (common)
B5	RS422 (Tx-)	F5	Output 5: trip relay (common)
B6	External RS485 (+)	F6	Output 6: auxiliary relay (common)
B7	External RS485 (-)	F7	Output 7: auxiliary relay (NO)
B8	IRIG-B +	F8	Output 7: auxiliary relay (NC)
B9	IRIG-B -	F9	Output 8: auxiliary relay (common)
B10	RTD 1 hot	F10	Output 9: service relay (NO)
B11	RTD 1 compensation	F11	Output 9: service relay (NC)
B12	RTD 1 return	F12	Ground: winding 2/3 CT ■
Logic inputs 9 to 16 and VT input		CT inputs and 745 grounding	
C1	Logic input 9 (+)	G1	Phase A: winding 1 CT
C2	Logic input 10 (+)	G2	Phase B: winding 1 CT
C3	Logic input 11 (+)	G3	Phase C: winding 1 CT
C4	Logic input 12 (+)	G4	Phase A: winding 2 CT
C5	Logic input 13 (+)	G5	Phase B: winding 2 CT
C6	Logic input 14 (+)	G6	Phase C: winding 2 CT
C7	Logic input 15 (+)	G7	Phase A: winding 3 CT
C8	Logic input 16 (+)	G8	Phase B: winding 3 CT
C9	Reserved	G9	Phase C: winding 3 CT
C10	Reserved	G10	Ground: winding 1/2 CT
C11	VT input ■	G11	745 filter ground
C12	VT input	G12	745 safety ground
Logic inputs 1 to 8 and dedicated inputs		CT and VT inputs / power	
D1	Logic input 1 (+)	H1	Phase A: winding 1 CT ■
D2	Logic input 2 (+)	H2	Phase B: winding 1 CT ■
D3	Logic input 3 (+)	H3	Phase C: winding 1 CT ■
D4	Logic input 4 (+)	H4	Phase A: winding 2 CT ■

Table 3-1: Rear terminal assignments (Sheet 2 of 2)

Term.	Description	Term.	Description
D5	Logic input 5 (+)	H5	Phase B: winding 2 CT ■
D6	Logic input 6 (+)	H6	Phase C: winding 2 CT ■
D7	Logic input 7 (+)	H7	Phase A: winding 3 CT ■
D8	Logic input 8 (+)	H8	Phase B: winding 3 CT ■
D9	Setpoint access (+)	H9	Phase C: winding 3 CT ■
D10	Setpoint access (-)	H10	Ground: winding 1/2 CT ■
D11	Logic power out (+)	H11	Control power (-)
D12	Logic power out (-)	H12	Control power (+)



NOTE

The ■ symbol indicates the high side of CT and VT terminals

3.2.3 Wiring Diagrams

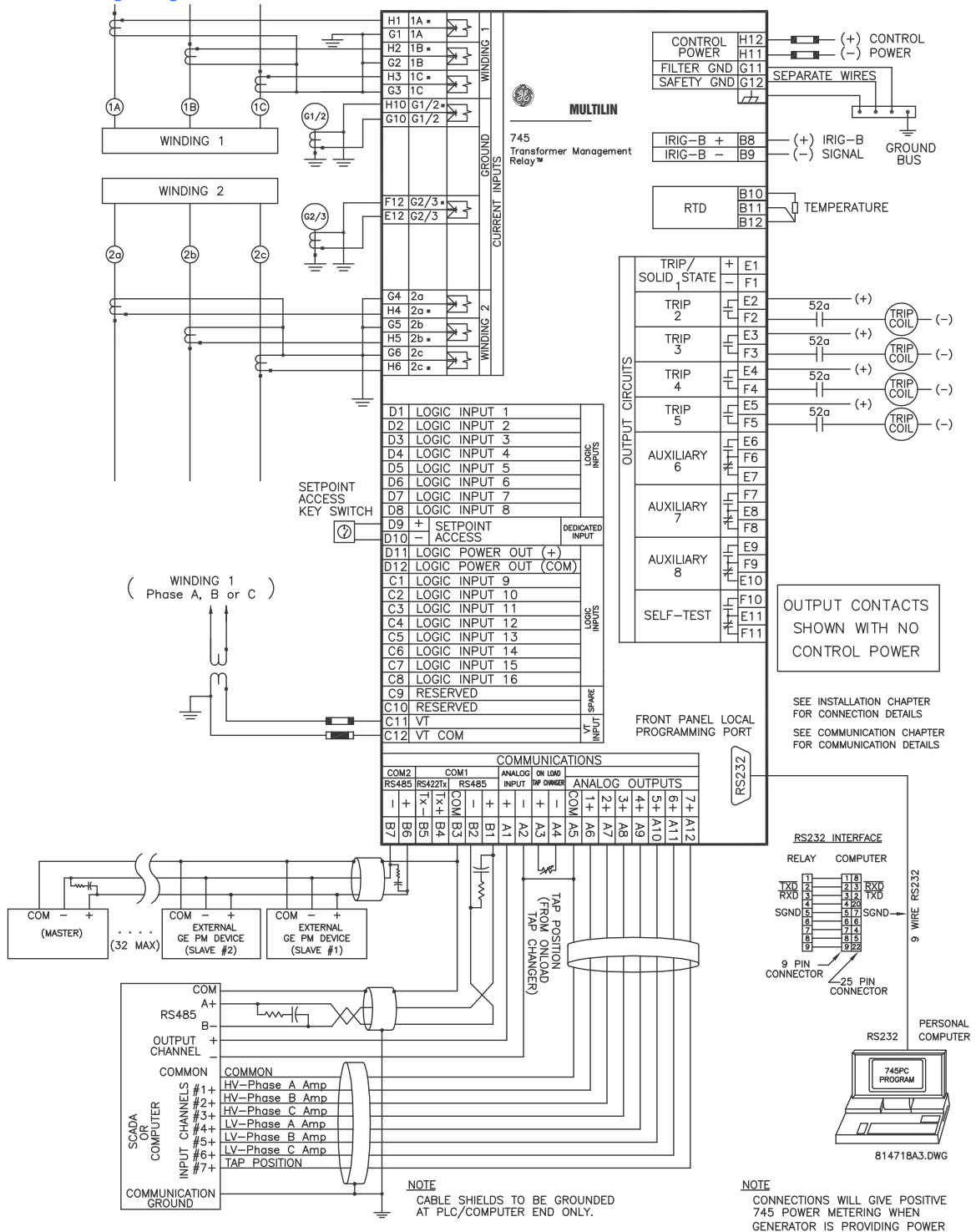

FIGURE 3-11: Typical wiring for two-winding transformer



Since the relay takes one voltage input, power and var metering is not accurate for unbalanced conditions. In addition, depending on which winding the VT is on, the power flows and vars displayed may be opposite in direction to the actual system flow; e.g. in the

case of a generator step-up transformer, depending on the relay winding assignments and which side of the transformer the VT is connected to, the power may be negative when the generator is producing positive MW. This can be corrected by reversing the voltage input into C11 and C12.

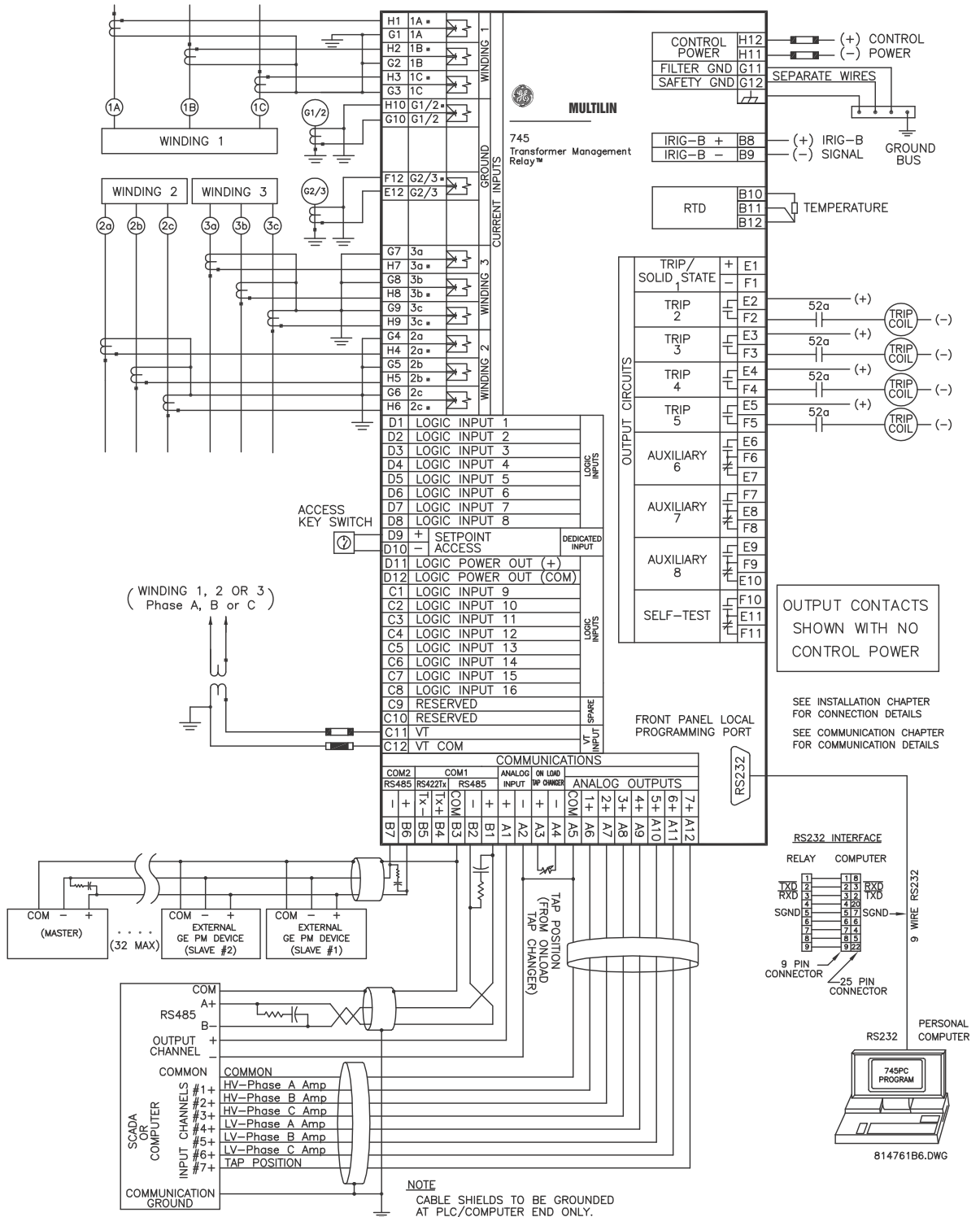

FIGURE 3-12: Typical wiring for three-winding transformer

3.2.4 Phase Sequence and Transformer Polarity

For the correct operation of many relay features, the phase sequence and instrument transformer polarities shown on the typical wiring diagram must be followed. Note the markings shown with all instrument transformer connections. When the connections adhere to this drawing, the relay will operate properly.

3.2.5 Current Transformer Inputs

The 745 has eight or eleven channels for AC current inputs, each with an isolating transformer and an automatic shorting mechanism that acts when the relay is withdrawn from its case. There are no internal ground connections on the current inputs. Current transformers with 1 to 50000 A primaries may be used.

The SR-745 Relay has inputs for either two or three transformer windings (specified at the time of ordering) and for two ground current inputs, G1/2 and G2/3. Refer to the wiring diagrams below for details. Upon transformer type selection, the ground inputs are associated to one or another winding under the following conditions:

1. The ground input settings will be shown in the winding configuration for the transformer type selections associated with a ground input.
2. When a 2-winding transformer is selected, ground inputs are enabled, on both, and are pre-assigned. G1/2 is assigned to winding 1, and G2/3 is assigned to winding 2.
3. When a 3-winding transformer is selected, both ground inputs are enabled, and are associated with the windings via the following rules (see table 3-2):
 - The 50G function is enabled for all connection scenarios (ie: delta and wye).
 - Flexibility is provided to the user in the case of a 3-winding transformer, so the user can assign G1/2 and G2/3 Ground inputs to any two of the three available windings.
4. Robustness, built into the relay, will not allow the user to assign a ground input to more than one winding. In the EnerVista 745 software, a flag informs the user with the text: "Ground CT Input 'G#/#' has already been selected for another winding". On the relay firmware, "Input Function is Already Assigned" text is displayed.

The following table shows the ground inputs use for typical transformer setups:

Table 3-2: Typical Ground Input Connections

TRANSFORMER WINDING CONNECTIONS			WINDING ASSOCIATED WITH GROUND INPUT	
WINDING 1	WINDING 2	WINDING 3	G1/2	G2/3
Wye	Wye	--	Winding 1	Winding 2
Delta	Delta	--	Winding 1	Winding 2
Delta	Wye	--	Winding 1	Winding 2
Delta	Delta	--	Winding 1	Winding 2
Wye	Zig-Zag	--	Winding 1	Winding 2
Delta	Zig-Zag	--	Winding 1	Winding 2
Wye	Wye	Wye	Winding 1	Winding 2
Wye	Wye	Wye	Winding 2	Winding 3
Wye	Wye	Wye	Winding 3	Winding 1
Wye	Wye	Wye	Winding 2	Winding 1

Table 3–2: Typical Ground Input Connections

TRANSFORMER WINDING CONNECTIONS			WINDING ASSOCIATED WITH GROUND INPUT	
WINDING 1	WINDING 2	WINDING 3	G1/2	G2/3
Wye	Wye	Wye	Winding 3	Winding 2
Wye	Wye	Wye	Winding 1	Winding 3
Wye	Wye	Delta	Winding 1	Winding 2
Wye	Wye	Delta	Winding 1	Winding 3
Wye	Wye	Delta	Winding 2	Winding 3
Wye	Wye	Delta	Winding 2	Winding 1
Wye	Wye	Delta	Winding 3	Winding 1
Wye	Wye	Delta	Winding 3	Winding 2
Wye	Delta	Wye	Winding 1	Winding 3
Wye	Delta	Wye	Winding 1	Winding 2
Wye	Delta	Wye	Winding 2	Winding 3
Wye	Delta	Wye	Winding 3	Winding 1
Wye	Delta	Wye	Winding 2	Winding 1
Wye	Delta	Wye	Winding 3	Winding 2
Wye	Delta	Delta	Winding 1	Winding 2
Wye	Delta	Delta	Winding 1	Winding 3
Wye	Delta	Delta	Winding 2	Winding 3
Wye	Delta	Delta	Winding 2	Winding 1
Wye	Delta	Delta	Winding 3	Winding 1
Wye	Delta	Delta	Winding 3	Winding 2
Delta	Wye	Wye	Winding 1	Winding 2
Delta	Wye	Wye	Winding 1	Winding 3
Delta	Wye	Wye	Winding 2	Winding 3
Delta	Wye	Wye	Winding 2	Winding 1
Delta	Wye	Wye	Winding 3	Winding 1
Delta	Wye	Wye	Winding 3	Winding 2
Delta	Wye	Delta	Winding 1	Winding 2
Delta	Wye	Delta	Winding 1	Winding 3
Delta	Wye	Delta	Winding 2	Winding 3
Delta	Wye	Delta	Winding 2	Winding 1
Delta	Wye	Delta	Winding 3	Winding 1
Delta	Wye	Delta	Winding 3	Winding 2
Delta	Delta	Delta	Winding 1	Winding 2
Delta	Delta	Delta	Winding 1	Winding 3
Delta	Delta	Delta	Winding 2	Winding 3
Delta	Delta	Delta	Winding 2	Winding 1
Delta	Delta	Delta	Winding 3	Winding 1
Delta	Delta	Delta	Winding 3	Winding 2
Delta	Delta	Wye	Winding 1	Winding 2
Delta	Delta	Wye	Winding 1	Winding 3
Delta	Delta	Wye	Winding 2	Winding 3
Delta	Delta	Wye	Winding 2	Winding 1
Delta	Delta	Wye	Winding 3	Winding 1
Delta	Delta	Wye	Winding 3	Winding 2



Verify that the relay's nominal current of 1 A or 5 A matches the secondary rating of the connected CTs. Unmatched CTs may result in equipment damage or inadequate protection.

The exact placement of a zero-sequence CT so that ground fault current will be detected is shown below. Twisted pair cabling on the zero-sequence CT is recommended.



IMPORTANT: The relay will correctly measure up to 46 times the current input nominal rating. Time overcurrent curves become horizontal lines for currents above the $46 \times$ CT rating.

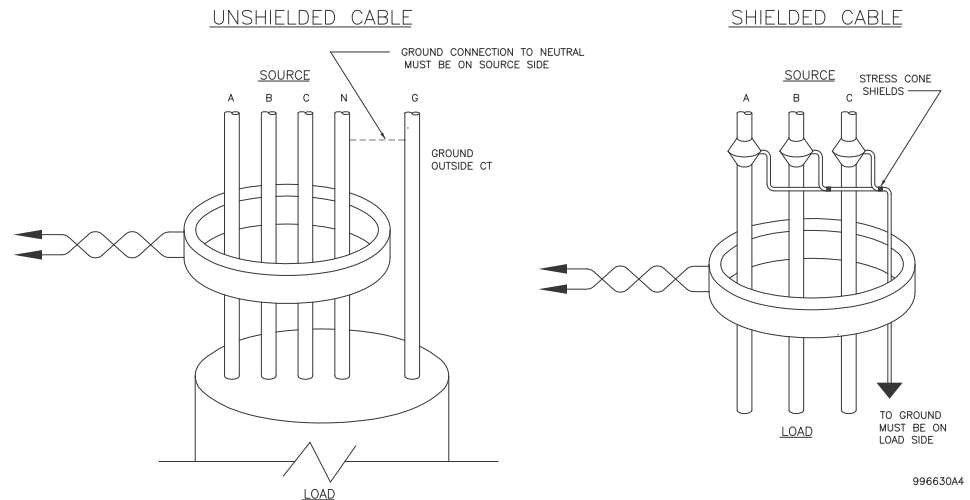

FIGURE 3-13: Zero-sequence (core balance) CT installation

3.2.6 AC Voltage Input

The 745 has one voltage divider type input for AC voltages. There are no internal fuses or ground connections. Voltage transformers up to a maximum 5000:1 ratio may be used. The nominal secondary voltage must be in the 60 to 120 V range.

3.2.7 Logic Inputs

External contacts can be connected to the 16 logic inputs. As shown, these contacts can be either dry or wet. It is also possible to use a combination of both contact types.

A dry contact has one side connected to terminal D11. This is the +32 V DC voltage rail. The other side is connected to the required logic input terminal. When a dry contact closes, a 2.2 mA current flows through the associated circuit.

A wet contact has one side connected to the positive terminal of an external DC power supply. The other side is connected to the required logic input terminal. In addition, the negative side of the external source must be connected to the relay DC negative rail at terminal D12. The maximum external source voltage for this arrangement is 300 V DC.



Correct polarity must be observed for all logic input connections or equipment damage may result.

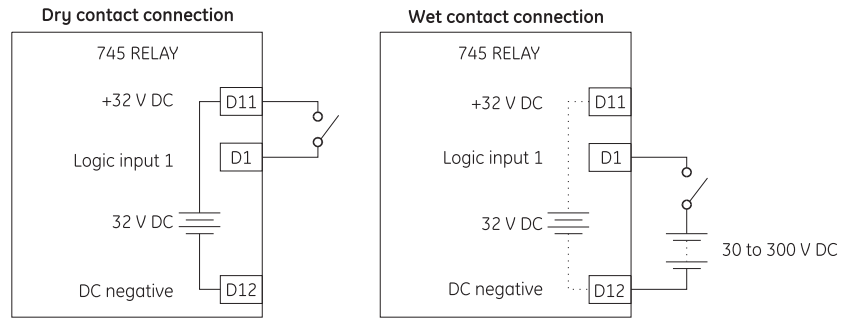

FIGURE 3-14: Dry and wet contact connections

3.2.8 Control Power

The label found on the left side of the relay specifies its order code or model number. The installed power supply operating range will be one of the following.

- LO: 25 to 60 V DC or 20 to 48 V AC
- HI: 88 to 300 V DC or 70 to 265 V AC

Ensure the applied control voltage matches the requirements of the relay’s switching power supply. For example, the HI power supply will work with any DC voltage from 88 to 300 V, or any AC voltage from 70 to 265 V. The internal fuse may blow if the applied voltage exceeds this range.



Control power supplied to the relay must match the installed power supply range. If the applied voltage does not match, damage to the unit may occur.

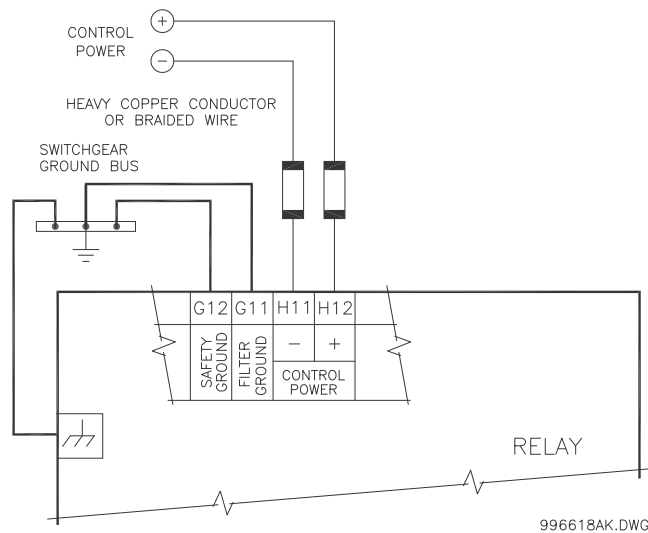

FIGURE 3-15: Control power connection

Extensive filtering and transient protection are built into the 745 to ensure proper operation in harsh industrial environments. Transient energy must be conducted back to the source through the filter ground terminal. A separate safety ground terminal is provided for dielectric strength (hi-pot) testing.

3.2.9 Analog Input

Terminals A1 (+) and A2 (-) are provided for the input of a current signal, from one of the following: 0 to 1 mA, 0 to 5 mA, 0 to 20 mA, or 4 to 20 mA transducer outputs. This current signal can represent any external quantity, such as temperature, current or voltage. Be sure to observe polarity markings for correct operation. Both terminals are clamped to within 36 volts of ground with surge protection. As such, common mode voltages should not exceed this limit. Shielded wire, with only one end of the shield grounded, is recommended to minimize noise effects. The A2 (-) terminal must be connected to the A5 (analog output common) terminal at the 745.

3.2.10 Tap Position Input

Terminals A3 (+) and A4 (-) are provided to monitor the position of an onload tap changer from a stepped-resistance position indicator device. Terminal A3 is connected internally to a 4.3 mA current source. This current is used to measure the value of the external resistance. The 745 uses the measured resistance value to calculate the tap position. See *Dynamic CT Ratio Mismatch Correction* on page 5–6 for more details on the tap position input.

The maximum total resistance the tap changer input can measure is 5.1 k Ω . For example, the maximum resistance increment per tap for a 33-position tap changer should not exceed 151 Ω .

3.2.11 RTD Driver/Sensor

Terminals B10 (RTD hot), B11 (RTD compensation) and B12 (RTD return) provide for the connection of various types of RTD devices. This connection may be made using two or three wires to the RTD. Terminal B10 is connected internally to a 5 mA current source for energizing the RTD. Terminal B11 is connected internally to a 5 mA current source for the purpose of cancelling out the resistance of the wires connecting the RTD to the 745. Terminal B12 is the return path for the two current sources.

In the three-wire connection scheme, the connection from terminal B11 to B12 is made at the RTD. The three-wire connection scheme compensates for the resistance of the wiring between the 745 and the RTD.

In the two-wire connection scheme, the connection from terminal B11 to B12 is made at the terminal block on the rear of the 745. This connection must not be omitted. The two-wire connection scheme does not compensate for the resistance of the wiring between the 745 and the RTD.

3.2.12 Output Relays

Eight output relays are provided with the 745. Output relays 2 through 5 have form-A contacts while output relays 6 to 8 and the self-test relay, have form-C contacts. Since output relays 2 to 5 are intended for operating a breaker trip coil, the form-A contacts have higher current ratings than the form-C contacts. Note that the operating mode of the self-test relay is fixed, while the other relays can be assigned through the Protection Elements menu, or programmed by the user via the FlexLogic™ feature.

3.2.13 Solid State Trip Output

A high-speed solid state (SCR) output is also provided. This output is intended for applications where it is necessary to key a communications channel.

3.2.14 Analog Outputs

The 745 provides 7 analog output channels whose full scale range can be set to one of the following ranges: 0 to 1 mA; 0 to 5 mA; 0 to 10 mA; 0 to 20 mA; and 4 to 20 mA. Each analog output channel can be programmed to represent one of the parameters measured by the relay. For details, see *Analog Outputs 1 to 7* on page 5–43.

As shown in the typical wiring diagram, the analog output signals originate from Terminals A6 to A12 and share A5 as a common return. Output signals are internally isolated and allow connection to devices which sit at a different ground potential. Each analog output terminal is clamped to within 36 V of ground. To minimize the effects of noise, external connections should be made with shielded cable and only one end of the shield should be grounded.

If a voltage output is required, a burden resistor must be connected at the input of the external measuring device. Ignoring the input impedance, the burden resistance is:

$$R_{LOAD} = \frac{V_{FULL-SCALE}}{I_{MAX}} \quad (\text{EQ 3.1})$$

If a 5 V full scale output is required with a 0 to 1 mA output channel, $R_{LOAD} = 5 \text{ V} / 0.001 \text{ A} = 5 \text{ K}\Omega$. Similarly, for a 0 to 5 mA channel this resistor would be 1 K Ω ; for a 0 to 10 mA channel, this resistor would be 500 Ω ; and for a 4 to 20 mA channel this resistor would be 250 Ω .

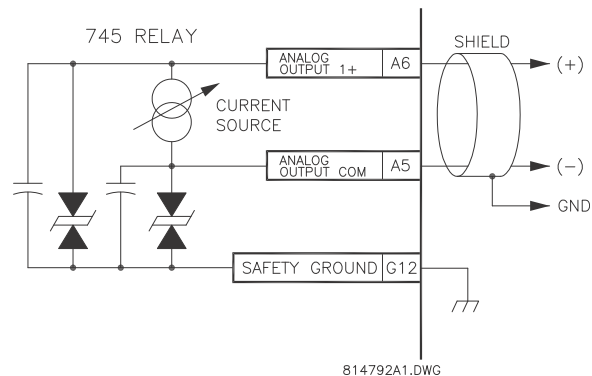

FIGURE 3–16: Analog output connection

3.2.15 RS485/RS422 Communications

The 745 provides the user with two rear communication ports which may be used simultaneously. Both implement a subset of the AEG Modicon Modbus protocol as outlined in publication GEK-106636A: *745 Communications Guide*.

The COM1 port can be used in the two-wire RS485 mode or the four-wire RS422 mode, but will not operate in both modes at the same time. In RS485 mode, data transmission and reception are accomplished over a single twisted pair with transmit and receive data alternating over the same two wires. These wires should be connected to the terminals

marked RS485. The RS422 mode uses the COM1 terminals designated as RS485 for receive lines, and the COM1 terminals designated as RS422 for transmit lines. The COM2 port is intended for the two wire RS485 mode only. Through the use of these ports, continuous monitoring and control from a remote computer, SCADA system or PLC is possible.

To minimize errors from noise, the use of shielded twisted-pair wire is recommended. Correct polarity should also be observed. For instance, the relays must be connected with all B1 terminals (labeled COM1 RS485+) connected together, and all B2 terminals (labeled COM1 RS485-) connected together. Terminal B3 (labeled COM1 RS485 COM) should be connected to the common wire inside the shield. To avoid loop currents, the shield should be grounded at one point only. Each relay should also be daisy-chained to the next in the link. A maximum of 32 relays can be connected in this manner without exceeding driver capability. For larger systems, additional serial channels must be added. It is also possible to use commercially available repeaters to include more than 32 relays on a single channel. Star or stub connections should be avoided entirely.

Lightning strikes and ground surge currents can cause large momentary voltage differences between remote ends of the communication link. For this reason, surge protection devices are internally provided at both communication ports. An isolated power supply with an optocoupled data interface also acts to reduce noise coupling. To ensure maximum reliability, all equipment should have similar transient protection devices installed.

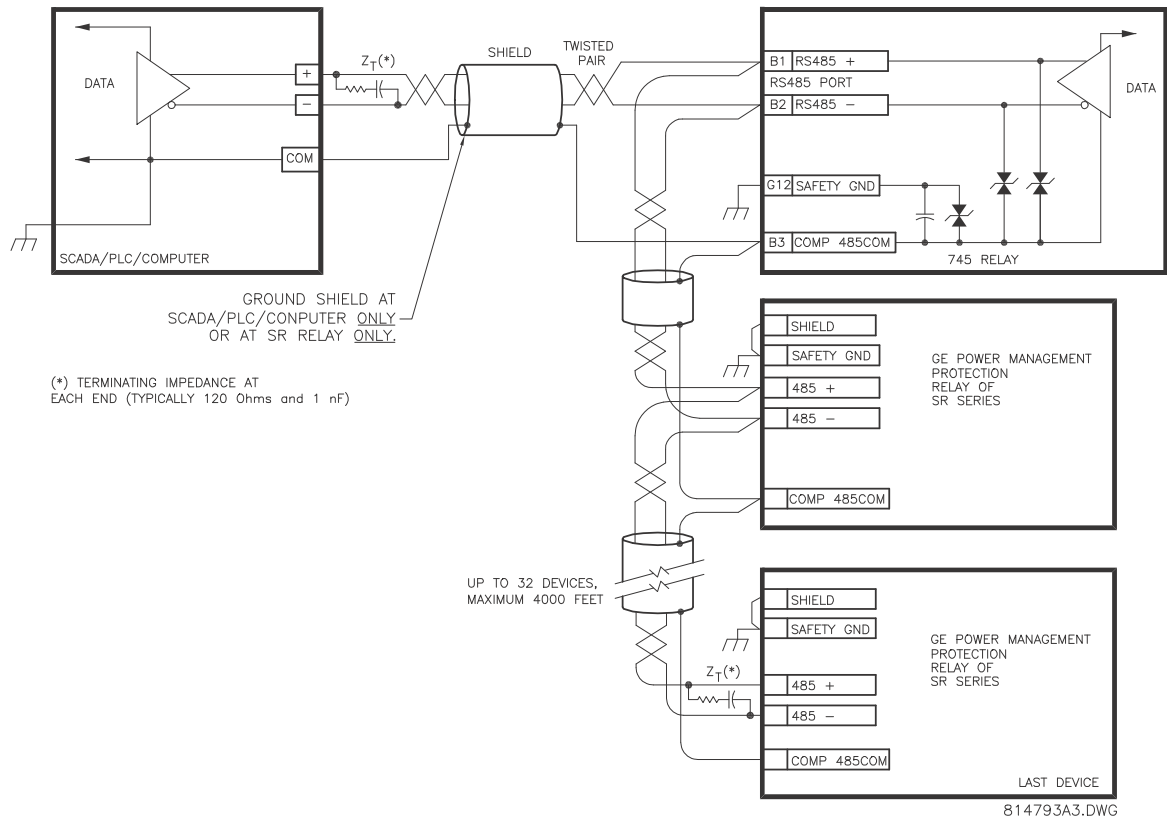

FIGURE 3-17: RS485 wiring

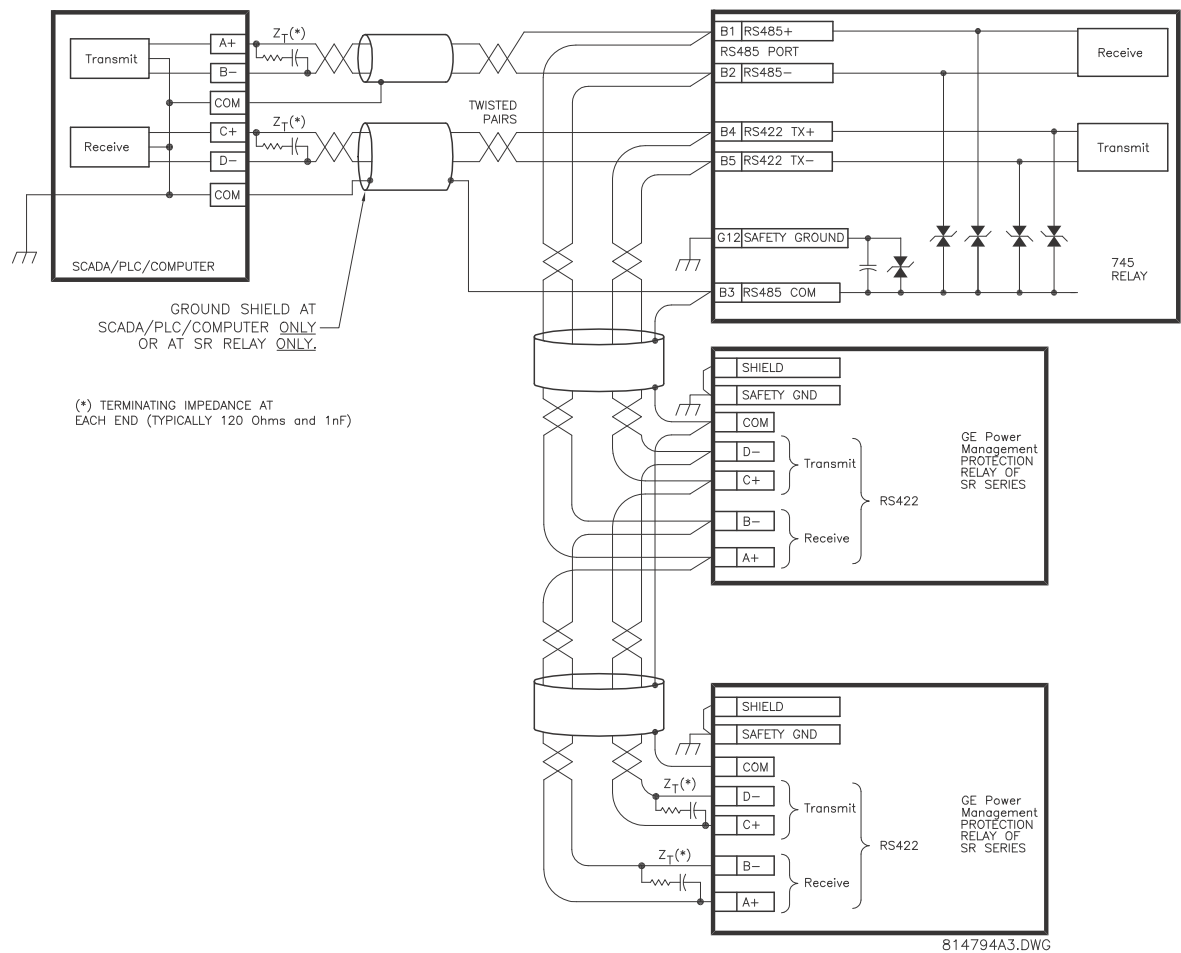

FIGURE 3-18: RS422 wiring

3.2.16 RS232 Front Panel Program Port

A 9 pin RS232C serial port is located on the front panel for programming through a PC. This port uses the same Modbus protocol as the two rear ports. The EnerVista 745 Setup software required to use this interface is included with the relay. Cabling for the RS232 port is shown below for both 9 pin and 25 pin connectors.

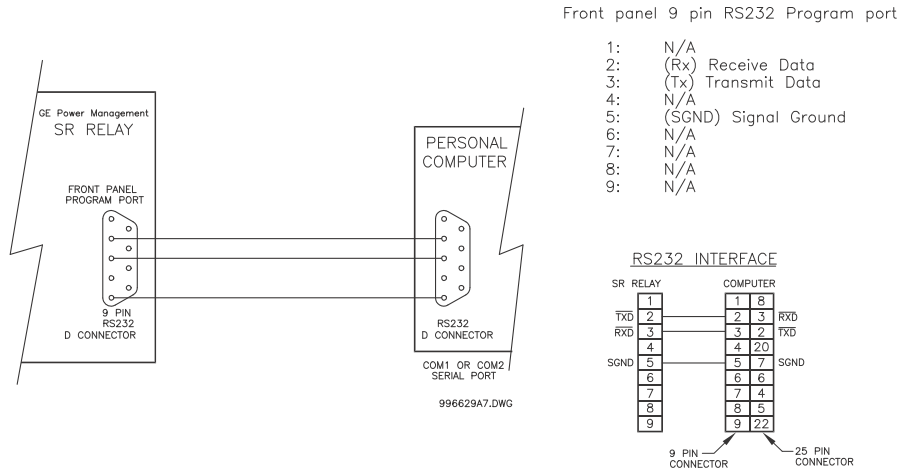

FIGURE 3-19: RS232 Wiring

3.2.17 IRIG-B

IRIG-B is a standard time code format that allows stamping of events to be synchronized among connected devices within 1 millisecond. The IRIG time code formats are serial, width-modulated codes which can be either DC level shifted or amplitude modulated (AM). Third party equipment is available for generating the IRIG-B signal; this equipment may use a GPS satellite system to obtain the time reference so that devices at different geographic locations can also be synchronized.

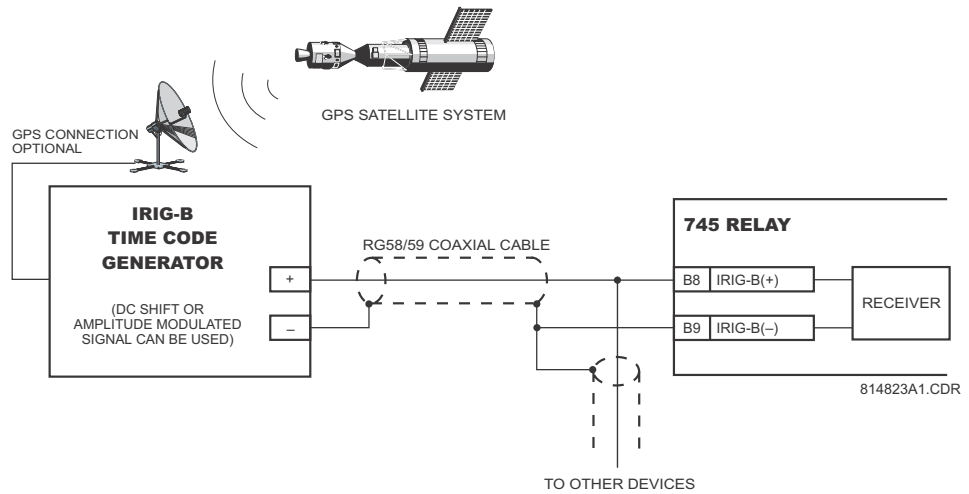

FIGURE 3-20: IRIG-B function

3.2.18 Dielectric Strength

Dielectric strength test was performed on the 745 relay at the manufacturer. It is not necessary to perform this test again at the customer site. However, if you wish to perform this test, follow instructions outlined in *Dielectric Strength Testing* on page 7-6.



NOTE

No special ventilation requirements need to be observed during the installation of the unit. The unit does not have to be cleaned.



WARNING

Hazard may result if the product is not used for its intended purpose.



745 Transformer Protection System

Chapter 4: Interfaces

4.1 Hardware Interface

4.1.1 Front Panel

The front panel provides a local operator interface with a 40-character liquid crystal display, LED status indicators, control keys, and program port. The display and status indicators update alarm and status information automatically. The control keys are used to select the appropriate message for entering setpoints or displaying measured values. The RS232 program port is also provided for connection with a computer running the EnerVista 745 Setup software.

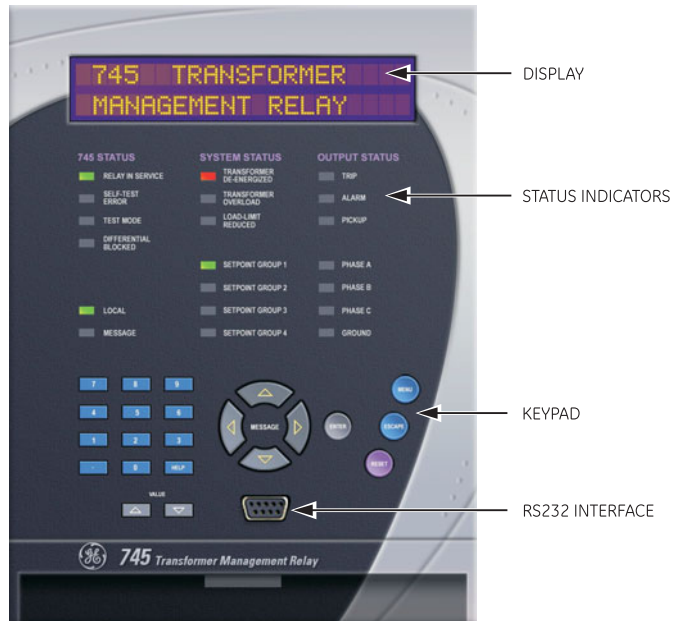

FIGURE 4-1: 745 front panel view

4.1.2 Display

All messages are displayed in English on the 40-character liquid crystal display, which is backlit for visibility under varied lighting conditions. When the keypad and display are not actively being used, the screen sequentially displays up to 30 user-selected default messages providing system information. These messages appear after a time of inactivity that is programmable by the user. Pressing any key after default messages have appeared will return the display to the last message displayed before the default messages appeared. Trip and alarm condition messages automatically override default messages. All display pixels are illuminated briefly during power up self-testing, and can be energized by pressing any key when no trips or alarms are active.

4.1.3 LEDs

Front panel indicators are grouped in three columns: Relay Status, which provides information about the state of the 745; System Status, which provides information about the state of the transformer and the power system; and Output Status, which provides details about abnormal conditions that have been detected. The color of each indicator conveys information about its importance:

- GREEN (G): indicates a general condition
- AMBER (A): indicates an alert condition
- RED (R): indicates a serious alarm or warning

4.1.4 LED Indicators

4.1.4.1 745 Status

- **RELAY IN SERVICE:** The In Service LED is on when relay protection is operational. The indicator is on only if all of the following conditions are met:
 - The [S1 745 SETUP ▷ ▾ INSTALLATION ▷ ▾ 745 SETPOINTS](#) setpoint is set to “Programmed”.
 - The [S6 TESTING ▷ OUTPUT RELAYS ▷ FORCE OUTPUT RELAYS FUNCTION](#) setpoint is set to “Disabled”.
 - The [S6 TESTING ▷ ▾ SIMULATION ▷ SIMULATION SETUP ▷ SIMULATION FUNCTION](#) setpoint is set to “Disabled”.
 - No self-test errors which have an effect on protection have been detected.
 - Code programming mode is inactive.
 - Factory service mode is disabled.
- **SELF-TEST ERROR:** The Self-Test Error LED is on when any of the self-diagnostic tests, performed either at power-on or in the background during normal operation, has detected a problem with the relay.
- **TEST MODE:** The Test Mode LED indicator is on when any of the 745 testing features has been enabled. The indicator is on if any of the following conditions are met:
 - The [S6 TESTING ▷ OUTPUT RELAYS ▷ FORCE OUTPUT RELAYS FUNCTION](#) setpoint is set to “Enabled”.
 - The [S6 TESTING ▷ ▾ ANALOG OUTPUTS ▷ FORCE ANALOG OUTPUTS FUNCTION](#) setpoint is “Enabled”.

- The [S6 TESTING ▷ ▾ SIMULATION ▷ SIMULATION SETUP ▷ SIMULATION FUNCTION](#) setpoint is set to “Prefault Mode”, “Fault Mode”, or “Playback Mode”.
- Factory service mode is enabled.
- **DIFFERENTIAL BLOCKED:** The Differential Blocked LED is on when the restrained differential protection feature is enabled but is being blocked from operating by any of the harmonic inhibit features. The indicator is on if the harmonic inhibit element is blocking any phase (see *Harmonic inhibit* on page 5–52).
- **LOCAL:** The Local LED indicator is on when the 745 is in local mode, i.e. the front panel RESET key is operational.
- **MESSAGE:** The Message LED indicator is on when any element has picked up, operated, or is now in a latched state waiting to be reset. With this indicator on, the front panel display is sequentially displaying information about each element that has detected an abnormal condition.

4.1.4.2 System Status Indicators

- **TRANSFORMER DE-ENERGIZED:** The Transformer De-Energized LED indicator is on when the energization inhibit feature has detected that the transformer is de-energized. The indicator is on if the Energization Inhibit feature is detecting the transformer as de-energized
- **TRANSFORMER OVERLOAD:** The Transformer Overload LED indicator is on when the Transformer Overload element has operated.
- **LOAD-LIMIT REDUCED:** The Load-Limit Reduced LED indicator is on when the adaptive harmonic factor correction feature is detecting enough harmonic content to reduce the load rating of the transformer. The indicator is on if [S2 SYSTEM SETUP ▷ ▾ HARMONICS ▷ HARMONIC DERATING ESTIMATION](#) is “Enabled” and the harmonic derating function is below 0.96.
- **SETPOINT GROUP 1(4):** These indicators reflect the currently active setpoint group. The indicators flash when the corresponding setpoint group is being edited.

4.1.4.3 Output Status Indicators

- **TRIP:** The Trip LED is on when any output relay selected to be of the **Trip** type has operated.
- **ALARM:** The Alarm LED is on when any output relay selected to be of the **Alarm** type has operated.
- **PICKUP:** The Pickup LED is on when any element has picked up. With this indicator on, the front panel display is sequentially displaying information about each element that has picked up.
- **PHASE A (C):** The Phase A(C) LEDs are on when phase A(C) is involved in the condition detected by any element that has picked up, operated, or is now in a latched state waiting to be reset.
- **Ground:** The Ground LED is on when ground is involved in the condition detected by any element that has picked up, operated, or is now in a latched state waiting to be reset.

4.1.5 Program Port

Use the front panel program port for RS232 communications with the 745. As described in *RS232 Front Panel Program Port* on page 3–19, all that is required is a connection between the relay and a computer running EnerVista 745 Setup. For continuous monitoring of multiple relays, use the COM1 RS485/RS422 port or the COM2 RS485 port.

4.1.6 Keypad

4.1.6.1 Description

The 745 display messages are organized into main menus, pages, and sub-pages. There are three main menus labeled setpoints, actual values, and target messages.

Pressing the MENU key followed by the MESSAGE DOWN key scrolls through the three main menu headers, which appear in sequence as follows:

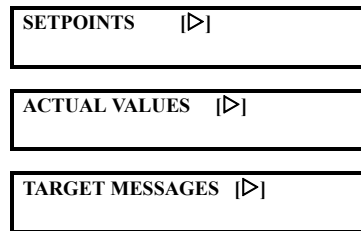

Pressing the MESSAGE RIGHT or ENTER key from these main menu pages will display the corresponding menu page. Use the MESSAGE keys to scroll through the page headers.

When the display shows **SETPOINTS**, pressing the MESSAGE RIGHT or ENTER key will display the page headers of programmable parameters (referred to as setpoints in the manual). When the display shows **ACTUAL VALUES**, pressing the MESSAGE RIGHT or ENTER key displays the page headers of measured parameters (referred to as actual values in the manual). When the display shows **TARGET MESSAGES**, pressing the MESSAGE RIGHT or ENTER key displays the page headers of event messages or alarm conditions.

Each page is broken down further into logical sub-pages. The MESSAGE keys are used to navigate through the sub-pages. A summary of the setpoints and actual values can be found in the chapters 5 and 6, respectively.

The ENTER key is dual purpose. It is used to enter the sub-pages and to store altered setpoint values into memory to complete the change. The MESSAGE RIGHT key can also be used to enter sub-pages but not to store altered setpoints.

The ESCAPE key is also dual purpose. It is used to exit the sub-pages and to cancel a setpoint change. The MESSAGE LEFT key can also be used to exit sub-pages and to cancel setpoint changes.

The VALUE keys are used to scroll through the possible choices of an enumerated setpoint. They also decrement and increment numerical setpoints. Numerical setpoints may also be entered through the numeric keypad.

The RESET key resets any latched conditions that are not presently active. This includes resetting latched output relays, latched Trip LEDs, breaker operation failure, and trip coil failure.

The MESSAGE keys scroll through any active conditions in the relay. Diagnostic messages are displayed indicating the state of protection and monitoring elements that are picked up, operating, or latched. When the Message LED is on, there are messages to be viewed with the MENU key by selecting target messages as described earlier.

4.1.6.2 Entering alphanumeric text

Text setpoints have data values that are fixed in length but user-defined in character. They may be comprised of upper case letters, lower case letters, numerals, and a selection of special characters. The editing and storing of a text value is accomplished with the use of the decimal, VALUE, and ENTER keys.

1. Move to message **S3 LOGIC INPUTS > LOGIC INPUTS > LOGIC INPUT 1 > INPUT 1 FUNCTION**, and scrolling with the VALUE keys, select "Enabled". The relay will display the following message:

INPUT 1 FUNCTION: Enabled
--

2. Press the MESSAGE DOWN key twice to view the **INPUT NAME** setpoint. The name of this user-defined input will be changed in this example from the generic "Logic Input 1" to something more descriptive.
3. If an application is to be using the relay as a transformer monitor, it may be more informative to rename this input "Tx. Monitor". Press decimal to enter the text editing mode. The first character will appear underlined as follows:

INPUT 1 NAME: <u>L</u> ogic Input 1

4. Press the VALUE keys until the character "T" is displayed in the first position. Now press the decimal key to store the character and advance the cursor to the next position. Change the second character to a "x" in the same manner. Continue entering characters in this way until all characters of the text "Tx. Monitor" are entered. Note that a space is selected like a character. If a character is entered incorrectly, press the decimal key repeatedly until the cursor returns to the position of the error. Re-enter the character as required. Once complete, press the ENTER key to remove the solid cursor and view the result. Once a character is entered, by pressing the ENTER key, it is automatically saved in Flash Memory, as a new setpoint.

INPUT 1 NAME: Tx. Monitor
--

5. The 745 does not have '+' or '-' keys. Negative numbers may be entered in one of two manners.
 - Immediately pressing one of the VALUE keys causes the setpoint to scroll through its range including any negative numbers.
 - After entering at least one digit of a numeric setpoint value, pressing the VALUE keys changes the sign of the value where applicable.

4.1.7 Setpoint Entry

To store any setpoints, terminals D9 and D10 (access terminals) must be shorted (a keyswitch may be used for security). There is also a setpoint passcode feature that restricts access to setpoints. The passcode must be entered to allow the changing of setpoint

values. A passcode of "0" effectively turns off the passcode feature - in this case only the access jumper is required for changing setpoints. If no key is pressed for 5 minutes, access to setpoint values will be restricted until the passcode is entered again. To prevent setpoint access before the 5 minutes expires, the unit may be turned off and back on, the access jumper may be removed, or the **SETPOINT ACCESS** setpoint may be changed to "Restricted". The passcode cannot be entered until terminals D9 and D10 (access terminals) are shorted. When setpoint access is allowed, the Setpoint Access LED indicator on the front of the 745 will be lit.

Setpoint changes take effect immediately, even when transformer is running. However, changing setpoints while the transformer is running is not recommended as any mistake may cause a nuisance trip.

The following procedure may be used to access and alter setpoints. This specific example refers to entering a valid passcode to allow access to setpoints if the passcode was "745".

1. Press the MENU key to access the header of each menu, which will be displayed in the following sequence:

SETPOINTS |▷|

ACTUAL VALUES |▷|

TARGET MESSAGES |▷|

2. Press the MENU key until the display shows the header of the setpoints menu, then press the MESSAGE RIGHT or ENTER key to display the header for the first setpoints page. The set point pages are numbered, have an 'S' prefix for easy identification and have a name which gives a general idea of the settings available in that page. Pressing the MESSAGE keys will scroll through all the available setpoint page headers. Setpoint page headers look as follows:

■ **SETPOINTS** |▷|
S1 745 SETUP

3. To enter a given setpoints page, press the MESSAGE RIGHT or ENTER key. Press the MESSAGE keys to scroll through sub-page headers until the required message is reached. The end of a page is indicated by the message **END OF PAGE**. The beginning of a page is indicated by the message **TOP OF PAGE**.
4. Each page is broken further into subgroups. Press MESSAGE UP or DOWN to cycle through subgroups until the desired subgroup appears on the screen. Press the MESSAGE RIGHT or ENTER key to enter a subgroup.

■ **PASSCODE** |▷|

5. Each sub-group has one or more associated setpoint messages. Press the MESSAGE UP or DOWN keys to scroll through setpoint messages until the desired message appears.

**ENTER PASSCODE
FOR ACCESS:**

6. The majority of setpoints are changed by pressing the VALUE keys until the desired value appears, and then pressing ENTER. Numeric setpoints may also be entered through the numeric keys (including decimals). If the entered setpoint is out of range, the original setpoint value reappears. If the entered setpoint is out of step, an adjusted value will be stored (e.g. 101 for a setpoint that steps 95, 100, 105 is stored as 100). If a mistake is made entering the new value, pressing ESCAPE returns the setpoint to its original value. Text editing is a special case described in detail in *Entering alphanumeric text* on page 4–5. Each time a new setpoint is successfully stored, a message will flash on the display stating **NEW SETPOINT HAS BEEN STORED**.
7. Press the 4, 8, and 9 keys, then press ENTER. The following flash message is displayed:

**NEW SETPOINT
HAS BEEN STORED**

and the display returns to:

**SETPOINT ACCESS:
PERMITTED**

8. Press ESCAPE or MESSAGE LEFT to exit the subgroup. Pressing ESCAPE or MESSAGE LEFT numerous times will always return the cursor to the top of the page.

4.1.8 Diagnostic Messages

Diagnostic messages are automatically displayed for any active conditions in the relay such as trips, alarms, or asserted logic inputs. These messages provide a summary of the present state of the relay. The Message LED flashes when there are diagnostic messages available; press the MENU key until the relay displays **TARGET MESSAGES**, then press the MESSAGE RIGHT key, followed by the MESSAGE DOWN key, to scroll through the messages.

4.1.9 Flash Messages

Flash messages are warning, error, or general information messages displayed in response to certain key presses. The length of time these messages remain displayed can be programmed in **S1 745 SETUP ▷▽ PREFERENCES ▷▽ DEFAULT MESSAGE CYCLE TIME**. The factory default flash message time is 4 seconds. For additional information and a complete list of flash messages, refer to *Flash Messages* on page 6–27.

4.2 EnerVista Software Interface

4.2.1 Overview

The front panel provides local operator interface with a liquid crystal display. The EnerVista 745 Setup software provides a graphical user interface (GUI) as one of two human interfaces to a 745 device. The alternate human interface is implemented via the device's faceplate keypad and display (see the first section in this chapter).

The EnerVista 745 Setup software provides a single facility to configure, monitor, maintain, and trouble-shoot the operation of relay functions, connected over serial communication networks. It can be used while disconnected (i.e. off-line) or connected (i.e. on-line) to a 745 device. In off-line mode, settings files can be created for eventual downloading to the device. In on-line mode, you can communicate with the device in real-time.

This no-charge software, provided with every 745 relay, can be run from any computer supporting Microsoft Windows® 95 or higher. This chapter provides a summary of the basic EnerVista 745 Setup software interface features. The EnerVista 745 Setup help file provides details for getting started and using the software interface.

With the EnerVista 745 Setup running on your PC, it is possible to

- Program and modify setpoints
- Load/save setpoint files from/to disk
- Read actual values and monitor status
- Perform waveform capture and log data
- Plot, print, and view trending graphs of selected actual values
- Download and playback waveforms
- Get help on any topic

4.2.2 Hardware

Communications from the EnerVista 745 Setup to the 745 can be accomplished three ways: RS232, RS485, and Ethernet communications. The following figures below illustrate typical connections for RS232, RS485, and Ethernet communications.



FIGURE 4-2: Communications using the front RS232 port

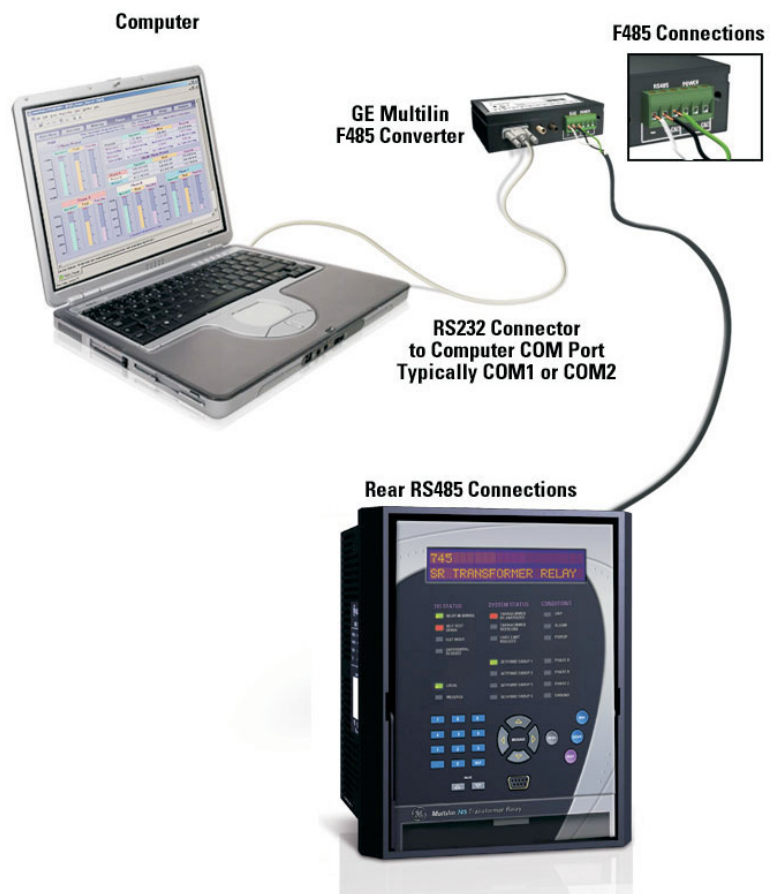
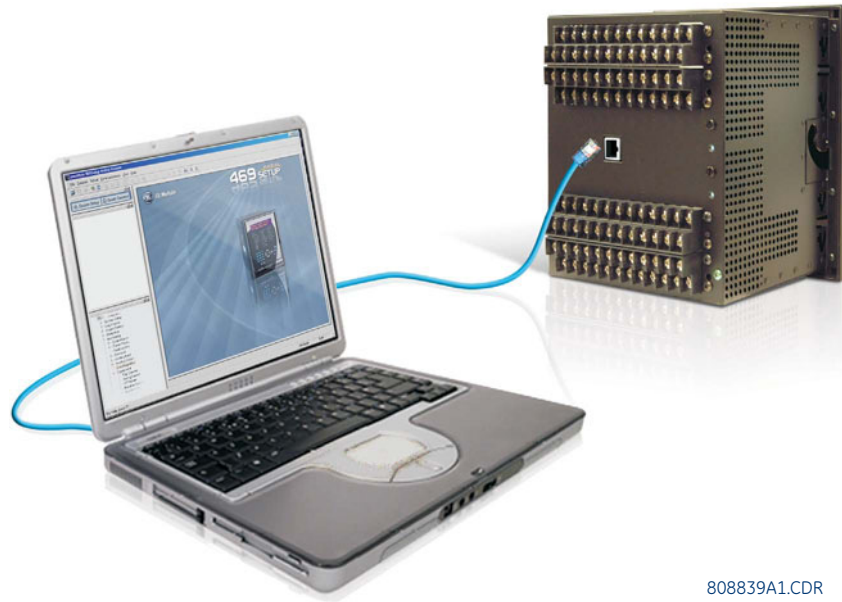

FIGURE 4-3: Communications using rear RS485 port



808839A1.CDR

FIGURE 4–4: Communications using rear Ethernet port

4.2.3 Installing the EnerVista 745 Setup Software

The following minimum requirements must be met for the EnerVista 745 Setup software to operate on your computer.

- Pentium class or higher processor (Pentium II 400 MHz or better recommended)
- Microsoft Windows 98, 98SE, NT 4.0 (SP4 or higher), 2000, XP
- Internet Explorer version 4.0 or higher (required libraries)
- 128 MB of RAM (256 MB recommended)
- Minimum of 200 MB hard disk space

A list of qualified modems for serial communications is shown below:

- US Robotics external 56K Faxmodem 5686
- US Robotics external Sportster 56K X2
- PCTEL 2304WT V.92 MDC internal modem

After ensuring these minimum requirements, use the following procedure to install the EnerVista 745 Setup software from the enclosed GE EnerVista CD.

- ▷ Insert the GE EnerVista CD into your CD-ROM drive.
- ▷ Click the **Install Now** button and follow the installation instructions to install the no-charge EnerVista software on the local PC.
- ▷ When installation is complete, start the EnerVista Launchpad application.

- ▶ Click the **IED Setup** section of the **Launch Pad** window.



- ▶ In the EnerVista Launch Pad window, click the **Add Product** button.
- ▶ Select the **745 Transformer Protection System** from the Install Software window as shown below.
- ▶ Select the **Web** option to ensure the most recent software release, or select **CD** if you do not have a web connection, then
- ▶ Click the **Add Now** button to list software items for the 745.

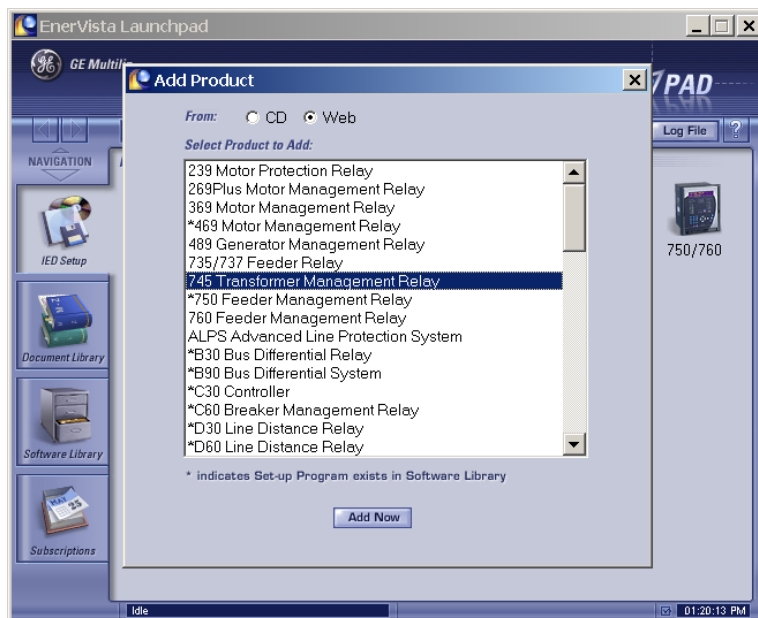

EnerVista Launchpad will obtain the latest installation software from the Web or CD and automatically start the installation process. A status window with a progress bar will be shown during the downloading process.

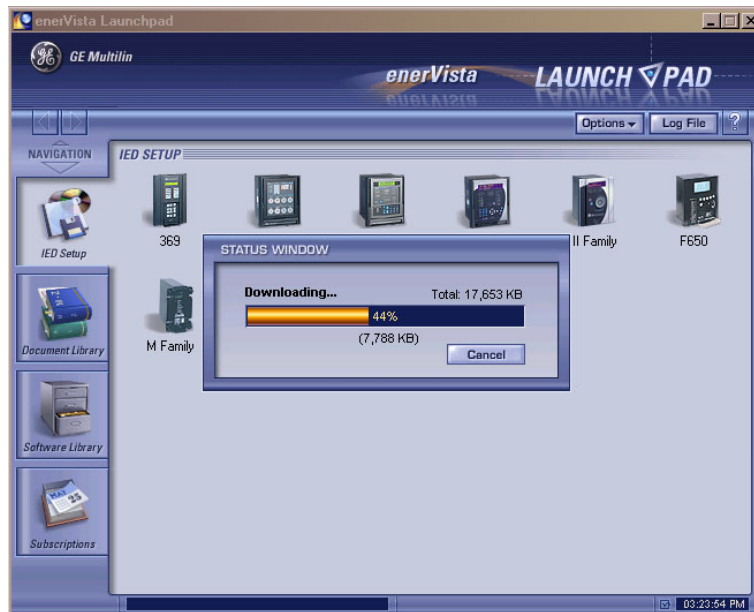

- ▷ Select the complete path, including the new directory name, where the EnerVista 745 Setup software will be installed.
- ▷ Click on **Next** to begin the installation.
The files will be installed in the directory indicated and the installation program will automatically create icons and add EnerVista 745 Setup software to the Windows start menu.
- ▷ Click **Finish** to end the installation.
The 745 device will be added to the list of installed IEDs in the EnerVista Launchpad window, as shown below.

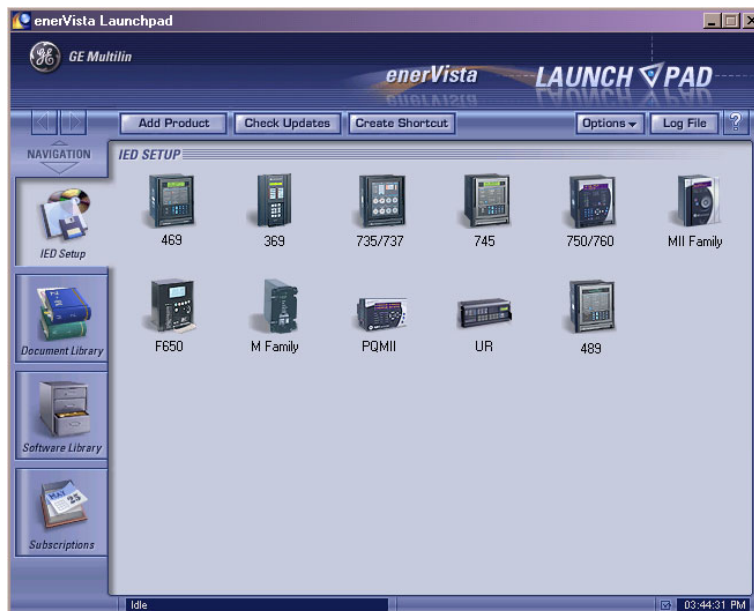

4.3 Connecting EnerVista 745 Setup to the relay

4.3.1 Configuring serial communications

Before starting, verify that the serial cable is properly connected to either the RS232 port on the front panel of the device (for RS232 communications) or to the RS485 terminals on the back of the device (for RS485 communications).

This example demonstrates an RS232 connection. For RS485 communications, the GE Multilin F485 converter will be required. Refer to the F485 manual for additional details. To configure the relay for Ethernet communications, see *Configuring Ethernet communications* on page 4–15.

- ▷ Install and start the latest version of the EnerVista 745 Setup software (available from the GE EnerVista CD).
See the previous section for the installation procedure.
- ▷ Click on the **Device Setup** button to open the Device Setup window.
- ▷ Click the **Add Site** button to define a new site.
- ▷ Enter the desired site name in the **Site Name** field.
If desired, a short description of the site can also be entered along with the display order of devices defined for the site. In this example, we will use “Transformer Station 1” as the site name.
- ▷ Click the **OK** button when complete.

The new site will appear in the upper-left list in the EnerVista 745 Setup window.

- ▷ Click the **Add Device** button to define the new device.
- ▷ Enter the desired name in the **Device Name** field and a site description (optional).

- ▷ Select **Serial** from the Interface drop-down list.
This will display a number of interface parameters that must be entered for proper RS232 functionality.

- Enter the **slave address** and **COM port** values (from the **S1 745 SETUP ▷ SERIAL PORTS** menu) in the Slave Address and COM Port fields.
- Enter the physical communications parameters (baud rate and parity setpoints) in their respective fields.
Note that when communicating to the relay from the front port, the default communications settings are a baud rate of 9600, with slave address of 1, no parity, 8 bits, and 1 stop bit. **These values cannot be changed.**

- ▷ Click the **Read Order Code** button to connect to the 745 device and upload the order code.
If a communications error occurs, ensure that the 745 serial communications values entered in the previous step correspond to the relay setting values.
- ▷ Click **OK** when the relay order code has been received.
The new device will be added to the Site List window (or Online window) located in the top left corner of the main EnerVista 745 Setup window.

The 745 site device has now been configured for serial communications. Proceed to *Connecting to the Relay* on page 4-17 to begin communications.

4.3.2 Using the Quick Connect Feature

The **Quick Connect** button can be used to establish a fast connection through the front panel RS232 port of a 745 relay. The following window will appear when the **Quick Connect** button is pressed:

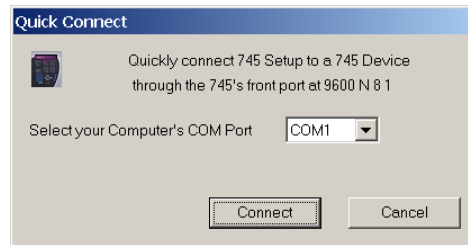

As indicated by the window, the quick connect feature quickly connects the EnerVista 745 Setup software to a 745 front port with the following settings: 9600 baud, no parity, 8 bits, 1 stop bit. Select the PC communications port connected to the relay and press the **Connect** button.

The EnerVista 745 Setup software will display a window indicating the status of communications with the relay. When connected, a new Site called "Quick Connect" will appear in the Site List window. *The properties of this new site cannot be changed.*

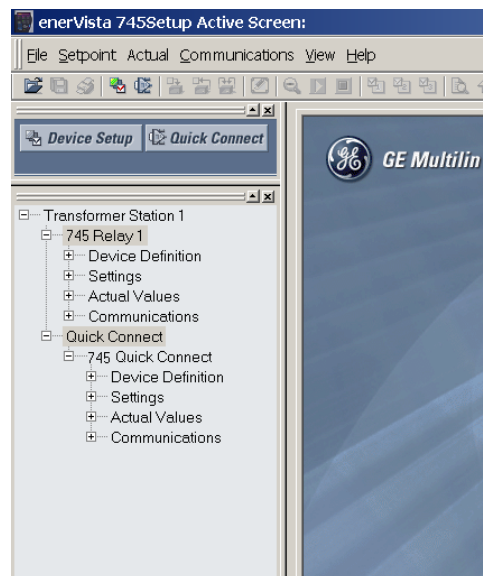

The 745 site device has now been configured via the Quick Connect feature for serial communications. Proceed to *Connecting to the Relay* on page 4–17 to begin communications.

4.3.3 Configuring Ethernet communications

Before starting, verify that the Ethernet cable is properly connected to the RJ45 Ethernet port.

- ▷ Install and start the latest version of the EnerVista 745 Setup software (available from the GE EnerVista CD).
See the previous section for the installation procedure.

- ▷ Click on the **Device Setup** button to open the device setup window.
- ▷ Click the **Add Site** button to define a new site.
- ▷ Enter the desired site name in the **Site Name** field.
If desired, a short description of the site can also be entered along with the display order of devices defined for the site. In this example, we will use “Transformer Station 1” as the site name.
- ▷ Click the **OK** button when complete.

The new site will appear in the upper-left list in the EnerVista 745 Setup window.

- ▷ Click the **Add Device** button to define the new device.
- ▷ Enter the desired name in the **Device Name** field and a description (optional) of the site.
- ▷ Select **Ethernet** from the Interface drop-down list.
This will display a number of interface parameters that must be entered for proper Ethernet functionality.

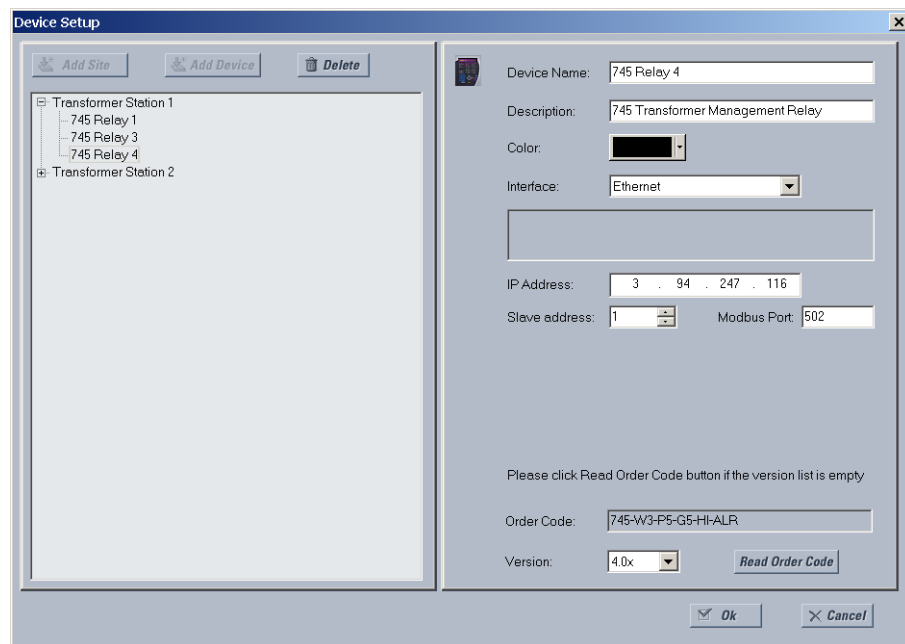

- ▷ Enter the **IP address** assigned to the 745 relay.
- ▷ Enter the **slave address** and **Modbus port values** (from the [S1 745 SETUP ▷ COMMUNICATIONS](#) menu) in the **Slave Address** and **Modbus Port** fields.
- ▷ Click the **Read Order Code** button to connect to the 745 device and upload the order code.
If a communications error occurs, ensure that the 745 Ethernet communications values entered in the previous step correspond to the relay values.
- ▷ Click **OK** when the relay order code has been received.
The new device will be added to the site list window (or online window) located in the top left corner of the main EnerVista 745 Setup window.

The 745 Site Device has now been configured for Ethernet communications. Proceed to the following section to begin communications.

4.3.4 Connecting to the Relay

Now that the communications parameters have been properly configured, the user can easily connect to the relay.

- ▷ Expand the Site list by double clicking on the site name or clicking on the «+» box to list the available devices for the given site (for example, in the “Transformer Station 1” site shown below).

Desired device trees can be expanded by clicking the «+» box. The following list of headers is shown for each device:

- Device definitions
- Settings
- Actual values
- Commands
- Communications
- ▷ Expand the **Settings > Relay Setup** list item.
- ▷ Double click on Front Panel to open the Front Panel settings window as shown below:

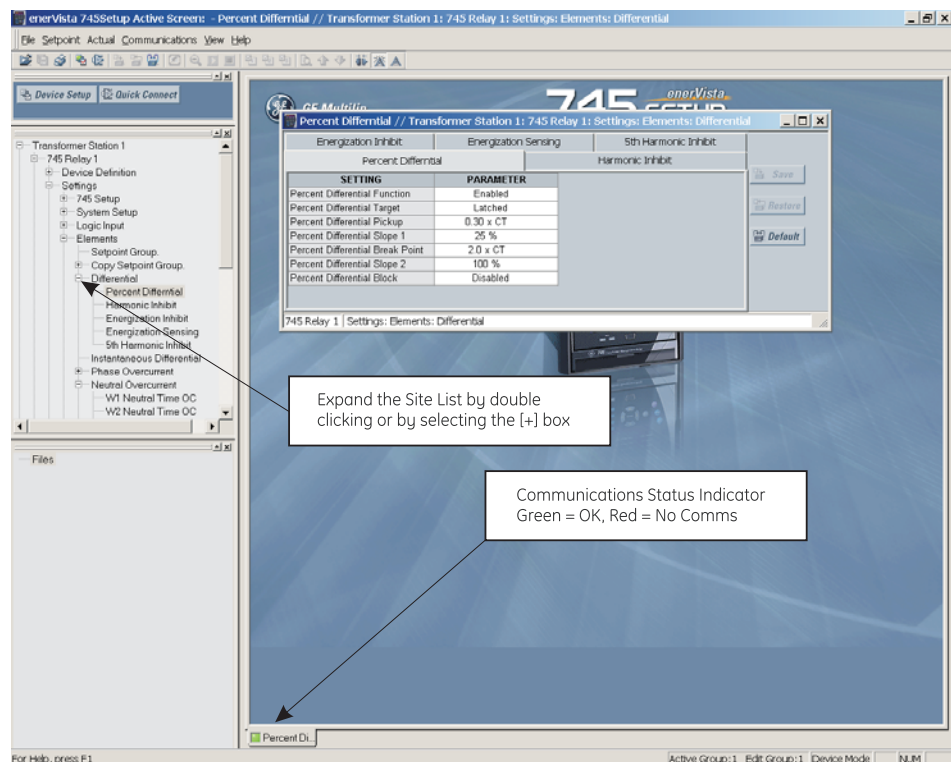

FIGURE 4-5: Main window after connection

The Front Panel settings window will open with a corresponding status indicator on the lower left of the EnerVista 745 Setup window.

If the status indicator is red, verify that the serial cable is properly connected to the relay, and that the relay has been properly configured for communications (steps described earlier).

The front panel setpoints can now be edited, printed, or changed according to user specifications. Other setpoint and commands windows can be displayed and edited in a similar manner. Actual values windows are also available for display. These windows can be locked, arranged, and resized at will.



Refer to the EnerVista 745 Setup help file for additional information about the using the software.

4.4 Working with Setpoints and Setpoint Files

4.4.1 Engaging a Device

The EnerVista 745 Setup software may be used in on-line mode (relay connected) to directly communicate with a 745 relay. Communicating relays are organized and grouped by communication interfaces and into sites. Sites may contain any number of relays selected from the SR or UR product series.

4.4.2 Entering Setpoints

The system setup page will be used as an example to illustrate the entering of setpoints. In this example, we will be changing the current sensing setpoints.

- ▷ Establish communications with the relay.
- ▷ Select the **Setpoint > System Setup > Transformer** menu item. This can be selected from the device setpoint tree or the main window menu bar.
- ▷ Select the **LOAD LOSS AT RATED LOAD** setpoint by clicking anywhere in the parameter box. This will display three arrows: two to increment/decrement the value and another to launch the numerical calculator.

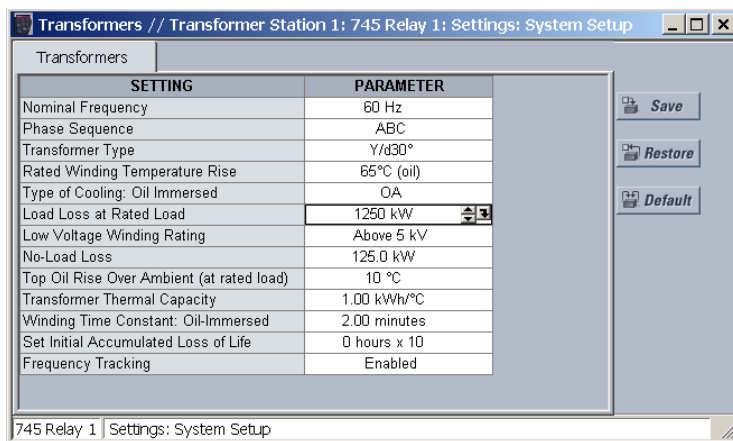

- ▶ Click the arrow at the end of the box to display a numerical keypad interface that allows the user to enter a value within the setpoint range displayed near the top of the keypad:

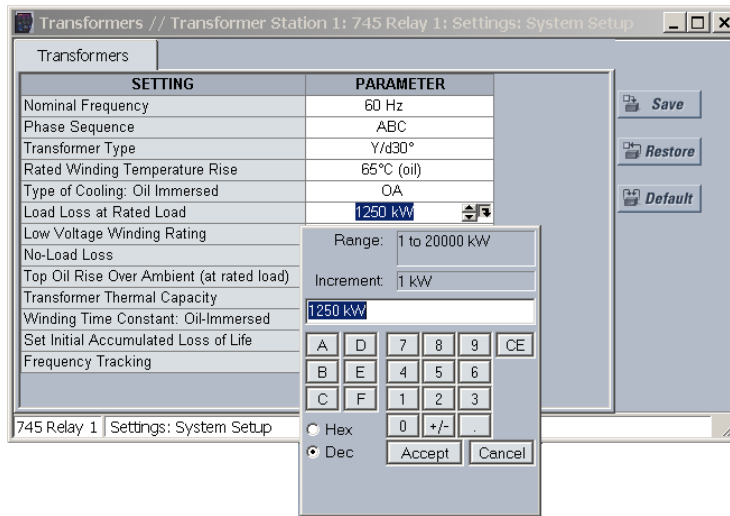

- ▶ Click **Accept** to exit from the keypad and keep the new value.
- ▶ Click on **Cancel** to exit from the keypad and retain the old value.

For setpoints requiring non-numerical pre-set values (e.g. **PHASE SEQUENCE**),

- ▶ Click anywhere within the setpoint value box to display a drop-down selection menu arrow.
- ▶ Click on the arrow to select the desired setpoint.

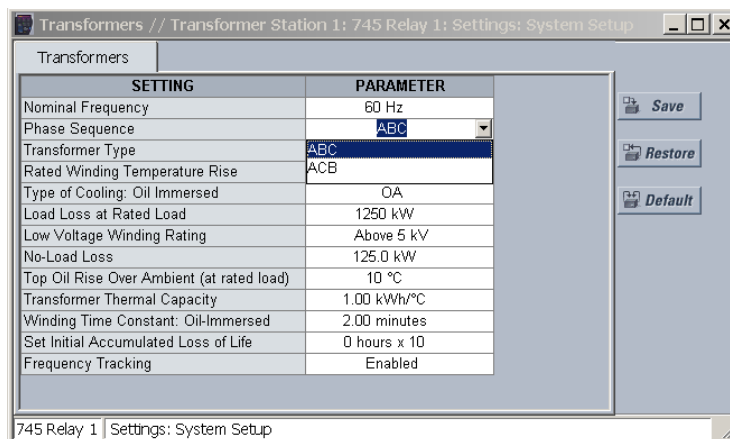

For setpoints requiring an alphanumeric text string (e.g. message scratchpad messages),

- ▶ Enter the value directly within the **setpoint value box**.
- ▶ In any settings window, click on **Save** to save the values into the 745.
- ▶ Click **Yes** to accept any changes.
- ▶ Click **No**, and then **Restore** to retain previous values and exit.

4.4.3 File Support

Opening any EnerVista 745 Setup file will automatically launch the application or provide focus to the already opened application. If the file is a settings file (has a '745' extension) which had been removed from the Settings List tree menu, it will be added back to the Settings List tree.

New files will be automatically added to the tree, which is sorted alphabetically with respect to settings file names.

4.4.4 Using Setpoints Files

4.4.4.1 Overview

The EnerVista 745 Setup software interface supports three ways of handling changes to relay settings:

- In *off-line* mode (relay disconnected) to create or edit relay settings files for later download to communicating relays.
- Directly modifying relay settings while *connected* to a communicating relay, then saving the settings when complete.
- Creating/editing settings files while *connected* to a communicating relay, then saving them to the relay when complete.

Settings files are organized on the basis of file names assigned by the user. A settings file contains data pertaining to the following types of relay settings:

- Device definition
- Product setup
- System setup
- Logic inputs
- Protection elements
- Outputs
- Relay testing
- User memory map setting tool

Factory default values are supplied and can be restored after any changes.

The EnerVista 745 Setup display relay setpoints with the same hierarchy as the front panel display. For specific details on setpoints, refer to Chapter 5.

4.4.4.2 Downloading and Saving Setpoints Files

Setpoints must be saved to a file on the local PC before performing any firmware upgrades. Saving setpoints is also highly recommended before making any setpoint changes or creating new setpoint files.

The EnerVista 745 Setup window, setpoint files are accessed in the Settings List control bar window or the Files window. Use the following procedure to download and save setpoint files to a local PC.

- ▷ Ensure that the site and corresponding device(s) have been properly defined and configured as shown in *EnerVista Software Interface* on page 4–8.
- ▷ Select the desired device from the site list.
- ▷ Select the **File > Read Settings from Device** menu item to obtain settings information from the device.

After a few seconds of data retrieval, the software will request the name and destination path of the setpoint file. The corresponding file extension will be automatically assigned.

- ▷ Press **Save** to complete the process.
A new entry will be added to the tree, in the File pane, showing path and file name for the setpoint file.

4.4.4.3 Adding Setpoints Files to the Environment

The EnerVista 745 Setup software provides the capability to review and manage a large group of setpoint files. Use the following procedure to add a new or existing file to the list.

- ▷ In the files pane, right-click on **Files**.
- ▷ Select the **Add Existing Setting File** item as shown:

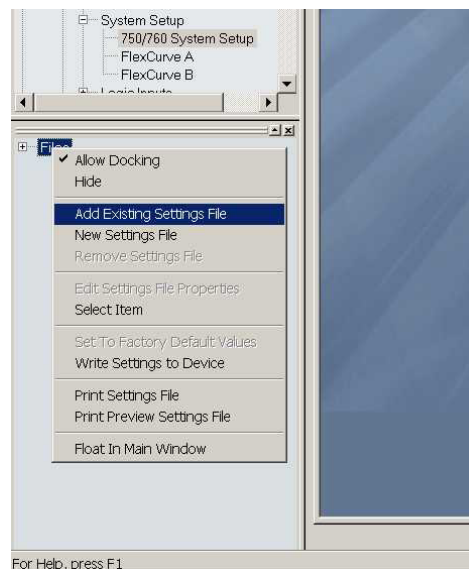

The Open dialog box will appear, prompting for a previously saved setpoint file. As for any other Windows® application,

- ▷ Browse for the file to add.
- ▷ Click **Open**.
The new file and complete path will be added to the file list.

4.4.4.4 Creating a New Setpoint File

The EnerVista 745 Setup software allows the user to create new setpoint files independent of a connected device. These can be uploaded to a relay at a later date. The following procedure illustrates how to create new setpoint files.

1. In the File pane, right click on 'File' and select the **New Settings File** item. The EnerVista 745 Setup software displays the following box will appear, allowing for the configuration of the setpoint file for the correct firmware version. It is important to define the correct firmware version to ensure that setpoints not available in a particular version are not downloaded into the relay.

- ▷ Select the software **Revision** for the new setpoint file.
- ▷ Configure the **Installed Options** as shown.
- ▷ For future reference, enter some useful information in the **Description** box to facilitate the identification of the device and the purpose of the file.
- ▷ To select a file name and path for the new file, click the button beside the **File Name** box.
- ▷ Select the file name and path to store the file, or select any displayed file name to update an existing file.
All 745 setpoint files should have the extension '745' (for example, 'motor1.745').
- ▷ Click **Save** and **OK** to complete the process.
Once this step is completed, the new file, with a complete path, will be added to the EnerVista 745 Setup software environment.

4.4.4.5 Upgrading Setpoint Files to a New Revision

It is often necessary to upgrade the revision code for a previously saved setpoint file after the 745 firmware has been upgraded (for example, this is required for firmware upgrades). This is illustrated in the following procedure.

- ▷ Establish communications with the 745 relay.

- ▷ Select the **Actual > Product Info** menu item and record the Software Revision identifier of the relay firmware as shown below.

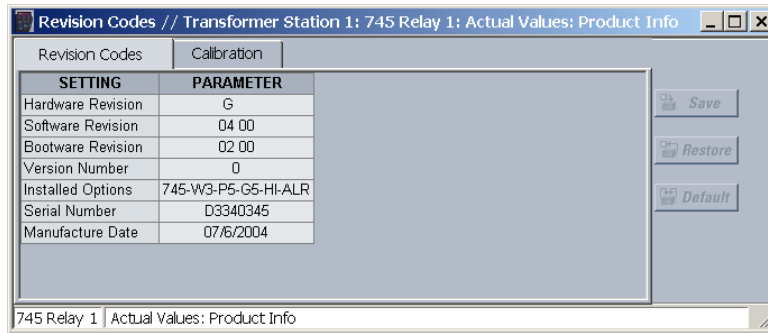

- ▷ Load the setpoint file to be upgraded into the EnerVista 745 Setup environment as described in *Adding Setpoints Files to the Environment* on page 4–22.
- ▷ In the **File** pane, select the saved setpoint file.
- ▷ From the main window menu bar, select the **File > Properties** menu item and note the version code of the setpoint file. If this version (e.g. 4.0X shown below) is different than the **Software Revision** code noted in step 2, select a **New File Version** that matches the software revision code from the pull-down menu. For example, if the software revision is 2.80 and the current setpoint file revision is 4.00, change the setpoint file revision to “4.0X”, as shown below.

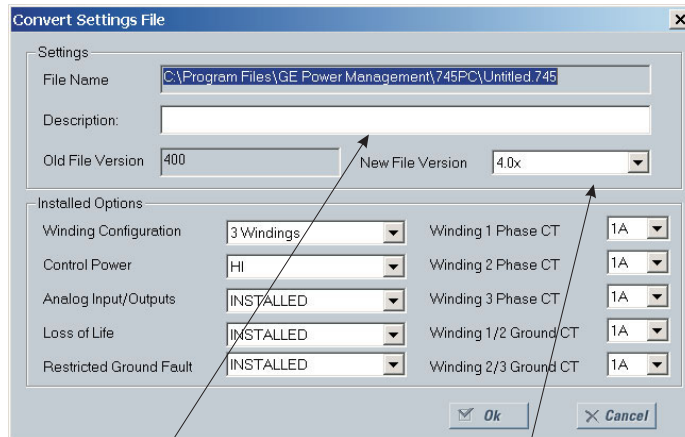

Enter any special comments about the setpoint file here.

Select the desired setpoint version from this menu. The 4.0x indicates versions 4.00, 4.01, 4.02, etc.

- ▷ When complete, click **Convert** to convert the setpoint file to the desired revision. A dialog box will request confirmation. See *Loading Setpoints from a File* on page 4–26 for instructions on loading this setpoint file into the 745.

4.4.4.6 Printing Setpoints and Actual Values

The EnerVista 745 Setup software allows the user to print partial or complete lists of setpoints and actual values. Use the following procedure to print a list of setpoints:

- ▷ Select a previously saved setpoints file in the File pane or establish communications with a 745 device.
- ▷ From the main window, select the **File > Print Settings** menu item. The Print/Export Options dialog box will appear.
- ▷ Select **Settings** in the upper section and select either **Include All Features** (for a complete list) or **Include Only Enabled Features** (for a list of only those features which are currently used) in the filtering section.
- ▷ Click **OK**.



The process for **File > Print Preview Settings** is identical to the steps above.

Setpoints lists can be printed in the same manner by right clicking on the desired file (in the file list) or device (in the device list) and selecting the **Print Device Information** or **Print Settings File** options.

A complete list of actual values can also be printed from a connected device with the following procedure:

- ▷ Establish communications with the desired 745 device.
- ▷ From the main window, select the **File > Print Settings** menu item. The Print/Export Options dialog box will appear.
- ▷ Select **Actual Values** in the upper section and select either **Include All Features** (for a complete list) or **Include Only Enabled Features** (for a list of only those features which are currently used) in the filtering section.
- ▷ Click **OK**.

Actual values lists can be printed in the same manner by right clicking on the desired device (in the device list) and selecting the **Print Device Information** option.

4.4.4.7 Loading Setpoints from a File



An error message will occur when attempting to download a setpoint file with a revision number that does not match the relay firmware. If the firmware has been upgraded since saving the setpoint file, see *Upgrading Setpoint Files to a New Revision* on page 4–23 for instructions on changing the revision number of a setpoint file.

The following procedure illustrates how to load setpoints from a file. Before loading a setpoints file, it must first be added to the EnerVista 745 Setup environment as described in *Adding Setpoints Files to the Environment* on page 4–22.

- ▷ Select the previously saved setpoints file from the File pane of the EnerVista 745 Setup software main window.
- ▷ Select the **File > Properties** menu item and verify that the corresponding file is fully compatible with the hardware and firmware version of the target relay.
If the versions are not identical, see *Upgrading Setpoint Files to a New Revision* on page 4–23 for details on changing the setpoints file version.
- ▷ Right-click on the selected file and select the **Write Settings to Device** item.
If the relay is currently in-service, the EnerVista 745 Setup software will generate a warning message reminding the user to remove the relay from service before attempting to load setpoints.
- ▷ Select the target relay from the list of devices shown.
- ▷ Click **Send**.
If there is an incompatibility, an error will occur informing the user of incompatibilities:

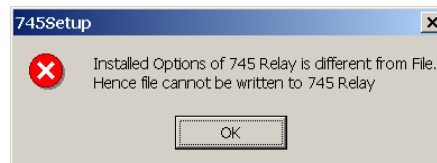

If there are no incompatibilities between the target device and the Setpoints file, the data will be transferred to the relay. An indication of the percentage completed will be shown in the bottom of the main menu.

4.5 Upgrading Relay Firmware

4.5.1 Description

To upgrade the 745 firmware, follow the procedures listed in this section. Upon successful completion of this procedure, the 745 will have new firmware installed with the original setpoints.

The latest firmware files are available from the GE Multilin website at <http://www.GEmultilin.com>.

4.5.2 Saving Setpoints to a File

Before upgrading firmware, it is very important to save the current 745 settings to a file on your PC. After the firmware has been upgraded, it will be necessary to load this file back into the 745.

Refer to *Downloading and Saving Setpoints Files* on page 4–21 for details on saving relay setpoints to a file.

4.5.3 Loading New Firmware

Loading new firmware into the 745 flash memory is accomplished as follows:

- ▷ Connect the relay to the local PC and save the setpoints to a file as shown in *Downloading and Saving Setpoints Files* on page 4–21.
- ▷ Select the **Communications > Update Firmware** menu item. The following warning message will appear.

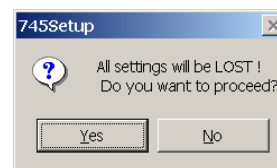

- ▷ Select **Yes** to proceed or **No** to cancel the process. *Do not proceed unless you have saved the current setpoints*

An additional message will be displayed to ensure the PC is connected to the relay front port, as the 745 cannot be upgraded via the rear RS485 ports.

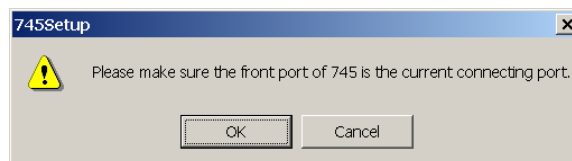

The EnerVista 745 Setup software will request the new firmware file.

- ▷ Locate the firmware file to load into the 745.
The firmware filename has the following format:

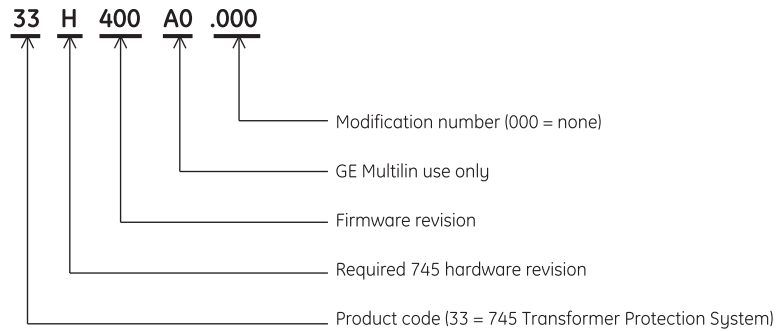

Figure 4-1: Firmware file format

The EnerVista 745 Setup software automatically lists all filenames beginning with '33'.

- ▷ Select the appropriate file and click **OK** to continue.

The software will prompt with another Upload Firmware Warning window. This will be the final chance to cancel the firmware upgrade before the flash memory is erased.

- ▷ Click **Yes** to continue or **No** to cancel the upgrade.

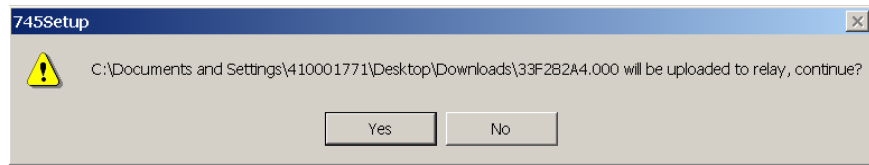

The EnerVista 745 Setup software now prepares the 745 to receive the new firmware file. The 745 will display a message indicating that it is in Upload Mode. While the file is being loaded into the 745, a status box appears showing how much of the new firmware file has been transferred and how much is remaining, as well as the upgrade status. The entire transfer process takes approximately five minutes.

The EnerVista 745 Setup software will notify the user when the 745 has finished loading the file.

- ▷ Carefully read any displayed messages and click **OK** to return the main screen.



Cycling power to the relay is recommended after a firmware upgrade.

After successfully updating the 745 firmware, the relay will not be in service and will require setpoint programming. To communicate with the relay, the following settings will have to be manually programmed.

- SLAVE ADDRESS**
- COM1/COM2/FRONT BAUD RATE**
- COM1/COM2/FRONT PARITY** (if applicable)

When communications is established, the saved setpoints must be reloaded back into the relay. See *Loading Setpoints from a File* on page 4-26 for details.

Modbus addresses assigned to firmware modules, features, settings, and corresponding data items (i.e. default values, minimum/maximum values, data type, and item size) may change slightly from version to version of firmware.

The addresses are rearranged when new features are added or existing features are enhanced or modified. The **EEPROM DATA ERROR** message displayed after upgrading/downgrading the firmware is a resettable, self-test message intended to inform users that the Modbus addresses have changed with the upgraded firmware. This message does not signal any problems when appearing after firmware upgrades.

4.6 Advanced EnerVista 745 Setup Features

4.6.1 Triggered Events

While the interface is in either on-line or off-line mode, data generated by triggered specified parameters can be viewed and analyzed via one of the following:

- **Event recorder:** The event recorder captures contextual data associated with the last 256 events, listed in chronological order from most recent to the oldest.
- **Oscillography:** The oscillography waveform traces and digital states provide a visual display of power system and relay operation data captured during specific triggered events.

4.6.2 Waveform Capture (trace memory)

The EnerVista 745 Setup software can be used to capture waveforms (or view trace memory) from the 745 relay at the instance of a trip. A maximum of 128 cycles can be captured and the trigger point can be adjusted to anywhere within the set cycles. A maximum of 32 waveforms can be buffered (stored) with the buffer/cycle trade-off.

The following waveforms can be captured:

- Phase A, B, and C currents (I_a , I_b , and I_c)
- Differential A, B, and C currents (I_{diffa} , I_{diffb} , and I_{diffc})
- Ground currents (I_g)
- Phase A-N, B-N, and C-N voltages (V_a , V_b , and V_c)
- Digital data for output relays and contact input states

- ▷ With EnerVista 745 Setup running and communications established, select the **Actual > Waveform Capture** menu item to open the waveform capture setup window:

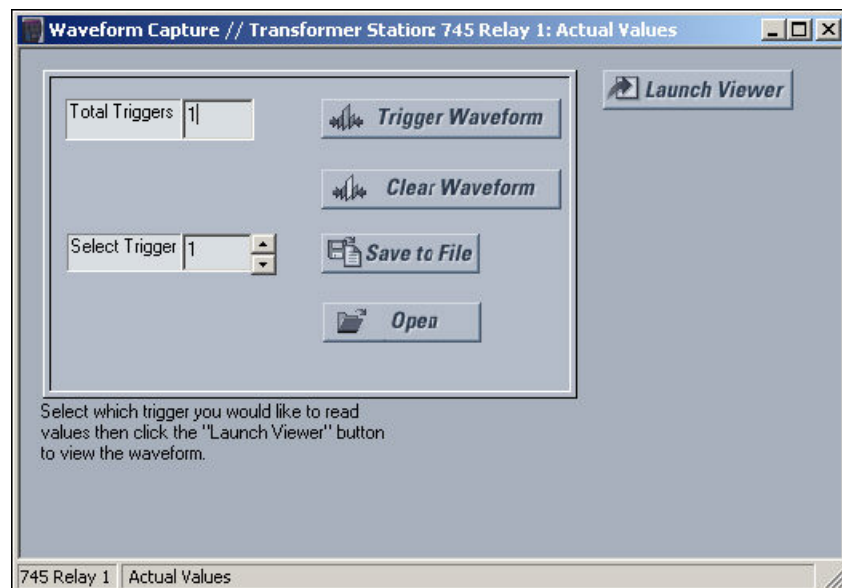

- ▷ Click on **Trigger Waveform** to trigger a waveform capture.

The waveform file numbering starts with the number zero in the 745; therefore, the maximum trigger number will always be one less than the total number triggers available.

- ▶ Click on the **Save to File** button to save the selected waveform to the local PC.

A new window will appear requesting for file name and path.

The file is saved as a COMTRADE file, with the extension 'CFG'. In addition to the COMTRADE file, two other files are saved. One is a CSV (comma delimited values) file, which can be viewed and manipulated with compatible third-party software. The other file is a DAT File, required by the COMTRADE file for proper display of waveforms.

- ▶ To view a previously saved COMTRADE file, click the **Open** button and select the corresponding COMTRADE file.
- ▶ To view the captured waveforms, click the **Launch Viewer** button. A detailed waveform capture window will appear as shown below:

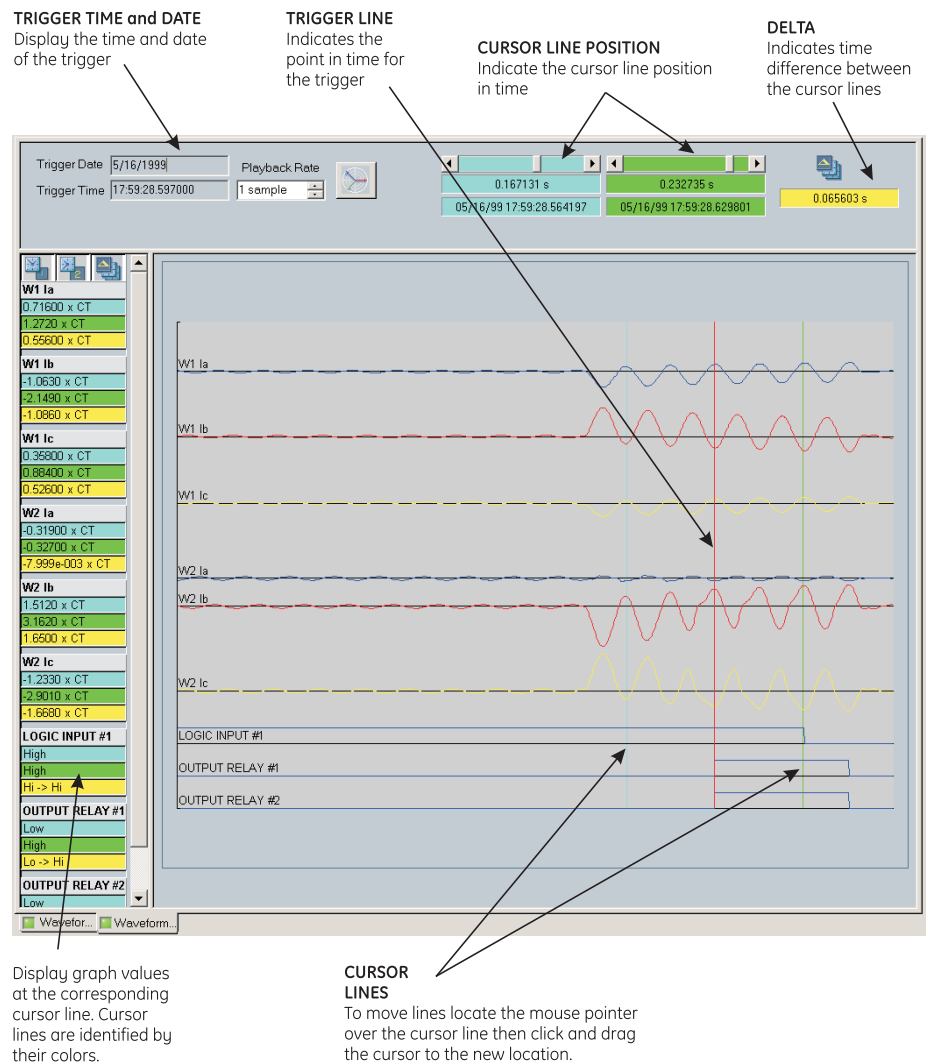
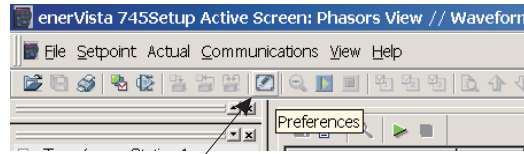

FIGURE 4-6: Waveform capture window attributes

The red vertical line indicates the trigger point of the relay.

The date and time of the trip is displayed at the top left corner of the window. To match the captured waveform with the event that triggered it, make note of the time and date shown in the graph. Then, find the event that matches the same time and date in the event recorder. The event record will provide additional information on the cause and the system conditions at the time of the event. Additional information on how to download and save events is shown in *Event Recorder* on page 4-35.

- ▷ From the window main menu bar, press the **Preference** button to open the Comtrade Setup page to change the graph attributes.



Preference button

The following window will appear:

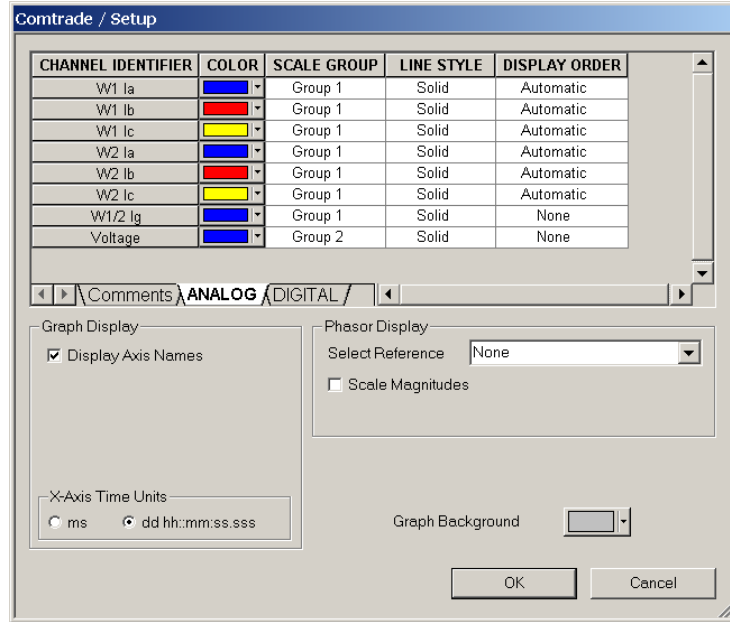

- ▷ Change the Color of each graph as desired, and select other options as required, by checking the appropriate boxes.
- ▷ Click **OK** to store these graph attributes, and to close the window.

The Waveform Capture window will reappear with the selected graph attributes available for use.

4.6.3 Trending (data logger)

The trending or data logger feature is used to sample and record up to eight actual values at an interval defined by the user. Several parameters can be trended and graphed at sampling periods ranging from 1 second up to 1 hour. The parameters which can be trended by the EnerVista 745 Setup software are:

- **Currents/voltages:**
 - I_a , I_b , I_c , I_n , and I_g currents for windings 1, 2, and 3
 - Positive-, negative-, and zero-sequence currents for windings 1, 2, and 3
 - I_a , I_b , and I_c differential and restraint currents
 - System frequency
 - Frequency decay rate
 - **Harmonics:**
 - Total harmonic distortion (THD)
 - Harmonic derating factor
 - **Temperature:**
 - Ambient temperature
 - Hottest-spot winding temperature
 - RTDs 1 through 12
 - **Demand:**
 - Current demand for Windings 1, 2, and 3
 - **Others:**
 - Analog inputs 1, 2, 3, and 4
 - Accumulated loss-of-life
 - Aging factor
 - Tap changer position
- ▷ With EnerVista 745 Setup running and communications established, select the **Actual Values > Trending** menu item to open the trending window.

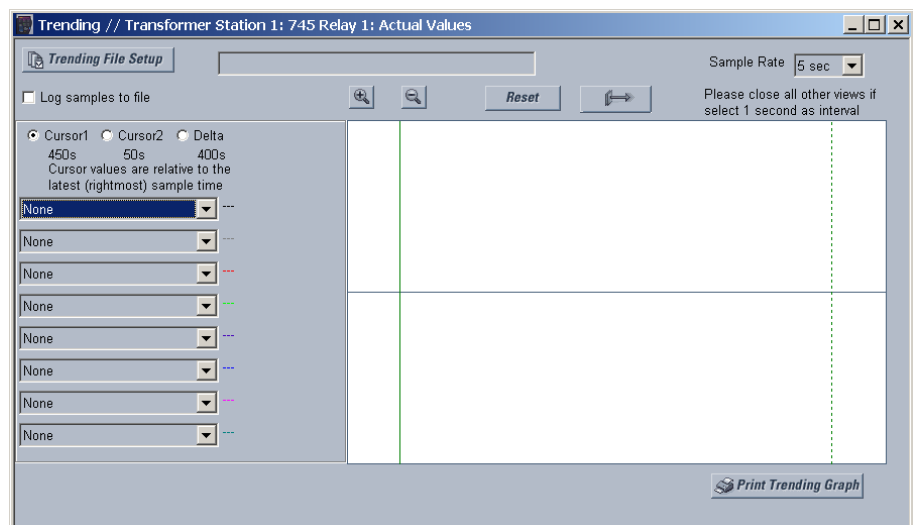

- ▷ To prepare for new trending, select **Stop** to stop the data logger and **Reset** to clear the screen.
- ▷ Select the graphs to be displayed through the pull-down menu beside each channel description.
- ▷ Select the sample rate through the pull-down menu.

If you want to save the information captured by trending,

- ▷ Check the box besides **Log Samples to File**.

The following dialog box will appear requesting for file name and path. The file is saved as 'csv' (comma separated values) file, which can be viewed and manipulated with compatible third-party software. Ensure that the sample rate not less than 5 seconds, otherwise some data may not get written to the file.

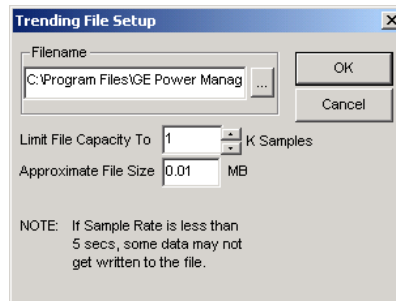

- ▷ To limit the size of the saved file, enter a number in the **Limit File Capacity To** box.

The minimum number of samples is 1000. At a sampling rate of 5 seconds (or 1 sample every 5 seconds), the file will contain data collected during the past 5000 seconds. The EnerVista 745 Setup software will automatically estimate the size of the trending file.

- ▷ Press “Run” to start the data logger.

If the **Log Samples to File** item is selected, the EnerVista 745 Setup software will begin collecting data at the selected sampling rate and will display it on the screen.

The data log will continue until the **Stop** button is pressed or until the selected number of samples is reached, whichever occurs first.

During the process of data logging, the trending screen appears as shown below.

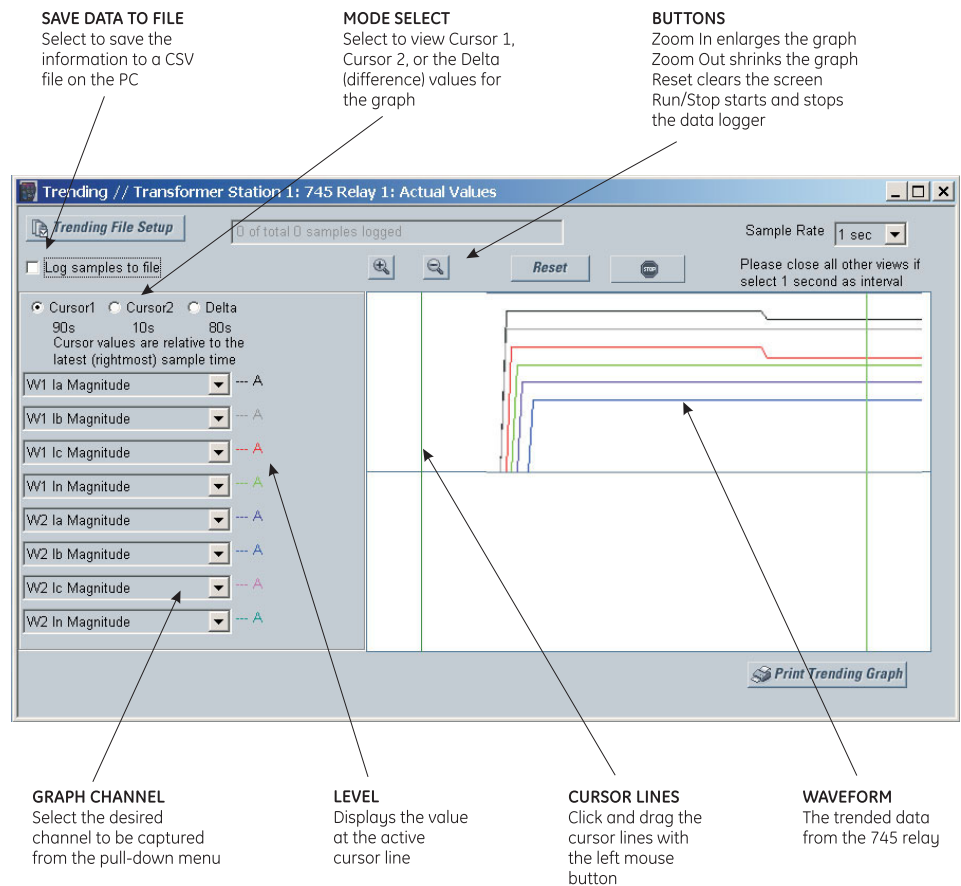

Figure 4-2: Trending screen

4.6.4 Event Recorder

The 745 event recorder can be viewed through the EnerVista 745 Setup software. The event recorder stores transformer and system information each time an event occurs. A maximum of 256 events can be stored, where E256 is the most recent event and E001 is the oldest event. E001 is overwritten whenever a new event occurs. Refer to *Event Records* on page 6–17 for additional information on the event recorder.

Use the following procedure to view the event recorder with EnerVista 745 Setup:

- ▷ With EnerVista 745 Setup running and communications established, select the **Actual > Event Recorder** item from the main menu. This displays the Event Recorder window indicating the list of recorded events, with the most current event displayed first.

EVENT LISTING
Lists the last 256 events with the most recent displayed at top of list.

EVENT SELECTION
Select an event row to view event data information, which will be displayed in the window to the right

CLEAR EVENTS
Click the Clear Events button to clear the event list from memory.

The screenshot shows the 'Event Recorder' window for 'Transformer Station 1: 745 Relay 1: Actual Values'. It features a table with columns for Event, Select, Date, Time, and Cause of Event. Below the table are buttons for 'All', 'None', and a 'Select Events' dropdown set to '18'. A detailed view of event data is shown below, with columns for 'Event Parameter' and 'Value'. On the right side, there are buttons for 'Clear Events' and 'Save Events', along with text indicating the last reset date and total events since last clear.

DEVICE ID
The events shown here correspond to this device.

EVENT PARAMETER
The event data information is related to the selected event is shown

EVENT DATA
System information as measured by the relay at the instant of the event occurrence.

SAVE EVENTS
Click the Save Events button to save the event record to the PC as a CSV file.

Figure 4-3: Event recorder window

To view detailed information for a given event and the system information at the moment of the event occurrence,

- ▷ Change the event number on the **Select Events** box.

4.6.5 Modbus User Map

The EnerVista 745 Setup software provides a means to program the 745 user map (Modbus addresses 0180h to 01F7h). Refer to GE publication GEK-106636B: 745 Communications Guide for additional information on the user map.

- ▷ Select a connected device in EnerVista 745 Setup.
- ▷ Select the **Setpoint > User Map** menu item to open the following window.

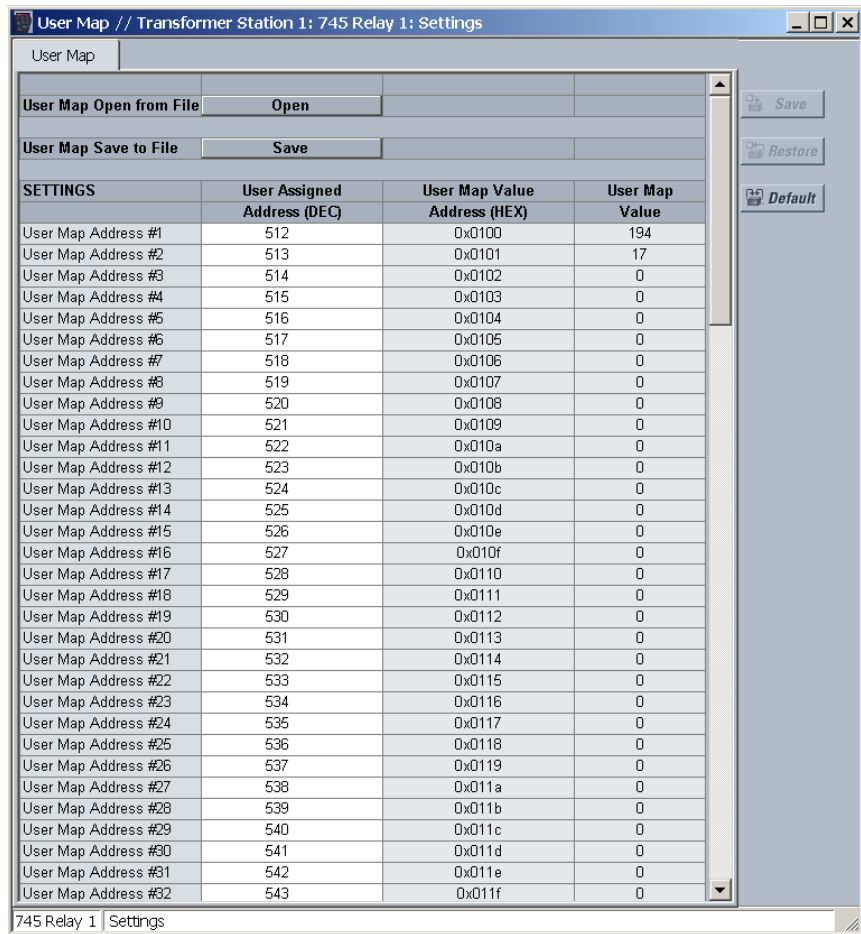

This window allows the desired addresses to be written to User Map locations. The User Map values that correspond to these addresses are then displayed.

4.6.6 Viewing Actual Values

You can view real-time relay data such as input/output status and measured parameters.

- ▷ From the main window menu bar, select **Actual Values** to open a window with tabs, each tab containing data in accordance to the following list:

1. **System status:**
 - The status of the logic inputs and virtual inputs/outputs
 - Targets.
 - The status of the output relays.
 - Any self-test errors.
2. **Metering data:**
 - Instantaneous current measurements including phase, neutral, and ground currents for each winding, along with differential, restraint, positive-sequence, negative-sequence, zero-sequence, and ground restraint currents.

- Harmonic metering up to the 21st harmonic, total harmonic distortion (THD), as well as harmonic derating factor.
 - Phase-to-neutral voltage metering, volts-per-hertz, and system frequency.
 - Tap changer position.
 - Current demand for each winding including peak values.
 - Real, reactive, and apparent power for each winding, along with the power factor.
 - Energy metering (Wh and varh) for each winding
 - Transformer loss-of-life and ambient temperature metering
 - Analog inputs.
3. Event recorder downloading tool.
 4. Product information including model number, firmware version, additional product information, and calibration dates.
 5. Oscillography and data logger downloading tool.
 - ▷ Select an actual values window to also open the **actual values** tree from the corresponding device in the site list and highlight the current location in the hierarchy.

For complete details on actual values, refer to Chapter 6.

To view a separate window for each group of actual values,

- ▷ Select the desired item from the tree.
- ▷ Double click with the left mouse button.
Each group will be opened on a separate tab. The windows can be re-arranged to maximize data viewing as shown in the following figure (showing actual demand, harmonic contents, and current values tiled in the same window):

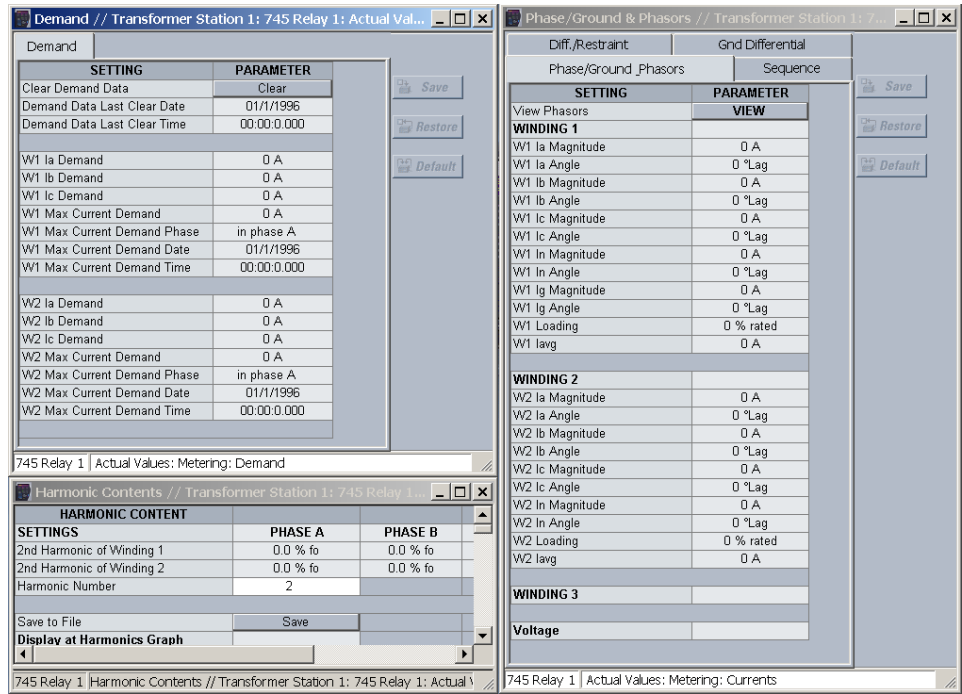

Figure 4-4: Actual values display

4.7 Using EnerVista Viewpoint with the 745

4.7.1 Plug and Play Example

EnerVista Viewpoint is an optional software package that puts critical 745 information onto any PC with plug-and-play simplicity. EnerVista Viewpoint connects instantly to the 745 via serial, ethernet or modem and automatically generates detailed overview, metering, power, demand, energy and analysis screens. Installing EnerVista Launchpad (see previous section) allows the user to install a fifteen-day trial version of EnerVista Viewpoint. After the fifteen day trial period you will need to purchase a license to continue using EnerVista Viewpoint. Information on license pricing can be found at <http://www.enervista.com>.

- ▷ Install the EnerVista Viewpoint software from the GE EnerVista CD.
- ▷ Ensure that the 745 device has been properly configured for either serial or Ethernet communications (see previous sections for details).
- ▷ Click the **Viewpoint** window in EnerVista to log into EnerVista Viewpoint. At this point, you will be required to provide a login and password if you have not already done so.



Figure 4-5: EnerVista Viewpoint main window

- ▷ Click the **Device Setup** button to open the Device Setup window.
- ▷ Click the **Add Site** button to define a new site.
- ▷ Enter the desired site name in the **Site Name** field.
If desired, a short description of site can also be entered along with the display order of devices defined for the site.
- ▷ Click the **OK** button when complete.
The new site will appear in the upper-left list in the EnerVista 745 Setup window.
- ▷ Click the **Add Device** button to define the new device.
- ▷ Enter the desired name in the **Device Name** field and a description (optional) of the site.

- ▶ Select the appropriate communications interface (Ethernet or Serial) and fill in the required information for the 745. See *EnerVista Software Interface* on page 4–8 for details.

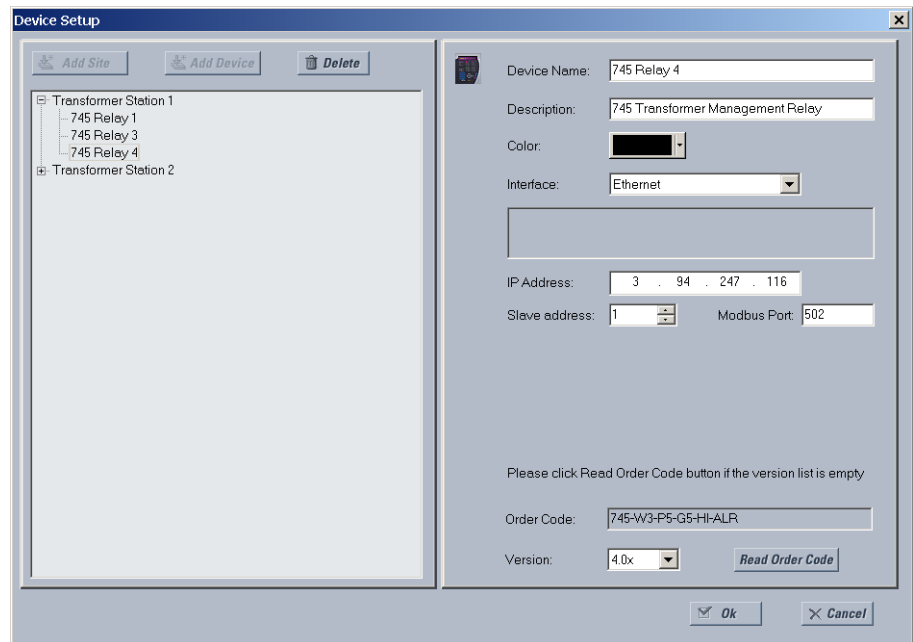

Figure 4-6: Device setup screen (example)

- ▶ Click the **Read Order Code** button to connect to the 745 device and upload the order code.
If a communications error occurs, ensure that communications values entered in the previous step correspond to the relay setting values.
- ▶ Click **OK** when complete.
- ▶ From the EnerVista main window, select the **IED Dashboard** item to open the Plug and Play IED dashboard. An icon for the 745 will be shown.

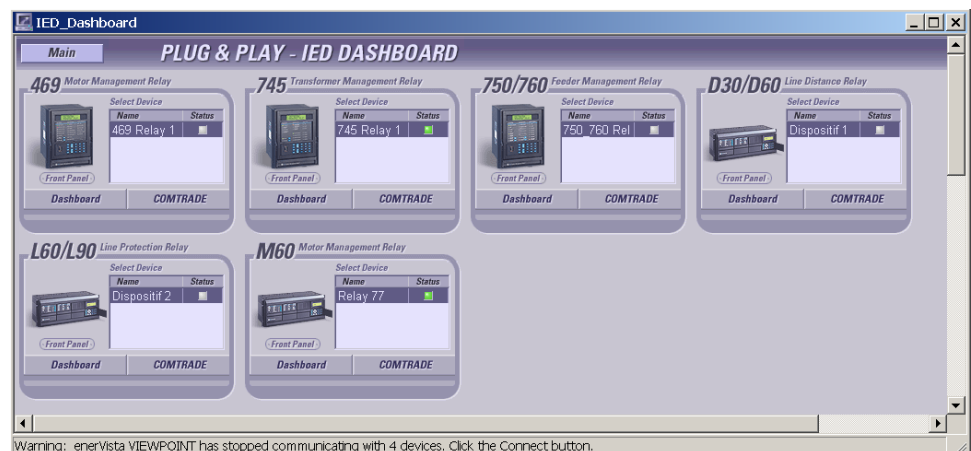

FIGURE 4–7: 'Plug and play' dashboard

- Click the **Dashboard** button below the 745 icon to view the device information. We have now successfully accessed our 745 through EnerVista Viewpoint.

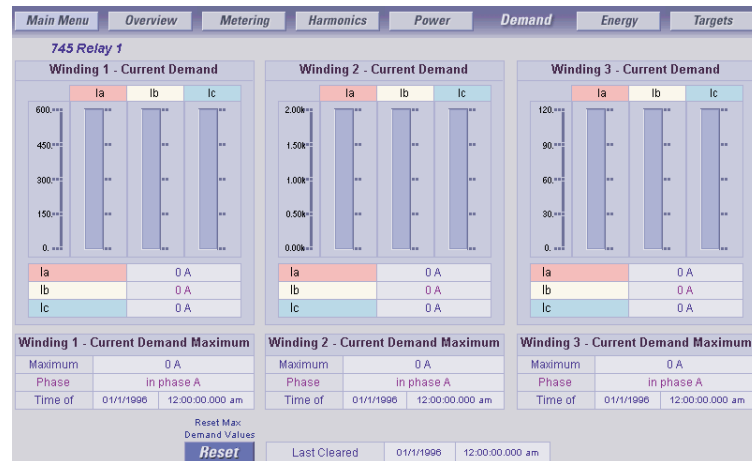
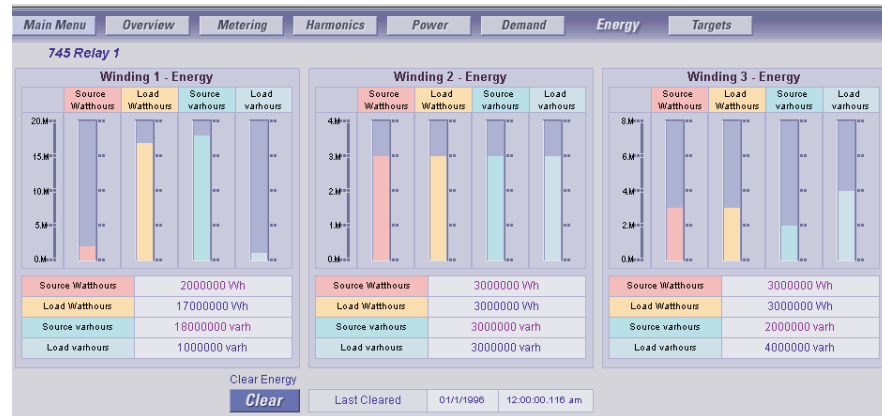
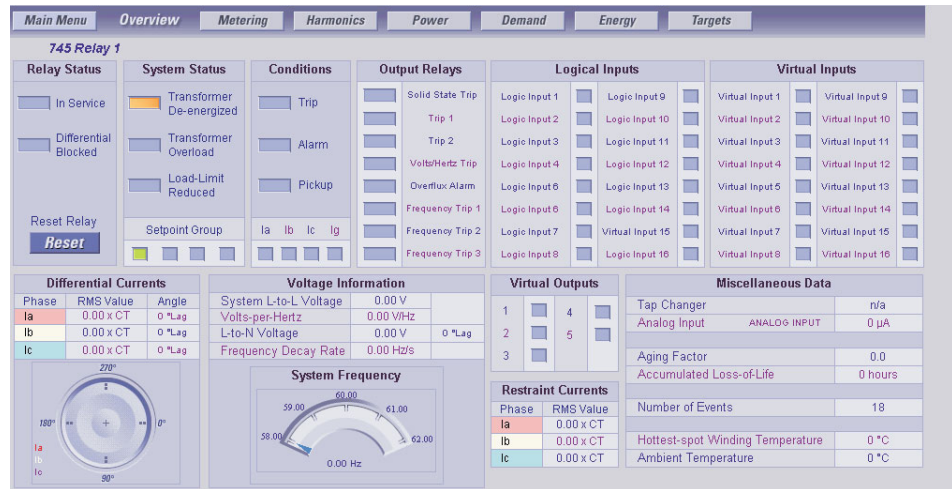

FIGURE 4–8: EnerVista plug and play screens (example)

For additional information on EnerVista viewpoint, please visit the EnerVista website at <http://www.enervista.com>.



745 Transformer Protection System













































Chapter 5: Setpoints























5.1 Overview

5.1.1 Setpoint Message Map

The 745 relay has a considerable number of programmable settings (setpoints) that makes it extremely flexible. The setpoints have been grouped into a number of pages as shown below. If using the EnerVista 745 Setup software and not connected to a relay, you may have to select the **File > Properties** menu item and set the correct options for your relay.

■ SETPOINTS S1 745 SETUP	◀ ▶	■ PASSCODE	▶	See page 5-25
MESSAGE	◀ ▶	■ PREFERENCES	▶	See page 5-25
MESSAGE	◀ ▶	■ COMMUNICATIONS	▶	See page 5-26
MESSAGE	◀ ▶	■ RESETTING	▶	See page 5-29
MESSAGE	◀ ▶	■ CLOCK	▶	See page 5-29
MESSAGE	◀ ▶	■ DEFAULT MESSAGES	▶	See page 5-30
MESSAGE	◀ ▶	■ SCRATCHPAD	▶	See page 5-31
MESSAGE	◀ ▶	■ INSTALLATION	▶	See page 5-31
MESSAGE	◀ ▶	■ UPGRADE OPTIONS	▶	See page 5-31
MESSAGE	◀ ▶	■ SETUP EVENT RECORDER	▶	See page 5-33

	MESSAGE		■ END OF PAGE S1	
			■ SETPOINTS S2 SYSTEM SETUP 	
			■ TRANSFORMER 	See page 5-34
	MESSAGE		■ WINDING 1 	See page 5-36
	MESSAGE		■ WINDING 2 	See page 5-36
	MESSAGE		■ WINDING 3 	See page 5-36
	MESSAGE		■ ONLOAD TAP CHANGER 	See page 5-37
	MESSAGE		■ HARMONICS 	See page 5-38
	MESSAGE		■ FLEXCURVES 	See page 5-38
	MESSAGE		■ VOLTAGE INPUT 	See page 5-39
	MESSAGE		■ AMBIENT TEMP 	See page 5-39
	MESSAGE		■ ANALOG INPUT 	See page 5-41
	MESSAGE		■ DEMAND METERING 	See page 5-41
	MESSAGE		■ ANALOG OUTPUTS 	See page 5-43
	MESSAGE		■ END OF PAGE S2	
			■ SETPOINTS S3 LOGIC INPUTS 	
			■ LOGIC INPUTS 	See page 5-44
	MESSAGE		■ VIRTUAL INPUTS 	See page 5-45
	MESSAGE		■ END OF PAGE S3	
			■ SETPOINTS S4 ELEMENTS 	
			■ SETPOINT GROUP 	See page 5-47
	MESSAGE		■ DIFFERENTIAL 	See page 5-48
	MESSAGE		■ INST DIFFERENTIAL 	See page 5-57
	MESSAGE		■ PHASE OC 	See page 5-58

	MESSAGE		■ NEUTRAL OC ▷		See page 5-66	
	MESSAGE		■ GROUND OC ▷		See page 5-69	
	MESSAGE		■ RESTRICTED GROUND ▷		See page 5-72	
	MESSAGE		■ NEG SEQ OC ▷		See page 5-76	
	MESSAGE		■ FREQUENCY ▷		See page 5-78	
	MESSAGE		■ OVEREXCITATION ▷		See page 5-83	
	MESSAGE		■ HARMONICS ▷		See page 5-88	
	MESSAGE		■ INSULATION AGING ▷		See page 5-90	
	MESSAGE		■ ANALOG INPUT ▷		See page 5-94	
	MESSAGE		■ CURRENT DEMAND ▷		See page 5-95	
	MESSAGE		■ XFORMER OVERLOAD ▷		See page 5-96	
	MESSAGE		■ TAP CHANGER FAILURE ▷		See page 5-97	
	MESSAGE		■ END OF PAGE S4			
						
			■ SETPOINTS S5 OUTPUTS ▷			
					■ OUTPUT RELAYS ▷	See page 5-102
	MESSAGE				■ TRACE MEMORY ▷	See page 5-105
	MESSAGE				■ VIRTUAL OUTPUTS ▷	See page 5-106
	MESSAGE				■ TIMERS ▷	See page 5-106
	MESSAGE				■ END OF PAGE S5	
						
			■ SETPOINTS S6 TESTING ▷			
					■ OUTPUT RELAYS ▷	See page 5-107
	MESSAGE				■ ANALOG OUTPUTS ▷	See page 5-108
	MESSAGE				■ SIMULATION ▷	See page 5-108

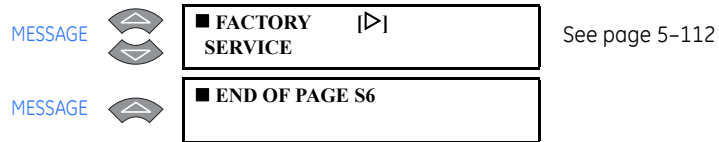

5.1.2 Setpoint entry

Prior to commissioning the 745 relay, setpoints defining transformer characteristics, inputs, output relays, and protection settings must be entered, via one of the following methods:

- Front panel, using the keypad and display.
- Front panel RS232, rear terminal RS485/RS422, or Ethernet communication ports, and a portable computer running the EnerVista 745 Setup software or a SCADA system running user-written software.

Any of these methods can be used to enter the same information. A computer, however, makes entry much easier. Files can be stored and downloaded for fast, error free entry when a computer is used. Settings files can be prepared and stored on disk without the need to connect to a relay.

All setpoint messages are illustrated and described in blocks throughout this chapter. *The 745 relay leaves the factory with setpoints programmed to default values, and it is these values that are shown in all the setpoint message illustrations.* Some of these factory default values can be left unchanged.

There are many 745 setpoints that must be entered for the relay to function correctly. In order to safeguard against installation when these setpoints have not been entered, the 745 does not allow signaling of any output relay. In addition, the In Service LED is off and the Self-Test Error LED on until the [S1 745 SETUP ▾ ▽ INSTALLATION ▸ ▹ 745 SETPOINTS](#) value is set to “Programmed”. This setpoint is defaulted to “Not Programmed” when the relay leaves the factory. The [SETPOINTS HAVE NOT BEEN PROGRAMMED](#) diagnostic message appears until the 745 is put in the programmed state:

Messages may vary somewhat from those illustrated because of installed options. Also, some messages associated with disabled features (or optional features which have not been ordered) are hidden. *These messages are shown with a shaded message box.*

- **Keypad entry:** See *Using the Relay* on page 1–3 for details on maneuvering through the messages, viewing actual values, and changing setpoints.
- **Computer entry:** Setpoint values are grouped together on a screen in the EnerVista 745 Setup software. The data is organized in a system of menus. See *EnerVista Software Interface* on page 4–8 for details.
- **SCADA entry:** Details of the complete communication protocol for reading and writing setpoints are given in chapters 8 and 9. A programmable SCADA system connected to the RS485/RS422 terminals can make use of communication commands for remote setpoint programming, monitoring, and control.

5.1.3 Setpoint Write Access

The 745 design incorporates hardware and passcode security features to provide protection against unauthorized setpoint changes.

A hardware jumper must be installed across the setpoint access terminals on the back of the relay to program new setpoints using the front panel keys. When setpoint programming is via a computer connected to the communication ports, no setpoint access jumper is required.

Passcode protection may also be enabled. When enabled, the 745 requests a numeric passcode before any setpoint can be entered. As an additional safety measure, a minor self-test error is generated when the passcode is entered incorrectly three times in a row.

5.2 Auto-configuration

5.2.1 Introduction

For transformer differential protection, it is necessary to correct the magnitude and phase relationships of the CT secondary currents for each winding, in order to obtain near zero differential currents under normal operating conditions. Traditionally, this has been accomplished using interposing CTs or tapped relay windings and compensating CT connections at the transformer.

The 745 simplifies CT configuration issues by having all CTs connected Wye (polarity markings pointing away from the transformer). All phase angle and magnitude corrections, as well as zero-sequence current compensation, are performed automatically based upon user entered setpoints.

This section describes the process of auto-configuration by means of a specific example, showing how CT ratios, transformer voltage ratios, and the transformer phase shifts are used to generate correction factors. These correction factors are applied to the current signals to obtain extremely accurate differential currents.

Consider a typical wye-delta power transformer with the following data:

- Connection: Y/d30° (i.e. delta winding phases lag corresponding wye winding phases by 30°)
- Winding 1: 100/133/166 MVA, 220 kV nominal, 500/1 CT ratio
- Winding 2: 100/133/166 MVA, 69 kV nominal, 1500/1 CT ratio
onload tap changer: 61 to 77 kV in 0.5 kV steps (33 tap positions)
- Auxiliary cooling: two stages of forced air

The following sections will illustrate auto-configuration principles using this example.

5.2.2 Dynamic CT Ratio Mismatch Correction

5.2.2.1 Use of Standard CT Ratios

- Standard CT ratios: $CT_2 / CT_1 = V_1 / V_2$
- Tapped relay windings / interposing CTs (inaccurate/expensive)

Solution:

- Wx Nom Voltage, Wx rated Load, Wx CT primary setpoints
- Automatic correction for mismatch: $(CT_2 \times V_2) / (CT_1 \times V_1) < 16$

Even ignoring the onload tap changer, the 1500/1 CT on winding 2 does not perfectly match the 500/1 CT on winding 1. A perfectly matched winding 2 CT ratio (at nominal winding 2 voltage) is calculated as follows:

$$CT_2 \text{ (ideal)} = CT_1 \times \frac{V_1}{V_2} = \frac{500}{1} \times \frac{220 \text{ kV}}{69 \text{ kV}} = \frac{1594.2}{1} \tag{EQ 5.1}$$

where CT_1 = winding 1 CT ratio
 V_1 = winding 1 nominal voltage
 CT_2 = winding 2 CT ratio
 V_2 = winding 2 nominal voltage

Thus, for any load, the winding 2 CT secondary current is higher (per unit) than the winding 1 CT secondary current. The mismatch factor is $1594.2 / 1500 = 1.063$.

The transformer type is entered as **S2 SYSTEM SETUP ▷ TRANSFORMER ▷ TRANSFORMER TYPE**. The 745 calculates and automatically corrects for CT mismatch to a maximum mismatch factor of 16. The following information is entered as setpoints:

S2 SYSTEM SETUP ▷ WINDING 1 ▷ WINDING 1 NOM F-F VOLTAGE: "220 kV"
S2 SYSTEM SETUP ▷ WINDING 1 ▷ WINDING 1 RATED LOAD: "100 MVA"
S2 SYSTEM SETUP ▷ WINDING 1 ▷ WINDING 1 PHASE CT PRIMARY: "500:1 A"
S2 SYSTEM SETUP ▷ WINDING 2 ▷ WINDING 2 NOM F-F VOLTAGE: "69.0 kV"
S2 SYSTEM SETUP ▷ WINDING 2 ▷ WINDING 2 RATED LOAD: "100 MVA"
S2 SYSTEM SETUP ▷ WINDING 2 ▷ WINDING 2 PHASE CT PRIMARY: "1500:1 A"

For a three-winding transformer, the setpoints under the **S2 SYSTEM SETUP ▷ WINDING 3** menu must also be set.

5.2.2.2 Onload Tap Changer

- Onload tap changer
- Variable voltage ratio
- $CT_2 / CT_1 = V_1 / V_2$
- Lower sensitivity on differential element

Solution:

- Tap position monitoring: $V_2 = V_{min} + (n - 1)V_{incr}$

For example, the onload tap changer changes the winding 2 voltage, resulting in an even greater CT mismatch. A perfectly matched winding 2 CT ratio (based on the tap changer position) is calculated as follows:

$$CT_2 \text{ (ideal)} = CT_1 \times \frac{V_1}{V_{2(\min)} + V_{2(\text{tap})}(n - 1)} = \frac{500}{1} \times \frac{220}{61 + 0.5(n - 1)} \quad (\text{EQ 5.2})$$

where n = current tap changer position
 $V_{2(\min)}$ = winding 2 minimum voltage (at $n = 1$)
 $V_{2(\text{tap})}$ = winding 2 voltage increment per tap

Thus, with the tap changer at position 33, the Winding 2 CT ratio must be $1428.6 / 1$ to be perfectly matched. In this case, the mismatch factor is $1428.6 / 1500 = 0.952$.

The 745 allows monitoring of the tap changer position via the tap position input. With this input, the 745 dynamically adjusts the CT ratio mismatch factor based on the actual transformer voltage ratio set by the tap changer.

Tap changers are operated by means of a motor drive unit mounted on the outside of the transformer tank. The motor drive is placed in a protective housing containing all devices necessary for operation, including a tap position indication circuit. This indication circuit has a terminal for each tap with a fixed resistive increment per tap. A cam from the drive shaft that provides local tap position indication also controls a wiper terminal in the indication circuit, as illustrated below.

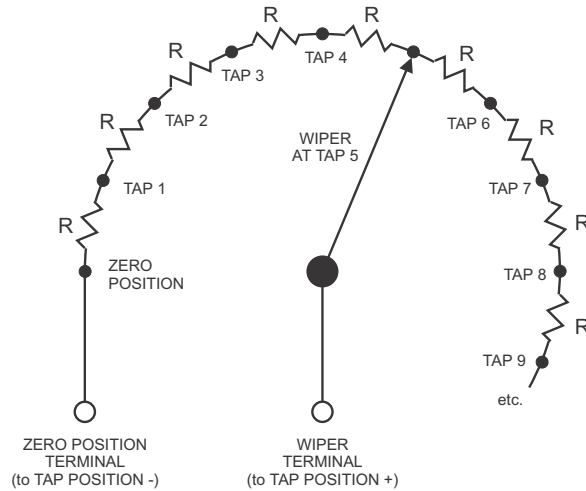

FIGURE 5-1: Tap position input

The “zero position” terminal and the “wiper” terminal of the tap position circuit are connected to the positive and negative 745 tap position terminals. Polarity is not consequential. The following setpoints configure the 745 to determine tap position. In the [S2 SYSTEM SETUP > ONLOAD TAP CHANGER](#) setpoint menu, make the following settings:

- WINIDNG WITH TAP CHANGER:** “Winding 2”
- NUMBER OF TAP POSITIONS:** “33”
- MINIMUM TAP POSITION VOLTAGE:** “61.0 kV”
- VOLTAGE INCREMENT PER TAP:** “0.50 kV”
- RESISTANCE INCREMENT PER TAP:** “33 Ω”

The maximum value resistance on the top tap is 5 kΩ.

5.2.3 Phase Shifts on Three-phase Transformers

Power transformers that are built in accordance with ANSI and IEC standards are required to identify winding terminals and phase relationships among the windings of the transformer.

ANSI standard C.37.12.70 requires that the labels of the terminals include the characters 1, 2, and 3 to represent the names of the individual phases. The phase relationship among the windings must be shown as a phasor diagram on the nameplate, with the winding terminals clearly labeled. This standard specifically states that the phase relationships are established for a condition where the source phase sequence of 1-2-3 is connected to transformer windings labeled 1, 2 and 3 respectively.

IEC standard 60076-1 (1993) states that the terminal markings of the three phases follow national practice. The phase relationship among the windings is shown as a specified notation on the nameplate, and there may be a phasor diagram. In this standard the arbitrary labeling of the windings is shown as I, II, and III. This standard specifically states that the phase relationships are established for a condition where a source phase sequence of I - II - III is connected to transformer windings labeled I, II and III respectively.

The source phase sequence must be stated when describing the winding phase relationships since these relationships change when the phase sequence changes. The example below shows why this happens, using a transformer described in IEC nomenclature as “Yd1” or in GE Multilin nomenclature as “Y/d30.”

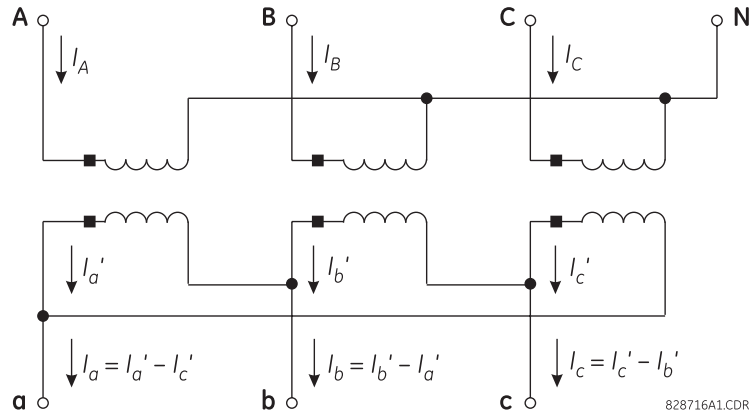

FIGURE 5-2: Example transformer

The above figure shows the physical connections within the transformer that produce a phase angle in the delta winding that lags the respective wye winding by 30°. The winding currents are also identified. Note that the total current out of the delta winding is described by an equation. Now assume that a source, with a sequence of ABC, is connected to transformer terminals ABC, respectively. The currents that would be present for a balanced load are shown below.

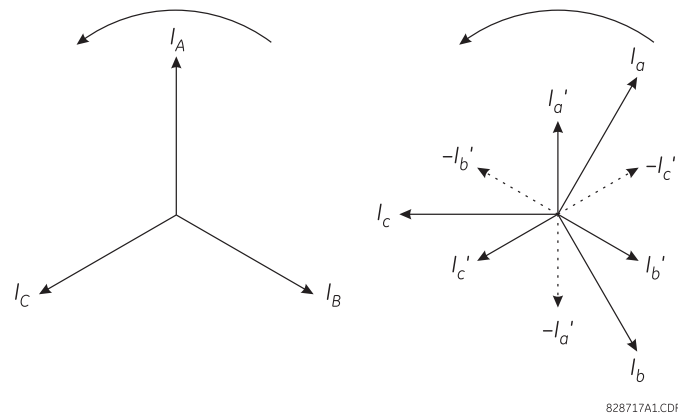

FIGURE 5-3: Phasors for ABC sequence

Note that the delta winding currents lag the wye winding currents by 30°, which is in agreement with the transformer nameplate.

Now assume that a source, with a sequence of ACB is connected to transformer terminals A, C, B respectively. The currents that would be present for a balanced load are shown below:

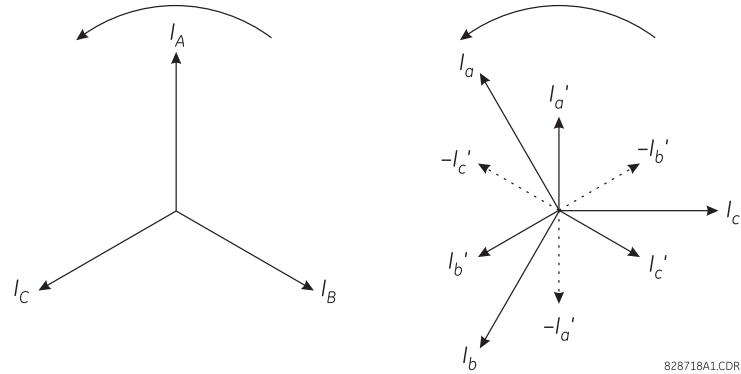

FIGURE 5-4: Phasors for ACB sequence

Note that the delta winding currents leads the wye winding currents by 30°, (which is a type Yd11 in IEC nomenclature and a type Y/d330 in GE Multilin nomenclature) which is in disagreement with the transformer nameplate. This is because the physical connections and hence the equations used to calculate current for the delta winding have not changed. The transformer nameplate phase relationship information is only correct for a stated phase sequence.

It may be suggested that for the ACB sequence the phase relationship can be returned to that shown on the transformer nameplate by connecting source phases A, B and C to transformer terminals A, C, and B respectively. This will restore the nameplate phase shifts but will cause incorrect identification of phases B and C within the relay, and is therefore not recommended.

All information presented in this manual is based on connecting the relay phase A, B and C terminals to the power system phases A, B and C respectively. The transformer types and phase relationships presented are for a system phase sequence of ABC, in accordance with the standards for power transformers. Users with a system phase sequence of ACB must determine the transformer type for this sequence.

5.2.4 Phase Angle Correction

The following diagram shows the internal connections of the Y/d30° transformer of our example:

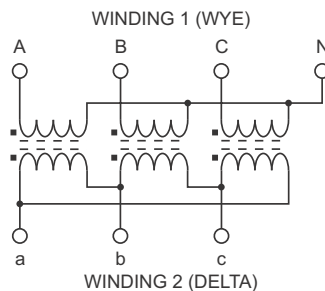

FIGURE 5-5: Wye/delta (30° lag) transformer

Under balanced conditions, the winding 2 phase current phasors lag the corresponding phase current phasors of winding 1 by 30°. With CTs connected in a wye arrangement (polarity markings pointing away from the transformer), the corresponding phase currents cannot be summed directly to obtain a zero differential current, since corresponding phasors will NOT be 180° out-of-phase.

Traditionally, this problem is solved by connecting the CTs on the wye side of the transformer (winding 1) in a delta arrangement. This compensates for the phase angle lag introduced in the delta side (winding 2).

The 745 performs this phase angle correction internally based on the following setpoint. Set **S2 SYSTEM SETUP > TRANSFORMER > TRANSFORMER TYPE** to “Y/d30°”.

The 745 supports over 100 two and three-winding transformer types. Table 5-1: *Transformer types* on page 5-13 provides the following information about each transformer type:

Transformer type	Wdg.	Connection	Voltage phasors	Phase shift
Y/d30°	1	WYE (gnd 1/2)		30° lag
	2	DELTA 30° Lag		0°

814721A1.CDR

As shown in the “Y/d30°” entry of the transformer types table, the phase angle correction (or phase shift) introduces 30° lag in winding 1. This lag is described in *Phase shifts* on page 5-24. This table provides the following information about each phase shift type:

Phase shift	Input phasors	Output phasors	Phasor transformation
30° lag			$a = (A - C) / \sqrt{3}$ $b = (B - C) / \sqrt{3}$ $c = (C - B) / \sqrt{3}$

814720A1.CDR

5.2.5 Zero-sequence Component Removal

1. If zero-sequence current can flow into and out of one transformer winding (e.g. a grounded wye or zig-zag winding) but not the other winding (e.g. a delta winding), external ground faults will cause the differential element to operate incorrectly. Traditionally, this problem is solved by delta connecting the CTs on the wye side of a wye/delta transformer so that the currents coming to the relay are both phase

corrected and void of zero-sequence current. Because the 745 software mimics the CT delta connection, the zero-sequence current is automatically removed from all Wye or zig-zag winding currents of transformers having at least one delta winding.

2. External ground faults also cause maloperation of the differential element for transformers having an in-zone grounding bank on the delta side (and the wye connected CTs on the same side). Traditionally, this problem is solved by inserting a zero-sequence current trap in the CT circuitry. The 745 automatically removes zero-sequence current from all delta winding currents when calculating differential current. Where there is no source of zero-sequence current (e.g. delta windings not having a grounding bank), the 745 effectively removes nothing.
3. Autotransformers have an internal tertiary winding to provide a path for third-harmonic currents and control transient overvoltages. Also, many two-winding wye/wye transformers have a three-legged core construction that forces zero-sequence flux into the transformer tank, creating an inherent delta circuit. In both these cases, there is zero-sequence impedance between the primary and secondary windings. The 745 removes zero-sequence current from all wye/wye and wye/wye/wye transformer windings to prevent possible relay maloperations resulting from these two conditions.

5.2.6 Transformer Types

A complete table of transformer types is shown below.

Table 5-1: Transformer types (Sheet 1 of 11)





























Transformer type	Wdg.	Connection	Voltage phasors	Phase shift	Transformer type	Wdg.	Connection	Voltage phasors	Phase shift
2W External Correction	1	WYE (gnd 1/2)		0°	Y/y0°	1	WYE (gnd 1/2)		0°
	2	WYE (gnd 2/3) 0°		0°		2	WYE (gnd 2/3) 0°		0°
Y/y180°	1	WYE (gnd 1/2)		180° lag	Y/d30°	1	WYE (gnd 1/2)		30° lag
	2	WYE (gnd 2/3) 180° lag		0°		2	DELTA (gnd 2/3) 30° lag		0°
Y/d150°	1	WYE (gnd 1/2)		150° lag	Y/d210°	1	WYE (gnd 1/2)		210° lag
	2	DELTA (gnd 2/3) 150° lag		0°		2	DELTA (gnd 2/3) 210° lag		0°
Y/d330°	1	WYE (gnd 1/2)		330° lag	D/d0°	1	DELTA (gnd 1/2)		0°
	2	DELTA (gnd 2/3) 330° lag		0°		2	DELTA (gnd 2/3) 0°		0°
D/d60°	1	DELTA (gnd 1/2)		60° lag	D/d120°	1	DELTA (gnd 1/2)		120° lag
	2	DELTA (gnd 2/3) 60° lag		0°		2	DELTA (gnd 2/3) 120° lag		0°
D/d180°	1	DELTA (gnd 1/2)		180° lag	D/d240°	1	DELTA (gnd 1/2)		240° lag
	2	DELTA (gnd 2/3) 180° lag		0°		2	DELTA (gnd 2/3) 240° lag		0°
D/d300°	1	DELTA (gnd 1/2)		300° lag	D/y30°	1	DELTA (gnd 1/2)		0°
	2	DELTA (gnd 2/3) 300° lag		0°		2	WYE (gnd 2/3) 30° lag		330° lag

Table 5-1: Transformer types (Sheet 2 of 11)





























Transformer type	Wdg.	Connection	Voltage phasors	Phase shift	Transformer type	Wdg.	Connection	Voltage phasors	Phase shift
D/y150°	1	DELTA (gnd 1/2)		0°	D/y210°	1	DELTA (gnd 1/2)		0°
	2	WYE (gnd 2/3) 150° lag		210° lag		2	WYE (gnd 2/3) 210° lag		150° lag
D/y330°	1	DELTA (gnd 1/2)		0°	Y/z30°	1	WYE (gnd 1/2)		30° lag
	2	WYE (gnd 2/3) 330° lag		30° lag		2	ZIG-ZAG (gnd 2/3) 30° lag		0°
Y/z150°	1	WYE (gnd 1/2)		150° lag	Y/z210°	1	WYE (gnd 1/2)		210° lag
	2	ZIG-ZAG (gnd 2/3) 150° lag		0°		2	ZIG-ZAG (gnd 2/3) 210° lag		0°
Y/z330°	1	WYE (gnd 1/2)		330° lag	D/z0°	1	DELTA (gnd 1/2)		0°
	2	ZIG-ZAG (gnd 2/3) 330° lag		0°		2	ZIG-ZAG (gnd 2/3) 0° lag		0°
D/z60°	1	DELTA (gnd 1/2)		60° lag	D/z120°	1	DELTA (gnd 1/2)		120° lag
	2	ZIG-ZAG (gnd 2/3) 60° lag		0°		2	ZIG-ZAG (gnd 2/3) 120° lag		0°
D/z180°	1	DELTA (gnd 1/2)		180° lag	D/z240°	1	DELTA (gnd 1/2)		240° lag
	2	ZIG-ZAG (gnd 2/3) 180° lag		0°		2	ZIG-ZAG (gnd 2/3) 240° lag		0°
D/z300°	1	DELTA (gnd 1/2)		300° lag	3W External Correction	1	WYE		0°
	2	ZIG-ZAG (gnd 2/3) 300° lag		0°		2	WYE 0°		0°
						3	WYE 0°		0°

Table 5-1: Transformer types (Sheet 3 of 11)

Transformer type	Wdg.	Connection	Voltage phasors	Phase shift	Transformer type	Wdg.	Connection	Voltage phasors	Phase shift
Y/y0°/d30°	1	WYE		30° lag	Y/y0°/d150°	1	WYE		150° lag
	2	WYE 0°		30° lag		2	WYE 0°		150° lag
	3	DELTA 30° lag		0°		3	DELTA 150° lag		0°
Y/y0°/d210°	1	WYE		210° lag	Y/y0°/d330°	1	WYE		330° lag
	2	WYE 0°		210° lag		2	WYE 0°		330° lag
	3	DELTA 210° lag		0°		3	DELTA 330° lag		0°
Y/y180°/d30°	1	WYE		30° lag	Y/y180°/d150°	1	WYE		150° lag
	2	WYE 180° lag		210° lag		2	WYE 180° lag		330° lag
	3	DELTA 30° lag		0°		3	DELTA 150° lag		0°
Y/y180°/d210°	1	WYE		210° lag	Y/y180°/d330°	1	WYE		330° lag
	2	WYE 180° lag		30° lag		2	WYE 180° lag		150° lag
	3	DELTA 210° lag		0°		3	DELTA 330° lag		0°
Y/d30°/y0°	1	WYE		30° lag	Y/d30°/y180°	1	WYE		30° lag
	2	DELTA 30° lag		0°		2	DELTA 30° lag		0°
	3	WYE 0°		30° lag		3	WYE 180° lag		210° lag

Table 5-1: Transformer types (Sheet 4 of 11)































Transformer type	Wdg.	Connection	Voltage phasors	Phase shift	Transformer type	Wdg.	Connection	Voltage phasors	Phase shift
Y/d30°/d30°	1	WYE		30° lag	Y/d30°/d150°	1	WYE		30° lag
	2	DELTA 30° lag		0°		2	DELTA 30° lag		0°
	3	DELTA 30° lag		0°		3	DELTA 150° lag		240° lag
Y/d30°/d210°	1	WYE		30° lag	Y/d30°/d330°	1	WYE		30° lag
	2	DELTA 30° lag		0°		2	DELTA 30° lag		0°
	3	DELTA 210° lag		180° lag		3	DELTA 330° lag		60° lag
Y/d150°/y0°	1	WYE		150° lag	Y/d150°/y180°	1	WYE		150° lag
	2	DELTA 150° lag		0°		2	DELTA 150° lag		0°
	3	WYE 0°		150° lag		3	WYE 180° lag		330° lag
Y/d150°/d30°	1	WYE		150° lag	Y/d150°/d150°	1	WYE		150° lag
	2	DELTA 150° lag		0°		2	DELTA 150° lag		0°
	3	DELTA 30° lag		120° lag		3	DELTA 150° lag		0°
Y/d150°/d210°	1	WYE		150° lag	Y/d150°/d330°	1	WYE		150° lag
	2	DELTA 150° lag		0°		2	DELTA 150° lag		0°
	3	DELTA 210° lag		300° lag		3	DELTA 330° lag		180° lag

Table 5-1: Transformer types (Sheet 5 of 11)































Transformer type	Wdg.	Connection	Voltage phasors	Phase shift	Transformer type	Wdg.	Connection	Voltage phasors	Phase shift
Y/d210°/y0°	1	WYE		210° lag	Y/d210°/y180°	1	WYE		210° lag
	2	DELTA 210° lag		0°		2	DELTA 210° lag		0°
	3	WYE 0°		210° lag		3	WYE 180° lag		30° lag
Y/d210°/d30°	1	WYE		210° lag	Y/d210°/d150°	1	WYE		210° lag
	2	DELTA 210° lag		0°		2	DELTA 210° lag		0°
	3	DELTA 30° lag		180° lag		3	DELTA 150° lag		60° lag
Y/d210°/d210°	1	WYE		210° lag	Y/d210°/d330°	1	WYE		210° lag
	2	DELTA 210° lag		0°		2	DELTA 210° lag		0°
	3	DELTA 210° lag		0°		3	DELTA 330° lag		240° lag
Y/d330°/y0°	1	WYE		330° lag	Y/d330°/y180°	1	WYE		330° lag
	2	DELTA 330° lag		0°		2	DELTA 330° lag		0°
	3	WYE 0°		330° lag		3	WYE 180° lag		150° lag
Y/d330°/d30°	1	WYE		330° lag	Y/d330°/d150°	1	WYE		330° lag
	2	DELTA 330° lag		0°		2	DELTA 330° lag		0°
	3	DELTA 30° lag		300° lag		3	DELTA 150° lag		180° lag

Table 5-1: Transformer types (Sheet 6 of 11)

Transformer type	Wdg.	Connection	Voltage phasors	Phase shift	Transformer type	Wdg.	Connection	Voltage phasors	Phase shift
Y/d330°/d210°	1	WYE		330° lag	Y/d330°/d330°	1	WYE		330° lag
	2	DELTA 330° lag		0°		2	DELTA 330° lag		0°
	3	DELTA 210° lag		120° lag		3	DELTA 330° lag		0°
D/d0°/d0°	1	DELTA		0°	D/d0°/d60°	1	DELTA		60° lag
	2	DELTA 0°		0°		2	DELTA 0°		60° lag
	3	DELTA 0°		0°		3	DELTA 60° lag		0°
D/d0°/d120°	1	DELTA		120° lag	D/d0°/d180°	1	DELTA		180° lag
	2	DELTA 0°		120° lag		2	DELTA 0°		180° lag
	3	DELTA 120° lag		0°		3	DELTA 180° lag		0°
D/d0°/d240°	1	DELTA		240° lag	D/d0°/d300°	1	DELTA		300° lag
	2	DELTA 0°		240° lag		2	DELTA 0°		300° lag
	3	DELTA 240° lag		0°		3	DELTA 300° lag		0°
D/d0°/y30°	1	DELTA		0°	D/d0°/y150°	1	DELTA		0°
	2	DELTA 0°		0°		2	DELTA 0°		0°
	3	WYE 30° lag		330° lag		3	WYE 150° lag		210° lag

Table 5-1: Transformer types (Sheet 7 of 11)































Transformer type	Wdg.	Connection	Voltage phasors	Phase shift	Transformer type	Wdg.	Connection	Voltage phasors	Phase shift
D/d0°/y210°	1	DELTA		0°	D/d0°/y330°	1	DELTA		0°
	2	DELTA 0°		0°		2	DELTA 0°		0°
	3	WYE 210° lag		150° lag		3	WYE 330° lag		30° lag
D/d60°/d0°	1	DELTA		60° lag	D/d60°/d60°	1	DELTA		60° lag
	2	DELTA 60° lag		0°		2	DELTA 60° lag		0°
	3	DELTA 0°		60° lag		3	DELTA 60° lag		0°
D/d60°/d240°	1	DELTA		240° lag	D/d60°/y30°	1	DELTA		0°
	2	DELTA 60° lag		180° lag		2	DELTA 60° lag		300° lag
	3	DELTA 240° lag		0°		3	WYE 30° lag		330° lag
D/d60°/y210°	1	DELTA		0°	D/d120°/d0°	1	DELTA		120° lag
	2	DELTA 60° lag		300° lag		2	DELTA 120° lag		0°
	3	WYE 210° lag		150° lag		3	DELTA 0°		120° lag
D/d120°/d120°	1	DELTA		120° lag	D/d120°/d180°	1	DELTA		120° lag
	2	DELTA 120° lag		0°		2	DELTA 120° lag		0°
	3	DELTA 120° lag		0°		3	DELTA 180° lag		300° lag

Table 5-1: Transformer types (Sheet 8 of 11)































Transformer type	Wdg.	Connection	Voltage phasors	Phase shift	Transformer type	Wdg.	Connection	Voltage phasors	Phase shift
D/d120°/y150°	1	DELTA		0°	D/d120°/y330°	1	DELTA		0°
	2	DELTA 120° lag		240° lag		2	DELTA 120° lag		240° lag
	3	WYE 150° lag		210° lag		3	WYE 330° lag		30° lag
D/d180°/d0°	1	DELTA		180° lag	D/d180°/d120°	1	DELTA		120° lag
	2	DELTA 180° lag		0°		2	DELTA 180° lag		300° lag
	3	DELTA 0°		180° lag		3	DELTA 120° lag		0°
D/d180°/d180°	1	DELTA		0°	D/d180°/d300°	1	DELTA		300° lag
	2	DELTA 180° lag		180° lag		2	DELTA 180° lag		120° lag
	3	DELTA 180° lag		180° lag		3	DELTA 300° lag		0°
D/d180°/y150°	1	DELTA		0°	D/d180°/y330°	1	DELTA		0°
	2	DELTA 180° lag		180° lag		2	DELTA 180° lag		180° lag
	3	WYE 150° lag		210° lag		3	WYE 330° lag		30° lag
D/d240°/d0°	1	DELTA		240° lag	D/d240°/d60°	1	DELTA		240° lag
	2	DELTA 240° lag		0°		2	DELTA 240° lag		0°
	3	DELTA 0°		240° lag		3	DELTA 60° lag		180° lag

Table 5-1: Transformer types (Sheet 9 of 11)































Transformer type	Wdg.	Connection	Voltage phasors	Phase shift	Transformer type	Wdg.	Connection	Voltage phasors	Phase shift
D/d240°/d240°	1	DELTA		240° lag	D/d240°/y30°	1	DELTA		0°
	2	DELTA 240° lag		0°		2	DELTA 240° lag		120° lag
	3	DELTA 240° lag		0°		3	WYE 30° lag		330° lag
D/d240°/y210°	1	DELTA		0°	D/d300°/d0°	1	DELTA		300° lag
	2	DELTA 240° lag		120° lag		2	DELTA 300° lag		0°
	3	WYE 210° lag		150° lag		3	DELTA 0°		300° lag
D/d300°/d180°	1	DELTA		300° lag	D/y30°/d60°	1	DELTA		0°
	2	DELTA 300° lag		0°		2	WYE 30° lag		330° lag
	3	DELTA 180° lag		120° lag		3	DELTA 60° lag		300° lag
D/y30°/d240°	1	DELTA		0°	D/y30°/y30°	1	DELTA		0°
	2	WYE 30° lag		330° lag		2	WYE 30° lag		330° lag
	3	DELTA 240° lag		120° lag		3	WYE 30° lag		330° lag
D/y30°/y210°	1	DELTA		0°	D/y150°/d0°	1	DELTA		0°
	2	WYE 30° lag		330° lag		2	WYE 150° lag		210° lag
	3	WYE 210° lag		150° lag		3	DELTA 0°		0°

Table 5-1: Transformer types (Sheet 10 of 11)































Transformer type	Wdg.	Connection	Voltage phasors	Phase shift	Transformer type	Wdg.	Connection	Voltage phasors	Phase shift
D/y150°/d120°	1	DELTA		0°	D/y150°/d180°	1	DELTA		0°
	2	WYE 150° lag		210° lag		2	WYE 150° lag		210° lag
	3	DELTA 120° lag		240° lag		3	DELTA 180° lag		180° lag
D/y150°/d300°	1	DELTA		0°	D/y150°/y150°	1	DELTA		0°
	2	WYE 150° lag		210° lag		2	WYE 150° lag		210° lag
	3	DELTA 300° lag		60° lag		3	WYE 150° lag		210° lag
D/y150°/y330°	1	DELTA		0°	D/y210°/d0°	1	DELTA		0°
	2	WYE 150° lag		210° lag		2	WYE 210° lag		150° lag
	3	WYE 330° lag		30° lag		3	DELTA 0°		0°
D/y210°/d60°	1	DELTA		0°	D/y210°/d240°	1	DELTA		0°
	2	WYE 210° lag		150° lag		2	WYE 210° lag		150° lag
	3	DELTA 60° lag		300° lag		3	DELTA 240° lag		120° lag
D/y210°/y30°	1	DELTA		0°	D/y210°/y210°	1	DELTA		0°
	2	WYE 210° lag		150° lag		2	WYE 210° lag		150° lag
	3	WYE 30° lag		330° lag		3	WYE 210° lag		150° lag

Table 5-1: Transformer types (Sheet 11 of 11)

Transformer type	Wdg.	Connection	Voltage phasors	Phase shift	Transformer type	Wdg.	Connection	Voltage phasors	Phase shift
D/y330°/d0°	1	DELTA		0°	D/y330°/d120°	1	DELTA		0°
	2	WYE 330° lag		30° lag		2	WYE 330° lag		30° lag
	3	DELTA 0°		0°		3	DELTA 120° lag		240° lag
D/y330°/d180°	1	DELTA		0°	D/y330°/d300°	1	DELTA		0°
	2	WYE 330° lag		30° lag		2	WYE 330° lag		30° lag
	3	DELTA 180° lag		180° lag		3	DELTA 300° lag		60° lag
D/y330°/y150°	1	DELTA		0°	D/y330°/y330°	1	DELTA		0°
	2	WYE 330° lag		30° lag		2	WYE 330° lag		30° lag
	3	WYE 150° lag		210° lag		3	WYE 330° lag		30° lag
Y/z30°/z30°	1	WYE		30° lag	Y/y0°/y0°	1	WYE		0°
	2	ZIG-ZAG 30° lag		0°		2	WYE 0°		0°
	3	ZIG-ZAG 30° lag		0°		3	WYE 0°		0°

5.2.7 Phase Shifts

The table below provides additional information about the **Phase shift** column in Table 5-1: *Transformer types* on page 5-13 and represents an assumed ABC phasor rotation. For transformers connected to a system with a phasor rotation of ACB, interchange all B (b) and C (c) designations.

Table 5-2: Phase shifts

Phase shift	Input phasors	Output phasors	Phasor transformation
0°			$a = A$ $b = B$ $c = C$
30° lag			$a = (A - C) / \sqrt{3}$ $b = (B - A) / \sqrt{3}$ $c = (C - B) / \sqrt{3}$
60° lag			$a = -C$ $b = -A$ $c = -B$
90° lag			$a = (B - C) / \sqrt{3}$ $b = (C - A) / \sqrt{3}$ $c = (A - B) / \sqrt{3}$
120° lag			$a = B$ $b = C$ $c = A$
150° lag			$a = (B - A) / \sqrt{3}$ $b = (C - B) / \sqrt{3}$ $c = (A - C) / \sqrt{3}$
180° lag			$a = -A$ $b = -B$ $c = -C$
210° lag			$a = (C - A) / \sqrt{3}$ $b = (A - B) / \sqrt{3}$ $c = (B - C) / \sqrt{3}$
240° lag			$a = C$ $b = A$ $c = B$
270° lag			$a = (C - B) / \sqrt{3}$ $b = (A - C) / \sqrt{3}$ $c = (B - A) / \sqrt{3}$
300° lag			$a = -B$ $b = -C$ $c = -A$
330° lag			$a = (A - B) / \sqrt{3}$ $b = (B - C) / \sqrt{3}$ $c = (C - A) / \sqrt{3}$

5.3 S1 745 setup

5.3.1 Passcode

PATH: SETPOINTS ▷ S1 745 SETUP ▷ PASSCODE

■ PASSCODE ▷		SETPOINT ACCESS: Read & Write	Range: 1 to 8 numeric digits
MESSAGE		RESTRICT SETPOINT WRITE ACCESS? No	Range: No, Yes
MESSAGE		ALLOW SETPOINT WRITE ACCESS? No	Range: No, Yes
MESSAGE		CHANGE PASSCODE? No	Range: No, Yes
MESSAGE		ENCRYPTED PASSCODE: AIKFBAIK	Range: factory default passcode is "0"

After installing the setpoint access jumper, a passcode must be entered (if the passcode security feature is enabled) before setpoints can be changed. When the 745 is shipped from the factory, the passcode is defaulted to 0. When the passcode is 0, the passcode security feature is disabled and only the setpoint access jumper is required for changing setpoints from the front panel. Passcode entry is also required when programming setpoints from any of the serial communication ports.

- **SETPOINT ACCESS:** This setpoint cannot be edited directly. It indicates if passcode protection is enabled ("Read Only") or disabled ("Read & Write").
- **RESTRICT SETPOINT WRITE ACCESS:** This setpoint is only displayed when setpoint write access is allowed and the current passcode is not "0". Select "Yes" and follow directions to restrict write access. This message is replaced by **ALLOW SETPOINT WRITE ACCESS** when write access is restricted.
- **ALLOW SETPOINT WRITE ACCESS:** This setpoint is displayed when setpoint write access is restricted. New setpoints cannot be entered in this state. To gain write access, select "Yes" and enter the previously programmed passcode. If the passcode is correctly entered, new setpoint entry is allowed. If there is no keypress within 30 minutes, setpoint write access is automatically restricted. As an additional safety measure, the **SELF-TEST ERROR: Access Denied** message is generated when the passcode is entered incorrectly three consecutive times.
- **CHANGE PASSCODE:** Select "Yes" and follow directions to change the current passcode. Changing the passcode to the factory default of "0" disables the passcode security feature.
- **ENCRYPTED PASSCODE:** If the programmed passcode is unknown, consult the factory service department with the encrypted passcode. The passcode can be determined using a deciphering program.

5.3.2 Preferences

PATH: SETPOINTS ▷ S1 745 SETUP ▷ ▾ PREFERENCES

■ PREFERENCES ▷		FLASH MESSAGE TIME: 4.0 s	Range: 0.5 to 10.0 s in steps of 0.5
-------------------------	--	-------------------------------------	--------------------------------------

MESSAGE  **DEFAULT MESSAGE TIMEOUT: 300 s** *Range: 10 to 900 s in steps of 1*









Some relay characteristics can be modified to accommodate the user preferences. This section allows for the definition of such characteristics.

- **FLASH MESSAGE TIME:** Flash messages are status, warning, error, or information messages displayed for several seconds, in response to certain key presses during setpoint programming. The time these messages remain on the display, overriding the normal messages, can be changed to accommodate different user reading rates.
- **DEFAULT MESSAGE TIMEOUT:** After this period of time of no activity on the keys, the 745 automatically begins to display the programmed set of default messages programmed in [S1 745 SETUP ▸ ▾ DEFAULT MESSAGES](#).

5.3.3 Communications

5.3.3.1 Main Menu























PATH: SETPOINTS ▸ S1 745 SETUP ▸ ▾ COMMUNICATIONS

■ COMMUNICATIONS ▷	 	■ PORT SETUP ▷	See below.
MESSAGE 	 	■ DNP ▷	See page 5-27
MESSAGE 	 	■ NETWORK SETUP ▷	See page 5-28

The **NETWORK SETUP** menu is seen only if the Ethernet option is ordered.

5.3.3.2 Port Setup

PATH: SETPOINTS ▸ S1 745 SETUP ▸ ▾ COMMUNICATIONS ▸ PORT SETUP









■ PORT SETUP ▷	 	SLAVE ADDRESS: 254	<i>Range: 1 to 254 in steps of 1</i>
MESSAGE 	 	COM1 BAUD RATE: 19200 Baud	<i>Range: 300, 1200, 2400, 4800, 9600, 19200 Baud</i>
MESSAGE 	 	COM1 PARITY: None	<i>Range: None, Even, Odd</i>
MESSAGE 	 	COM1 HARDWARE: RS485	<i>Range: RS485, RS422</i>
MESSAGE 	 	COM2 BAUD RATE: 19200 Baud	<i>Range: 300, 1200, 2400, 4800, 9600, 19200 Baud</i>
MESSAGE 	 	COM2 PARITY: None	<i>Range: None, Even, Odd</i>
MESSAGE 	 	FRONT BAUD RATE: 19200 Baud	<i>Range: 300, 1200, 2400, 4800, 9600, 19200 Baud</i>
MESSAGE 	 	FRONT PARITY: None	<i>Range: None, Even, Odd</i>

Up to 32 relays can be daisy-chained and connected to a computer or a programmable controller, using either the two-wire RS485 or the four-wire RS422 serial communication port at the rear of the 745. Before using communications, each relay must be programmed with a unique address and a common baud rate.

- **SLAVE ADDRESS:** Enter a unique address, from 1 to 254, for this particular relay on both COM1 and COM2 serial communication links. Although addresses need not be sequential, no two relays can have the same address. Generally each relay added to the link will use the next higher address, starting from address 1. No address is required to use the front panel program port since only one relay can be connected at one time.
- **COM1/COM2 BAUD RATE:** Select the baud rates for COM1, the RS485/RS422 communication port, or COM2. All relays on the communication link, and the computer connecting them, must run at the same baud rate. The fastest response is obtained at 19200 baud.
- **COM1/COM2 PARITY:** The data frame is fixed at 1 start, 8 data, and 1 stop bit. If required, a parity bit is programmable. The parity of the transmitted signal must match the parity displayed in this setpoint.
- **COM1 HARDWARE:** If the two-wire RS485 hardware configuration is required for the COM1 serial communication port, select RS485. If the four wire RS422 hardware configuration is required, select RS422.
- **FRONT BAUD RATE / FRONT PARITY:** Select the baud rate / parity for the front panel port.

5.3.3.3 DNP Communications

PATH: SETPOINTS ▷ S1 745 SETUP ▷ COMMUNICATIONS ▷ DNP

■ DNP	▷		DNP PORT: None	Range: None, COM1, COM2, Front
MESSAGE			DNP POINT MAPPING: Enabled	Range: Enabled, Disabled
MESSAGE			TRANSMISSION DELAY: 0 ms	Range: 0 to 65000 ms in steps of 1
MESSAGE			DATA LINK CONFIRM MODE: Never	Range: Never, Always, Sometimes
MESSAGE			DATA LINK CONFIRM TIMEOUT: 1000 ms	Range: 1 to 65000 ms in steps of 1
MESSAGE			DATA LINK CONFIRM RETRIES: 3	Range: 0 to 100 in steps of 1
MESSAGE			SELECT/OPERATE ARM TIMEOUT: 10000 ms	Range: 1 to 65000 ms in steps of 1
MESSAGE			WRITE TIME INTERVAL: 0 ms	Range: 0 to 65000 ms in steps of 1
MESSAGE			COLD RESTART INHIBIT: Disabled	Range: Enabled, Disabled

- **DNP PORT:** Selects the communication port for DNP communications.

- **DNP POINT MAPPING:** When enabled, the 120 User Map Values are included in the DNP Object 30 point list. For additional information, refer to GE Multilin publication number GEK-106636A: *745 Communications Guide*.
- **TRANSMISSION DELAY:** Select the minimum time from when a DNP request is received and a response issued. A value of zero causes the response to be issued as quickly as possible.
- **DATA LINK CONFIRM MODE:** Select the data link confirmation mode for responses sent by the 745. When “Sometimes” is selected, data link confirmation is only requested when the response contains more than one frame.
- **DATA LINK CONFIRM TIMEOUT:** Selects a desired timeout. If no confirmation response is received within this time, the 745 will re-send the frame if retries are still available.
- **DATA LINK CONFIRM RETRIES:** Select the maximum number of retries that will be issued for a given data link frame.
- **SELECT/OPERATE ARM TIMEOUT:** Select the duration of the select / operate arm timer.
- **WRITE TIME INTERVAL:** Select the time that must elapse before the 745 will set the ‘need time’ internal indication (IIN). After the time is written by a DNP master, the IIN will be set again after this time elapses. A value of zero disables this feature.
- **COLD RESTART INHIBIT:** When disabled, a cold restart request from a DNP master will cause the 745 to be reset. Enabling this setpoint will cause the cold restart request to initialize only the DNP sub-module.



When “Disabled” is selected, a cold restart request will cause loss of protection until the 745 reset completes.

5.3.3.4 Network Setup

PATH: SETPOINTS > S1 745 SETUP > COMMUNICATIONS > NETWORK SETUP

■ NETWORK SETUP [D]

IP ADDRESS:
 0.0.0.0

Range: standard IP address format

MESSAGE

SUBNET IP MASK:
 255.255.255.000

Range: standard IP address format

MESSAGE

GATEWAY IP ADDRESS:
 0.0.0.0

Range: standard IP address format



The IP addresses are used with the Modbus protocol. Enter the dedicated IP, subnet IP, and gateway IP addresses provided by the network administrator.

To ensure optimal response from the relay, the typical connection timeout should be set as indicated in the following table:

TCP/IP sessions	Timeout setting
up to 2	2 seconds
up to 4	3 seconds

5.3.4 Resetting

PATH: SETPOINTS ▷ S1 745 SETUP ▷ ▾ RESETTING





■ RESETTING ▷ MESSAGE 	 LOCAL RESET BLOCK: Disabled	Range: Enabled, Disabled
	 REMOTE RESET SIGNAL: Disabled	Range: Enabled, Disabled

The reset function performs the following actions: all latched relays are set to the non-operated state and latched target messages are cleared, if the initiating conditions are no longer present. Resetting can be performed in any of the following ways: via RESET on the front panel while the 745 is in local mode (i.e. the Local LED indicator is on); via a logic input; via any of the communication ports.

- **LOCAL RESET BLOCK:** The 745 is defaulted to the local mode. As a result, the front panel (local) RESET key is normally operational. Select any logic input, virtual input, output relay, or virtual output which, when asserted or operated, will block local mode, and hence the operation of the front panel RESET.
- **REMOTE RESET SIGNAL:** Select any logic input which, when asserted, will (remotely) cause a reset command.

5.3.5 Clock

PATH: SETPOINTS ▷ S1 745 SETUP ▷ ▾ CLOCK

■ CLOCK ▷ MESSAGE  MESSAGE 	 DATE (MM/DD/YYYY): 01/01/1996	Range: 1 to 12 / 1 to 31 / 1990 to 2089
	 TIME (HH:MM:SS): 00:00:00	Range: 0 to 23 : 0 to 59 : 0 to 59
	 IRIG-B SIGNAL TYPE: None	Range: None, DC Shift, Amplitude Modulated

A supercap-backed internal clock runs even when control power is lost. With control power off, the clock continues to run for 45 days. The clock is accurate to within 1 minute per month. An IRIG-B signal may be connected to the 745 to synchronize the clock to a known time base and to other relays. The clock performs time and date stamping for various relay features, such as event and last trip data recording. Without an IRIG-B signal, the current time and date must be entered in a new relay for any time and date displayed. If not entered, all message references to time or date will display “Unavailable”. With an IRIG-B signal, only the current year needs to be entered.

- **DATE:** Enter the current date, using two digits for the month, two digits for the day, and four digits for the year. For example, April 30, 1996 would be entered as “04 30 1996”. If entered from the front panel, the new date will take effect at the moment of pressing the ENTER key.
- **TIME:** Enter the current time by using two digits for the hour in 24 hour time, two digits for the minutes, and two digits for the seconds. The new time takes effect at the moment of pressing the ENTER key. For example, 3:05 PM is entered as “15 05 00”, with the ENTER key pressed at exactly 3:05 PM.
- **IRIG-B SIGNAL TYPE:** Select the type of IRIG-B signal being used for clock synchronization. Select “None” if no IRIG-B signal is to be used.

5.3.6 Default Messages

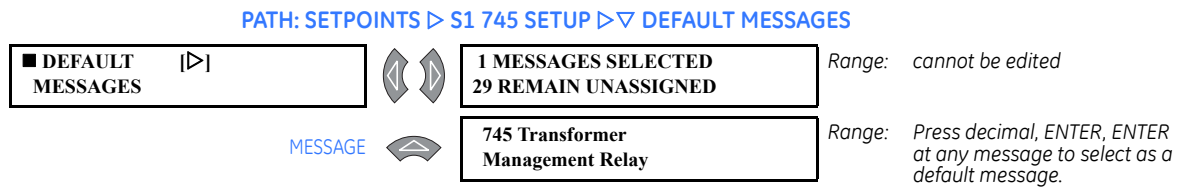

Under normal conditions, if no front panel keys have been pressed for longer than the time specified in [S1 745 SETUP ▷ ▾ PREFERENCES ▷ ▾ DEFAULT MESSAGE TIMEOUT](#), the screen begins to sequentially display up to thirty (30) user-selected default messages. In addition, up to 5 user programmable text messages can be assigned as default messages. For example, the relay could be set to sequentially display a text message identifying the transformer, the system status, the measured current in each phase, and the harmonic inhibit level. Currently selected default messages are viewed under [S1 745 SETUP ▷ ▾ DEFAULT MESSAGES](#). The first message in this section states the number of messages currently selected.

Default messages are added to the end of the default message list as follows:

- ▷ Allow access to setpoints by installing the setpoint access jumper and entering the correct passcode.
- ▷ Select the setpoint or actual value message to be entered as a default message, so that it is displayed.
If user text is required, go into [S1 745 SETUP ▷ ▾ SCRATCHPAD](#) and edit the text for default.
- ▷ Press the decimal key followed by **ENTER** while the message is displayed.
The screen will display [PRESS \[ENTER\] TO ADD AS DEFAULT](#).
- ▷ Press **ENTER** again while this message is being displayed.
The message is now added to the default message list.

Default messages are removed from the default message list as follows:

- ▷ Allow access to setpoints by installing the setpoint access jumper and entering the correct passcode.
- ▷ Select the message under the section [S1 745 SETUP ▷ ▾ DEFAULT MESSAGES](#) to remove from the default message list.
- ▷ Press the decimal key followed by **ENTER**.
The screen displays [PRESS \[ENTER\] TO REMOVE MESSAGE](#).
- ▷ Press **ENTER** while this message is being displayed.
The message is now removed from the default message list and the messages that follow are moved up to fill the gap.

5.3.7 Scratchpad

PATH: SETPOINTS > S1 745 SETUP > ▾ SCRATCHPAD

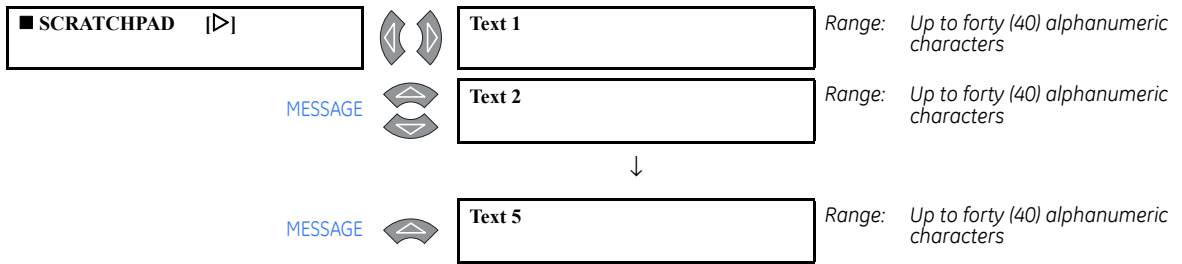

Up to five (5) message screens can be programmed and selected as default messages. These messages can be used to provide identification information about the system or instructions to operators.

- **TEXT 1 to TEXT 5:** Press ENTER to begin editing scratchpad messages 1 through 5. The text may be changed from “Text 1” one character at a time, using the VALUE keys. Press the ENTER key to store the edit and advance to the next character position. This message may then be stored as a default message.

5.3.8 Installation

PATH: SETPOINTS > S1 745 SETUP > ▾ INSTALLATION



To safeguard against the installation of a relay whose setpoints have not been entered, the 745 will not allow signaling of any output relay, will have the In Service LED off and the Self-Test Error LED on, until the 745 is set to “Programmed”. The setpoint is defaulted to “Not Programmed” when the relay leaves the factory. The **SETPOINTS HAVE NOT BEEN PROGRAMMED** self-test error message is displayed automatically until the 745 is put into the programmed state:

5.3.9 Upgrade Options

PATH: SETPOINTS > S1 745 SETUP > ▾ UPGRADE OPTIONS

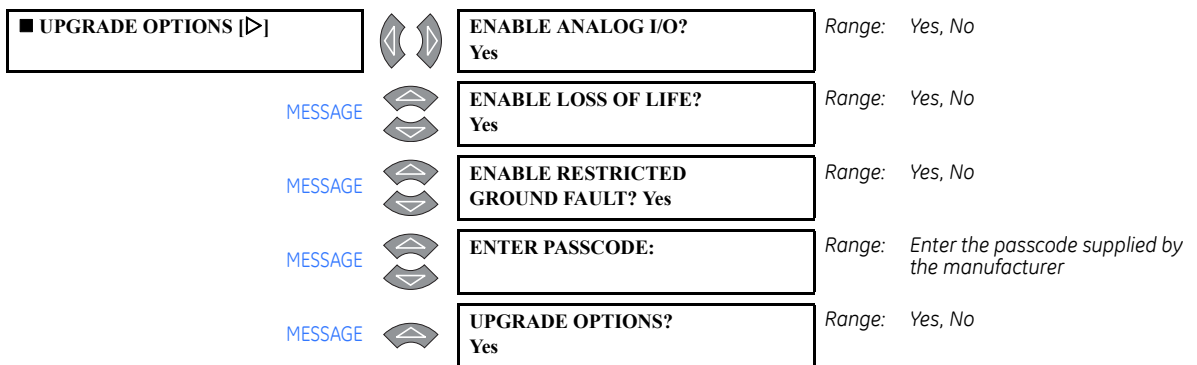

Some options may be added while the relay is in the field. These include the analog input/output, loss of life and restricted ground fault options. Should this be desired, contact the factory with the 745 order code and serial number (see [A4 PRODUCT INFO ▷▽ REVISION CODES ▷▽ INSTALLED OPTIONS](#) and [SERIAL NUMBER](#)) and the new option(s) to be added.







The factory will supply a passcode that may be used to add the new options to the 745. Before entering the passcode and performing the upgrade, it is important to set the [ENABLE](#) setpoints correctly (see descriptions below). Any options that are currently supported by the 745 as well as any options that are to be added should have the corresponding [ENABLE](#) setpoint set to “Yes”. All others must be set to “No”.

For example, if the 745 currently supports only the analog input/output option and the loss of life option is to be added, then the [ENABLE ANALOG I/O](#) setpoint and the [ENABLE LOSS OF LIFE](#) setpoint must be set to “Yes”. The [ENABLE RESTRICTED GROUND FAULT](#) setpoint must be set to “No”.

- **ENABLE ANALOG I/O:** Select “Yes” if the upgrade options set supports the analog input/output feature, otherwise select “No”. The default value for this setpoint reflects the current state of the option.
- **ENABLE LOSS OF LIFE:** Select “Yes” if the upgrade options set supports the loss of life feature and select “No” otherwise. The default value for this setpoint reflects the current state of the option.
- **ENABLE RESTRICTED GROUND FAULT:** Select “Yes” if the upgrade options set supports the restricted ground fault feature and select “No” otherwise. The default value for this setpoint reflects the current state of the option.
- **ENTER PASSCODE:** Press ENTER to begin entering the factory-supplied upgrade passcode. This setpoint has a textual format, thus it is edited in the same manner as, for example, the setpoints under [S1 745 SETUP ▷▽ SCRATCHPAD](#).
- **UPGRADE OPTIONS:** When all of the above setpoints are properly programmed, select “Yes” and press ENTER to prompt the 745 to upgrade its options. A flash message appears indicating the results of the upgrade. A successful upgrade may be verified by examining [A4 PRODUCT INFO ▷▽ REVISION CODES ▷▽ INSTALLED OPTIONS](#).

5.3.10 Setup Event Recorder

PATH: SETPOINTS ▷ S1 745 SETUP ▷ ▾ SETUP EVENT RECORDER

■ SETUP EVENT RECORDER ▷		PICKUP EVENT: Enabled	<i>Range: Enabled, Disabled</i>
MESSAGE		OPERATE EVENT: Enabled	<i>Range: Enabled, Disabled</i>
MESSAGE		DROPOUT EVENT: Enabled	<i>Range: Enabled, Disabled</i>
MESSAGE		ERROR EVENT: Enabled	<i>Range: Enabled, Disabled</i>
MESSAGE		OFF EVENT: Enabled	<i>Range: Enabled, Disabled</i>
MESSAGE		ON EVENT: Enabled	<i>Range: Enabled, Disabled</i>

These setpoints allow the user to configure the event recorder by enabling/disabling the event types indicated.













5.4 S2 System Setup

5.4.1 Description

This group of setpoints is critical for the protection features to operate correctly. When the relay is ordered, the phase and ground CT inputs must be specified as either 5 A or 1 A. The characteristics of the equipment installed on the system are entered on this page. This includes information on the transformer type, CTs, VT, ambient temperature sensor, onload tap changer, demand metering, analog outputs and analog input.

5.4.2 Transformer

PATH: SETPOINTS ▾ ▾ S2 SYSTEM SETUP ▸ TRANSFORMER

<div style="border: 1px solid black; padding: 2px; display: inline-block;"> ■ TRANSFORMER ▷ </div>			NOMINAL FREQUENCY: 60 Hz	<i>Range: 50 Hz, 60 Hz</i>
MESSAGE			FREQUENCY TRACKING: Enabled	<i>Range: Enabled, Disabled</i>
MESSAGE			PHASE SEQUENCE: ABC	<i>Range: ABC, ACB</i>
MESSAGE			TRANSFORMER TYPE: Y/d30°	<i>Range: Refer to Transformer types on page 5–13</i>
MESSAGE			LOAD LOSS AT RATED LOAD: 1250 kW	<i>Range: 0 to 20000 kW in steps of 1 (Auto-ranging; see table below)</i>
MESSAGE			LOW VOLTAGE WINDING RATING: Above 5 kV	<i>Range: Above 5 kV, 1 kV to 5 kV, Below 1 kV</i>
MESSAGE			RATED WINDING TEMP RISE: 65°C (oil)	<i>Range: 65°C (oil), 55°C (oil), 80°C (dry), 115°C (dry), 150°C (dry)</i>
MESSAGE			NO-LOAD LOSS: 125.0 kW	<i>Range: 0.1 to 2000.0 kW in steps of 0.1 (see description below)</i>
MESSAGE			TYPE OF COOLING: OA	<i>Range: FA, OA, Directed FOA/FOW, Non-Directed FOA/FOW</i>
MESSAGE			RATED TOP OIL RISE OVER AMBIENT: 10°C	<i>Range: 1 to 200°C in steps of 1</i>
MESSAGE			XFMR THRML CAPACITY: 1.00 kWh/°C	<i>Range: 0.00 to 200.00 kWh/°C in steps of 0.01</i>
MESSAGE			WINDING TIME CONST: 2.00 min.	<i>Range: 0.25 to 15.00 min. in steps of 0.01</i>
MESSAGE			SET ACCUMULATED LOSS OF LIFE: 0 x 10h	<i>Range: 0 to 20000 x 10h in steps of 1</i>

To provide accurate and effective transformer protection, the parameters of both the transformer and the system configuration must be supplied to the 745 relay.

- NOMINAL FREQUENCY:** Enter the nominal frequency of the power system. This setpoint is used to determine the sampling rate in the absence of a measurable frequency. Frequency is measured from the VT input when available. If the VT input is not available, current from Winding 1 Phase A is used.

- **FREQUENCY TRACKING:** In situations where the AC signals contain significant amount of sub-harmonic components, it may be necessary to disable frequency tracking.
- **PHASE SEQUENCE:** Enter the phase sequence of the power system. Systems with an ACB phase sequence require special considerations. See *Phase Shifts on Three-phase Transformers* on page 5–8 for details.
- **TRANSFORMER TYPE:** Enter the transformer connection from the table of transformer types. Phase correction and zero-sequence removal are performed automatically as required.



If **TRANSFORMER TYPE** is entered as “2W External Correction” or “3W External Correction” with a delta/bye power transformer, the **WINDING 1(3) PHASE CT PRIMARY** setting values must be divided by $\sqrt{3}$ on the delta current transformer side to compensate the current magnitude. With this correction, the 745 will properly compare line to neutral currents on all sides of the power transformer.

For example, for a two-winding delta/bye power transformer with bye-connected current transformers on the delta side of the power transformer (25000:5 ratio), and delta-connected current transformers on the bye side of the transformer (4000:5 ratio), set:

TRANSFORMER TYPE: “2W External Connection”

WINDING 1 PHASE CT PRIMARY: “25000:5”

WINDING 2 PHASE CT PRIMARY: $(4000 / \sqrt{3}):5$ or “2309:5”

- **LOAD LOSS AT RATED LOAD:** Enter the load loss at rated load. This value is used for calculation of harmonic derating factor, and in the Insulating Aging function. This is an auto-ranging setpoint dependent on the **LOW VOLTAGE WINDING RATING** value; see ranges in the following table

Setting	Low voltage winding rating		
	above 5 kV	1 kV to 5 kV	below 1 kV
MINIMUM TAP POSITION VOLTAGE	0.1 to 2000.0 kV in steps of 0.1	0.01 to 200.00 kV in steps of 0.01	0.001 to 20.000 kV in steps of 0.001
VOLTAGE INCREMENT PER TAP	0.01 to 20.00 kV in steps of 0.01	0.001 to 2.000 kV in steps of 0.001	0.0001 to 0.2000 kV in steps of 0.0001
LOAD LOSS AT RATED LOAD	1 to 20000 kW in steps of 0.1	0.1 to 2000.0 kW in steps of 0.01	0.01 to 200.00 kW in steps of 0.001
NO LOAD LOSS	0.1 to 2000.0 kW in steps of 1	0.01 to 200.00 kW in steps of 0.1	0.001 to 20.000 kW in steps of 0.01

- **LOW VOLTAGE WINDING RATING:** Enter the low voltage winding rating. This selection affects the ranges of **WINDING 1(3) NOM ϕ - ϕ VOLTAGE**, **WINDING 1(3) RATED LOAD**, **MINIMUM TAP POSITION VOLTAGE**, and **VOLTAGE INCREMENT PER TAP** as shown in the table above.
- **RATED WINDING TEMP RISE:** Determines the type of insulation; for use in the computation of insulation aging.
- **NO-LOAD LOSS:** From the transformer data. It is required for insulation aging calculations This is an auto-ranging setpoint dependent on the **LOW VOLTAGE WINDING RATING** value; see ranges in the above table.
- **TYPE OF COOLING:** From Transformer data; required for insulation aging calculations.
- **RATED TOP OIL RISE OVER AMBIENT:** Required for insulation aging calculations
- **XFMR THRML CAPACITY:** Required for insulation aging calculations. Obtain from transformer manufacturer

- **WINDING TIME CONST:** Required for insulation aging calculations
- **SET ACCUMULATED LOSS OF LIFE:** Required for insulation aging calculations. Set equal to the estimated accumulated loss of life.

5.4.3 Windings 1 to 3

PATH: SETPOINTS ▾ ▾ S2 SYSTEM SETUP ▾ ▾ WINDING 1(3)

■ WINDING 1 ▷		WINDING 1 NOM Φ-Φ VOLTAGE: 220.0 kV	Range: <i>Dependent on LOW VOLTAGE WINDING RATING; see below.</i>
MESSAGE		WINDING 1 RATED LOAD: 100.0 MVA	Range: <i>Dependent on LOW VOLTAGE WINDING RATING; see below.</i>
MESSAGE		WINDING 1 PHASE CT PRIMARY: 500:5 A	Range: <i>1 to 50000:5 A in steps of 1</i>
MESSAGE		WINDING 1 GROUND CT INPUT: NONE	Range: <i>None, G1/2, G2/3</i>
MESSAGE		WINDING 1 GROUND CT PRIMARY: 2000:1 A	Range: <i>1 to 50000:1 A in steps of 1</i>
MESSAGE		WINDING 1 SERIES 3Φ RESISTANCE: 10.700 Ω	Range: <i>0.001 to 50.000 Ω in steps of 0.001</i>

These setpoints describe the characteristics of each transformer winding and the CTs connected to them.



The above setpoint options are also available for the second and third winding. Winding 3 setpoints are only visible if the unit has the appropriate hardware and if the selected **TRANSFORMER TYPE** is a three-winding transformer.

- **WINDING 1(3) NOM Φ-Φ VOLTAGE:** Enter the nominal phase-to-phase voltage rating of Winding 1(3) of the transformer. The range for this setpoint is affected by the **S2 SYSTEM SETUP ▾ TRANSFORMER ▾ LOW VOLTAGE WINDING RATING** setting (see table below).
- **WINDING 1(3) RATED LOAD:** Enter the self-cooled load rating for winding 1(3) of the transformer. The range for this setpoint is affected by the **S2 SYSTEM SETUP ▾ TRANSFORMER ▾ LOW VOLTAGE WINDING RATING** setting (see the table below).

Setting	Low voltage winding rating value		
	above 5 kV	1 kV to 5 kV	below 1 kV
WINDING 1(3) NOM Φ-Φ VOLTAGE	0.1 to 2000.0 kV in steps of 0.1	0.01 to 200.00 kV in steps of 0.01	0.001 to 20.000 kV in steps of 0.001
WINDING 1(3) RATED LOAD	0.1 to 2000.0 MVA in steps of 0.1	0.01 to 200.00 MVA in steps of 0.01	0.001 to 20.000 MVA in steps of 0.001

- **WINDING 1(3) PHASE CT PRIMARY:** Enter the phase CT primary current rating of the current transformers connected to winding 1(3). The CT secondary current rating must match the relay phase current input rating indicated.
- **WINDING 1(3) GROUND INPUT SELECTION:** Select the ground CT (G1/2 or G2/3) for the particular winding required. Leave ground CT selection at default value of "None" if no CT is needed on the required winding.
The ground input selection settings will be defaulted to "None" when an upgrade settings file is uploaded.



This setting is visible only for a 3W transformer.



Whenever transformer type is changed (particularly from 2 W to 3 W) "ground input selection" setting should be cross-checked.

- **WINDING 1(3) GROUND CT PRIMARY:** Enter the ground CT primary current rating of the current transformers connected in the winding 1(3) neutral to ground path. The CT secondary current rating must match the relay ground current input rating indicated.
- **WINDING 1(3) SERIES 3-Φ RESISTANCE:** Enter the series three-phase resistance of the winding (that is, the sum of the resistance of each of the three phases for the winding). This value is normally only available from the transformer manufacturer’s test report, and is used in the 745 for calculation of harmonic derating factor.

5.4.4 Onload Tap Changer

PATH: SETPOINTS ▾ ▾ S2 SYSTEM SETUP ▾ ▾ ONLOAD TAP CHANGER

<div style="border: 1px solid black; padding: 2px;"> ONLOAD TAP CHANGER </div>		<div style="border: 1px solid black; padding: 2px;"> WINDING WITH TAP CHANGER: None </div>	<i>Range: None, Winding 1, Winding 2, Winding 3</i>	
	MESSAGE		<div style="border: 1px solid black; padding: 2px;"> NUMBER OF TAP POSITIONS: 33 </div>	<i>Range: 2 to 50 in steps of 1</i>
	MESSAGE		<div style="border: 1px solid black; padding: 2px;"> MINIMUM TAP POSITION VOLTAGE: 61.0 kV </div>	<i>Range: Dependent on LOW VOLTAGE WINDING RATING; see below.</i>
	MESSAGE		<div style="border: 1px solid black; padding: 2px;"> VOLTAGE INCREMENT PER TAP: 0.50 kV </div>	<i>Range: Dependent on LOW VOLTAGE WINDING RATING; see below.</i>
	MESSAGE		<div style="border: 1px solid black; padding: 2px;"> RESISTANCE INCREMENT PER TAP: 33 Ω </div>	<i>Range: 10 to 500 Ω in steps of 1</i>

This section contains the settings to configure the tap position input. The 745 accepts a resistive input from the tap changer control circuitry, which is used in the 745 to dynamically correct for CT ratio mismatch based on the dynamically changing voltage ratio of the transformer. Thus, the percent differential function of the device can be set for greater sensitivity. See *Dynamic CT Ratio Mismatch Correction* on page 5–6 for more details on the tap position input.

- **WINDING WITH TAP CHANGER:** Enter the winding with the tap changer. Enter 'None' for a transformer with no onload tap changer, or to disable this feature.
- **NUMBER OF TAP POSITIONS:** Enter the number of tap positions here.
- **MINIMUM TAP POSITION VOLTAGE:** Enter the voltage at the lowest tap position. This is an auto-ranging setpoint dependent on [S2 SYSTEM SETUP ▾ TRANSFORMER ▾ ▾ LOW VOLTAGE WINDING RATING](#); see ranges in the table below.
- **VOLTAGE INCREMENT PER TAP:** Enter the voltage increment for each tap. The range is affected by the setpoint. This is an auto-ranging setpoint dependent on the [S2 SYSTEM SETUP ▾ TRANSFORMER ▾ ▾ LOW VOLTAGE WINDING RATING](#) value; see ranges in the following table:

Setting	Low voltage winding rating value		
	above 5 kV	1 kV to 5 kV	below 1 kV
MINIMUM TAP POSITION VOLTAGE	0.1 to 2000.0 kV in steps of 0.1	0.01 to 200.00 kV in steps of 0.01	0.001 to 20.000 kV in steps of 0.001

Setting	Low voltage winding rating value		
	above 5 kV	1 kV to 5 kV	below 1 kV
VOLTAGE INCREMENT PER TAP	0.01 to 20.00 kV in steps of 0.01	0.001 to 2.000 kV in steps of 0.001	0.0001 to 0.2000 kV in steps of 0.0001

- **RESISTANCE INCREMENT PER TAP:** Enter the resistance increment that the 745 will see for each tap increment. The maximum resistance value for the top tap is 5 KΩ.

5.4.5 Harmonics

PATH: SETPOINTS ▾ ▾ S2 SYSTEM SETUP ▾ ▾ HARMONICS

■ HARMONICS ▷ MESSAGE MESSAGE		HARMONIC DERATING ESTIMATION: Disabled Range: Enabled, Disabled
		THD MINIMUM HARMONIC NUMBER: 2nd Range: 2nd, 3rd, 4th,..., 21st
		THD MAXIMUM HARMONIC NUMBER: 2nd Range: 2nd, 3rd, 4th,..., 21st

The 745 calculates the individual harmonics in each of the phase current inputs up to the 21st harmonic. With this information, it calculates an estimate of the effect of non-sinusoidal load currents on the transformer rated full load current. These calculations are based on ANSI/IEEE Standard C57.110-1986, and require information that is often only available from the transformer manufacturer’s test report, including the three-phase resistance of each winding and the load loss at rated load. The harmonic derating factor will only be valid if this information has been entered correctly.

The 745 also calculates the total harmonic distortion of the phase current input signals. The band of frequencies over which this calculation is made can be changed to be more selective than the default 2nd to 21st harmonics.

- **HARMONIC DERATING FUNCTION:** Enter “Enabled” to enable the harmonic derating factor calculations.
- **THD MINIMUM/MAXIMUM HARMONIC NUMBER** Enter the minimum/maximum harmonic number of the frequency band over which total harmonic distortion is calculated.

5.4.6 FlexCurves™

PATH: SETPOINTS ▾ ▾ S2 SYSTEM SETUP ▾ ▾ FLEXCURVES ▾ FLEXCURVE A(C)

■ FLEXCURVE A ▷ MESSAGE MESSAGE		FLEXCURVE A DELAY AT 1.03 x PU: 0 ms Range: 0 to 65000 ms in steps of 1
		FLEXCURVE A DELAY AT 1.05 x pu: 0 ms Range: 0 to 65000 ms in steps of 1
		FLEXCURVE A DELAY AT 20.0 x pu: 0 ms Range: 0 to 65000 ms in steps of 1

Three programmed custom FlexCurves™ can be stored in the 745 as FlexCurve™ A, FlexCurve™ B, and FlexCurve™ C. This allows the user to save special curves for specific applications and then select them as required for time overcurrent element curves. The

custom FlexCurve™ has setpoints for entering the times-to-trip at various levels of pickup. The levels are as follows: 1.03, 1.05, 1.1 to $6.0 \times pu$ in steps of 0.1, and 6.5 to $20.0 \times pu$ in steps of 0.5.

- **FLEXCURVE A DELAY AT $n \times PU$:** Enter the trip time for $n = 1.03, 1.05, \dots, 20.0 \times pu$ for FlexCurve™ A(C). The messages that follow sequentially correspond to the trip times for the various pickup levels as indicated above.

5.4.7 Voltage Input

PATH: SETPOINTS ▾ S2 SYSTEM SETUP ▾ VOLTAGE INPUT

■ VOLTAGE INPUT [▷]		VOLTAGE SENSING: Disabled	Range: Enabled, Disabled
MESSAGE		VOLTAGE INPUT PARAMETER: W1 Van	Range: W1, W2, W3; Van, Vbn, Vcn, Vab, Vbc, Vca
MESSAGE		NOMINAL VT SECONDARY VOLTAGE: 120.0 V	Range: 60.0 to 120.0 in steps of 0.1
MESSAGE		VT RATIO: 1000:1	Range: 1 to 5000:1 in steps of 1

The 745 provides a voltage input for the purposes of energization detection (for the energization inhibit feature of the percent differential element), overexcitation protection (the volts-per-hertz 1 and 2 functions), and frequency protection (the underfrequency, frequency decay, and overfrequency functions). Note that the frequency elements will use the winding 1 phase A current input if voltage is not available.

- **VOLTAGE INPUT PARAMETER:** Enter the winding and phase of the voltage connected to the voltage input.
- **NOMINAL VT SECONDARY VOLTAGE:** Enter the nominal secondary voltage (in volts) of the voltage transformer.
- **VT RATIO:** Enter the ratio of the voltage transformer.

5.4.8 Ambient Temperature

PATH: SETPOINTS ▾ S2 SYSTEM SETUP ▾ AMBIENT TEMP

■ AMBIENT TEMP [▷]		AMBIENT TEMPERATURE SENSING: Disabled	Range: Enabled, Disabled
MESSAGE		AMBIENT RTD TYPE: 100 Ω Platinum	Range: 100 Ω Platinum, 120 Ω Nickel, 100 Ω Nickel, By Monthly Average
MESSAGE		AVERAGE AMBIENT TEMP FOR JANUARY: 20°C	Range: -50 to 125°C in steps of 1
		↓	
MESSAGE		AVERAGE AMBIENT TEMP FOR DECEMBER: 20°C	Range: -50 to 125°C in steps of 1

- **AMBIENT RTD SENSING:** Select “Enabled” to use an RTD to monitor ambient temperature.

- **AMBIENT RTD TYPE:** The 745 provides an RTD input for monitoring the ambient temperature. The three RTD types which may be used are 100 Ω platinum, and 100/120 Ω nickel, the characteristics of which are as follows:

Table 5-3: RTD resistance vs. temperature

Temperature	100 Ω Platinum	120 Ω Nickel	100 Ω Nickel
-50°C	80.31 Ω	86.17 Ω	71.81 Ω
-40°C	84.27 Ω	92.76 Ω	79.13 Ω
-30°C	88.22 Ω	99.41 Ω	84.15 Ω
-20°C	92.16 Ω	106.15 Ω	89.23 Ω
-10°C	96.09 Ω	113.00 Ω	94.58 Ω
0°C	100.00 Ω	120.00 Ω	100.00 Ω
10°C	103.90 Ω	127.17 Ω	105.60 Ω
20°C	107.79 Ω	134.52 Ω	111.20 Ω
30°C	111.67 Ω	142.06 Ω	117.10 Ω
40°C	115.54 Ω	149.79 Ω	123.01 Ω
50°C	119.39 Ω	157.74 Ω	129.11 Ω
60°C	123.24 Ω	165.90 Ω	135.34 Ω
70°C	127.07 Ω	174.25 Ω	141.72 Ω
80°C	130.89 Ω	182.84 Ω	148.25 Ω
90°C	134.70 Ω	191.64 Ω	154.90 Ω
100°C	138.50 Ω	200.64 Ω	161.78 Ω
110°C	142.29 Ω	209.85 Ω	168.79 Ω
120°C	146.06 Ω	219.29 Ω	175.98 Ω
130°C	149.82 Ω	228.96 Ω	183.35 Ω
140°C	153.58 Ω	238.85 Ω	190.90 Ω
150°C	157.32 Ω	248.95 Ω	198.66 Ω
160°C	161.04 Ω	259.30 Ω	206.62 Ω
170°C	164.76 Ω	269.91 Ω	214.81 Ω
180°C	168.47 Ω	280.77 Ω	223.22 Ω
190°C	172.46 Ω	291.96 Ω	243.30 Ω
200°C	175.84 Ω	303.46 Ω	252.88 Ω
210°C	179.51 Ω	315.31 Ω	262.76 Ω
220°C	183.17 Ω	327.54 Ω	272.94 Ω
230°C	186.82 Ω	340.14 Ω	283.94 Ω
240°C	190.45 Ω	353.14 Ω	294.28 Ω
250°C	194.08 Ω	366.53 Ω	305.44 Ω

- **AVERAGE AMBIENT TEMPERATURE (BY MONTH):** This message is displayed only when the **AMBIENT RTD TYPE** is set for "By Monthly Average". Ambient temperature is used in the calculation of Insulation Aging and must be enabled for the function to operate.

5.4.9 Analog Input

PATH: SETPOINTS ▾ ▾ S2 SYSTEM SETUP ▾ ▾ ANALOG INPUT

■ ANALOG INPUT [▷]		ANALOG INPUT NAME: Analog Input	Range: 18 alphanumeric characters
MESSAGE		ANALOG INPUT UNITS: μA	Range: 6 alphanumeric characters
MESSAGE		ANALOG INPUT RANGE: 0-1 mA	Range: 0-1 mA, 0-5 mA, 4-20 mA, 0-20 mA.
MESSAGE		ANALOG INPUT MINIMUM VALUE: 0 μA	Range: 0 to 65000 in steps of 1
MESSAGE		ANALOG INPUT MAXIMUM VALUE: 1000 μA	Range: 0 to 65000 in steps of 1

The 745 provides a general purpose DC current input for use in monitoring any external parameter. Any standard transducer output may be connected to the analog input for monitoring.

- **ANALOG INPUT NAME:** Press ENTER to begin editing the name of the analog input. The text may be changed from “Analog Input” one character at a time, using the VALUE keys. Press the ENTER key to store the edit and advance to the next character position. This name will appear in the actual value message [A2 METERING ▾ ▾ ANALOG INPUT](#).
- **ANALOG INPUT UNITS:** Enter the units of the quantity being read by editing the text as described above. The six characters entered will be displayed instead of “Units” wherever the analog input units are displayed.
- **ANALOG INPUT RANGE:** Select the current output range of the transducer that is connected to the analog input. The units are defined by the [ANALOG INPUT UNITS](#) setpoint.
- **ANALOG INPUT MINIMUM/MAXIMUM:** Enter the value of the quantity measured which corresponds to the minimum/maximum output value of the transducer. The units are defined by the [ANALOG INPUT UNITS](#) setpoint.

5.4.10 Demand Metering

PATH: SETPOINTS ▾ ▾ S2 SYSTEM SETUP ▾ ▾ DEMAND METERING

■ DEMAND METERING [▷]		CURRENT DEMAND METER TYPE: Thermal	Range: Thermal, Block Interval, Rolling Demand
MESSAGE		THERMAL 90% RESPONSE TIME: 15 min.	Range: 5, 10, 15, 20, 25, 30, 60 min.
MESSAGE		TIME INTERVAL: 20 min.	Range: 5, 10, 15, 20, 25, 30, 60 min. (see note below)

This section assigns the demand setpoints for monitoring current demand on all three phases of each windings. Current demand on the 745 is performed one of three ways: thermal, rolling demand, or block interval.

- **CURRENT DEMAND METER TYPE:** Select the method to be used for the current demand metering.

Select “Thermal” to emulate the action of an analog peak-recording thermal demand meter. The 745 measures the current on each phase every second, and assumes the circuit quantity remains at this value until updated by the next measurement. It calculates the ‘thermal demand equivalent’ as follows:

$$d(t) = D(1 - e^{-kt}) \quad (\text{EQ 5.3})$$

where d = demand after applying input for time t (in minutes)
 D = input quantity (constant)

$$k = \frac{2.3}{\text{Thermal 90\% Response Time}}$$

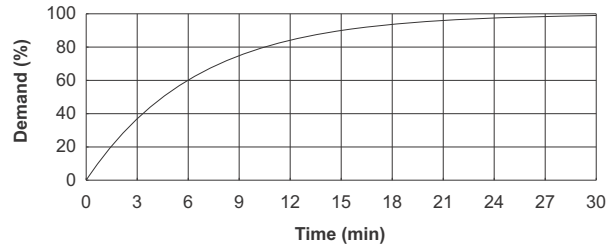

FIGURE 5–6: Thermal demand time

Select “Block Interval” to calculate a linear average of the current over the programmed demand **TIME INTERVAL**, starting daily at 00:00:00 (that is, 12 am). The 1440 minutes per day is divided into the number of blocks as set by the programmed time interval. Each new value of demand becomes available at the end of each time interval.

Select “Rolling Demand” to calculate a linear average of the current over the programmed demand **TIME INTERVAL** (in the same way as Block Interval above). The value is updated every minute and indicates the demand over the time interval just preceding the time of update.

- **THERMAL 90% RESPONSE TIME:** This message is displayed only when the **CURRENT DEMAND METER TYPE** is set for “Thermal”. Enter the time required for a steady-state current to indicate 90% of actual value.
- **TIME INTERVAL:** This message is displayed only when the **CURRENT DEMAND METER TYPE** is set for “Block Interval” or “Rolling Demand”. Enter the time period over which the current demand calculation is performed.



The **TIME INTERVAL** is only displayed when “Block Interval” or “Rolling Demand” is selected for the **CURRENT DEMAND METER TYPE**.

5.4.11 Analog Outputs 1 to 7

PATH: SETPOINTS ▾ ▾ S2 SYSTEM SETUP ▾ ▾ ANALOG OUTPUTS ▾ ANALOG OUTPUT 1(7)

■ ANALOG OUTPUT 1 [▷]		ANALOG OUTPUT 1 FUNCTION: Disabled	Range: Enabled, Disabled
MESSAGE		ANALOG OUTPUT 1 VALUE: W1 Φ A Current	Range: see table below
MESSAGE		ANALOG OUTPUT 1 RANGE: 4-20 mA	Range: 0-1 mA, 0-5 mA, 4-20 mA, 0-20 mA, 0-10 mA
MESSAGE		ANALOG OUTPUT 1 MIN: 0 A	Range: matches the range of the selected measured parameter
MESSAGE		ANALOG OUTPUT 1 MAX: 1000 A	Range: matches the range of the associated actual value

There are seven analog outputs on the 745 relay which are selected to provide a full-scale output range of one of 0 to 1 mA, 0 to 5 mA, 4 to 20 mA, 0 to 20 mA or 0 to 10 mA. Each channel can be programmed to monitor any measured parameter. This sub-section is only displayed with the option installed.

- **ANALOG OUTPUT 1(7) FUNCTION:** This message enables or disables the analog output 1(7) feature. When disabled, 0 mA will appear at the corresponding terminal.
- **ANALOG OUTPUT 1(7) VALUE:** Select the measured parameter below to be represented by the mA DC current level of analog output 1(7).

Parameter	Description
W1(3) Φ A Current W1(3) Φ B Current W1(3) Φ C Current	Select to monitor the RMS value (at fundamental frequency) of the winding 1(3) Phase A, B, and C current inputs.
W1(3) Loading	Select to monitor the winding 1(3) load as a percentage of the rated load for that winding.
W1(3) Φ A THD W1(3) Φ B THD W1(3) Φ C THD	Select to monitor the total harmonic distortion in the winding 1(3) phase A, B, and C current inputs.
W1(3) Derating	Select to monitor the harmonic derating factor (that is, the derated transformer capability while supplying non-sinusoidal load currents) in winding 1(3).
Frequency	Select to monitor the system frequency.
Tap Position	Select to monitor the on-load tap changer position.
Voltage	Select to monitor the system voltage as measured from the voltage input.
W1(3) Φ A Demand W1(3) Φ B Demand W1(3) Φ C Demand	Select to monitor the current demand value of the winding 1(3) phase A, B, and C current inputs.
Analog Input	Select to monitor the general purpose analog input current.
MaxEvt W1(3) Ia MaxEvt W1(3) Ib MaxEvt W1(3) Ic MaxEvt W1(3) Ia	Select to monitor the maximum captured RMS value (at fundamental frequency) of the winding 1(3) phase A, B, C, and ground current input for all events since the last time the event recorder was cleared.

- **ANALOG OUTPUT 1(7) RANGE:** Select the full-scale range of output current for analog output 1(7).
- **ANALOG OUTPUT 1(7) MIN/MAX:** Enter the value of the selected parameter which corresponds to the minimum/maximum output current of analog output 1(7).

5.5 S3 Logic Inputs







5.5.1 Description

There are two types of digital inputs: *Logic inputs* have physical terminals for connecting to external contacts; *Virtual inputs* provide the same function as logic inputs, but have no physical external connections. A setpoint defines the state of each in virtual input in terms of “On” or “Off”.

There are sixteen each of logic and virtual inputs. The state (‘asserted’ or ‘not asserted’) of each logic or virtual input can be used to activate a variety of predefined logic functions, such as protection element blocking, energization detection, etc. In addition, any logic or virtual input can be used as an input in FlexLogic™ equations to implement custom schemes.

5.5.2 Logic Inputs 1 to 16





PATH: SETPOINTS ▷ S3 LOGIC INPUTS ▷ LOGIC INPUTS ▷ LOGIC INPUT 1(16)

<div style="border: 1px solid black; padding: 2px;"> ■ LOGIC INPUT 1 [▷] </div>	 	INPUT 1 FUNCTION: Disabled	<i>Range: Enabled, Disabled</i>
MESSAGE	 	INPUT 1 TARGET: Self-Reset	<i>Range: None, Latched, Self-Reset</i>
MESSAGE	 	INPUT 1 NAME: Logic Input 1	<i>Range: 18 alphanumeric characters</i>
MESSAGE		INPUT 1 ASSERTED STATE: Closed	<i>Range: Open, Closed</i>

- **INPUT 1(16) FUNCTION:** Select “Enabled” if this logic input is to be used. Selecting “Disabled” prevents this logic input from achieving the asserted (or signaling) state.
- **INPUT 1(16) TARGET:** Selecting “None” inhibits target message display when the input is asserted. Thus, an input with target type “None” never disables the LED self-test feature since it cannot generate a displayable target message.
- **INPUT 1(16) NAME:** Press ENTER to edit the logic input name. The text may be changed from “Logic Input 1” one character at a time with the VALUE keys. Press ENTER to store and advance to the next character position.
- **INPUT 1(16) ASSERTED STATE:** Select “Closed” as when connected to a normally open contact (where the signaling state is closed). Select “Open” when connected to a normally closed contact (where the signaling state is open).

5.5.3 Virtual Inputs 1 to 16

PATH: SETPOINTS ▷ S3 LOGIC INPUTS ▷ VIRTUAL INPUTS ▷ VIRTUAL INPUTS 1(16)

■ VIRTUAL INPUT 1 ▷ MESSAGE MESSAGE MESSAGE		INPUT 1 FUNCTION: Disabled	<i>Range: Enabled, Disabled</i>
		INPUT 1 TARGET: Self-Reset	<i>Range: None, Latched, Self-Reset</i>
		INPUT 1 NAME: Virtual Input 1	<i>Range: 18 alphanumeric characters</i>
		INPUT 1 PROGRAMMED STATE: Not Asserted	<i>Range: Not Asserted, Asserted</i>

- **INPUT 1(16) FUNCTION:** Select “Enabled” if this virtual input is to be used. Selecting “Disabled” prevents this virtual input from achieving the asserted (or signaling) state.
- **INPUT 1(16) TARGET:** Selecting “None” inhibits target message display when the input is asserted. Thus, an input whose target type is “None” never disables the LED self-test feature since it cannot generate a displayable target message.
- **INPUT 1(16) NAME:** Press ENTER to edit the login input name. The text may be changed from “Virtual Input 1” one character at a time with the VALUE keys. Press ENTER to store and advance to the next character position.
- **INPUT 1(16) PROGRAMMED STATE:** Select “Asserted” to place the virtual input into the signaling state; likewise, select “Not Asserted” to place it into the non-signaling state.

5.6 S4 Elements

5.6.1 Introduction to Elements

Protection and monitoring elements are configured in this page. This includes complete differential protection; phase, neutral, ground, negative sequence overcurrent; restricted ground fault (differential ground); under, over, and rate-of-change of frequency; overexcitation; harmonic monitoring; analog input monitoring; current demand monitoring; and transformer overload monitoring.

Each element is comprised of a number of setpoints, some of which are common to all elements. These common setpoints are described below, avoiding repeated descriptions throughout this section:

<p><NAME OF ELEMENT> FUNCTION: Enabled</p>	<p><i>Range: Disabled, Enabled</i></p> <p>Select "Enabled" to enable the element. For critical protection elements, this setpoint is normally "Enabled" except for test purposes. For elements which are not to be used, this setpoint should be set to "Disabled".</p>
<p><NAME OF ELEMENT> RLYS (1-8):</p>	<p><i>Range: 1 TO 8</i></p> <p>Select output relay to be configured for the element.</p>
<p><NAME OF ELEMENT> TARGET: Latched</p>	<p><i>Range: Self-reset, Latched, None</i></p> <p>Target messages indicate which elements have picked up or operated. Select "Latched" to keep the element target message in the queue of target messages, even after the condition which caused the element to operate has been cleared, until a reset command is issued. Select "Self-reset" to automatically remove the target message from the message queue after the condition has been cleared. Select "None" to inhibit the display of the target message when the element operates. An element whose target type is "None" will never disable the LED self-test feature because can not generate a displayable target message.</p>
<p><NAME OF ELEMENT> BLOCK: Disabled</p>	<p><i>Range: Disabled, Logic Inpt 1 to 16, Virt Inpt 1 to 16, Output Rly 1 to 8, SelfTest Rly, Virt Output 1 to 5</i></p> <p>Select any logic input, virtual input, output relay, or virtual output which, when asserted or operated, blocks the element from operating. Selecting a logic or virtual input allows blocking the element based on a decision external to the 745. Selecting an output relay or virtual output allows blocking the element based on conditions detected by the 745 and the combination of logic programmed in the associated FlexLogic™ equation.</p>

Following the setpoint descriptions are logic diagrams illustrating how each setpoint, input parameter, and internal logic is used in a feature to obtain an output. The logic diagrams are organized into the following functional blocks:

SETPOINTS

- Shown as a block with the heading SETPOINT.
- The exact wording of the displayed setpoint message identifies the setpoint.
- Major functional setpoint selections are listed below the name and are incorporated in the logic.

MEASUREMENT UNITS

- Shown as a block with inset labelled RUN.
- The associated pickup or dropout setpoint is shown directly above.
- Operation of the detector is controlled by logic entering the RUN inset.
- Relationship between setpoint and input parameter is indicated by simple mathematical symbols: <, >, etc.

TIME DELAYS

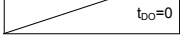
- Shown as a block with the following schematic symbol: 
- The delay before pickup is indicated by t_{PKP} , and the delay after dropout is indicated by t_{DO} .
- If the delay before pickup is adjustable, the associated delay setpoint is shown directly above, and the schematic symbol indicates that $t_{PKP} = DELAY$.

LED INDICATORS

- Shown as the following schematic symbol: 
- The exact wording of the front panel label identifies the indicator.

LOGIC

- Described using basic AND gates and OR gates

5.6.2 Setpoint Group

PATH: SETPOINTS ▾ ▾ S4 ELEMENTS ▾ SETPOINT GROUP

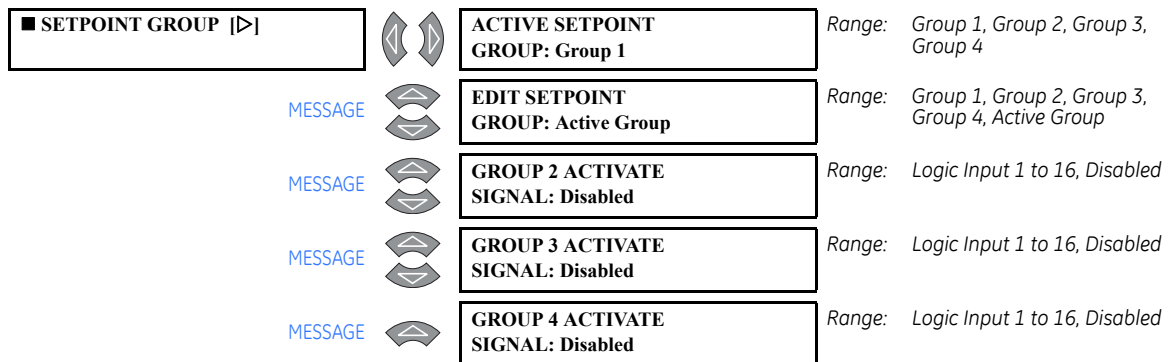

Each protection and monitoring element setpoint (programmed in S4 ELEMENTS) has four copies, and these settings are organized in four setpoint groups. Only one group of settings are active in the protection scheme at a time. The active group can be selected using the ACTIVE SETPOINT GROUP setpoint or using a logic input. The setpoints in any group can be viewed or edited using the EDIT SETPOINT GROUP setpoint.

- **ACTIVE SETPOINT GROUP:** Select the number of the SETPOINT GROUP whose settings are to be active in the protection scheme. This selection will be overridden if a higher number setpoint group is activated using logic inputs.

- **EDIT SETPOINT GROUP:** Select the number of the **SETPOINT GROUP** whose settings are to be viewed and/or edited via the front panel keypad or any of the communication ports. Selecting “Active Group” selects the currently active setpoint group for editing.
- **GROUP 2(4) ACTIVATE SIGNAL:** Select any logic input which, when asserted, will (remotely) select **SETPOINT GROUP 2(4)** to be the active group. This selection will be overridden if a higher number setpoint group is activated using the **ACTIVE SETPOINT GROUP** setpoint or another logic input.

5.6.3 Differential Element

5.6.3.1 Main menu

PATH: SETPOINTS ▷ S4 ELEMENTS ▷ DIFFERENTIAL

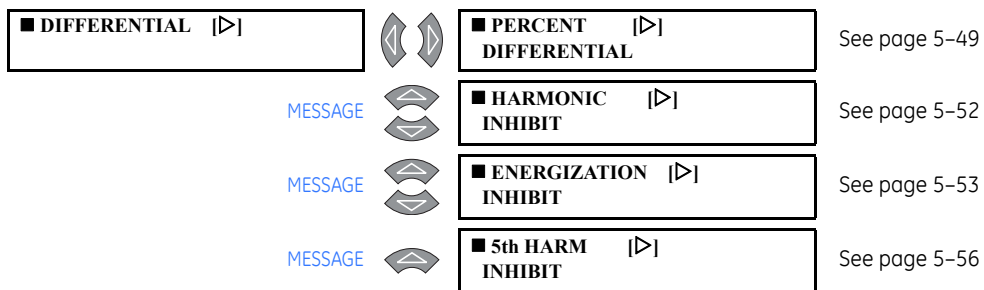

This section contains the settings to configure the percent differential element, including all associated harmonic inhibit features. The 745 provides three independent harmonic inhibit features: **HARMONIC INHIBIT**, which implements an inhibit scheme based on 2nd or 2nd + 5th harmonic which is ‘in-circuit’ at all times; **ENERGIZATION INHIBIT**, which allows changing the characteristics of the inhibit scheme during energization to improve reliability; and **5TH HARM INHIBIT**, which implements an inhibit scheme based on 5th harmonic only, allowing inhibiting the percent differential during intentional overexcitation of the system.

5.6.3.2 Percent Differential

PATH: SETPOINTS ▾ ▾ S4 ELEMENTS ▾ ▾ DIFFERENTIAL ▾ PERCENT DIFFERENTIAL

■ PERCENT DIFFERENTIAL [▷]	⏪ ⏩	PERCENT DIFFERENTIAL FUNCTION: Enabled	Range: Enabled, Disabled
MESSAGE	⏪ ⏩	PERCENT DIFFERENTIAL RLYS (1-8): -----	Range: 1 to 8
MESSAGE	⏪ ⏩	PERCENT DIFFERENTIAL TARGET: Latched	Range: Self-Reset, Latched, None
MESSAGE	⏪ ⏩	PERCENT DIFFERENTIAL PICKUP: 0.30 x CT	Range: 0.05 to 1.00 x CT in steps of 0.01
MESSAGE	⏪ ⏩	PERCENT DIFFERENTIAL SLOPE 1: 25%	Range: 15 to 100% in steps of 1
MESSAGE	⏪ ⏩	PERCENT DIFFERENTIAL KNEEPOINT: 2.0 x CT	Range: 1.0 to 20.0 x CT in steps of 0.1
MESSAGE	⏪ ⏩	PERCENT DIFFERENTIAL SLOPE 2: 100%	Range: 50 to 100% in steps of 1
MESSAGE	⏪ ⏩	PERCENT DIFFERENTIAL BLOCK: Disabled	Range: Logc Inpt 1 to 16, Virt Inpt 1 to 16, Output Rly 2 to 8, SelfTest Rly, Vir Outpt 1 to 5, Disabled

This section contains the settings to configure the percent differential element. The main purpose of the percent-slope characteristic of the differential element is to prevent maloperation because of unbalances between CTs during external faults. These unbalances arise as a result of the following factors:

- CT ratio mismatch (not a factor, since the 745 automatically corrects for this mismatch)
- Onload tap changers which result in dynamically changing CT mismatch
- CT accuracy errors
- CT saturation

The basic operating principle of the percent differential element can be described by the following diagram and its associated equations:

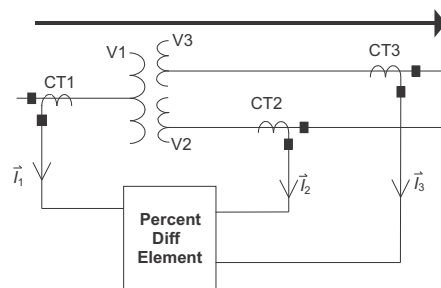

FIGURE 5-7: Percent differential operating principle



Restraint current calculations have been changed from average to maximum to provide better security during external faults.

The basic percent differential operating principle for three-winding transformers is illustrated by the following equations:

$$I_r = I_{restraint} = \max(|\vec{I}_1|, |\vec{I}_2|, |\vec{I}_3|); I_d = I_{differential} = |\vec{I}_1 + \vec{I}_2 + \vec{I}_3|$$

$$\%slope = \frac{I_d}{I_r} \times 100\%$$
(EQ 5.4)

The basic percent differential operating principle for two-winding transformers is illustrated by the following equations:

$$I_r = I_{restraint} = \max(|\vec{I}_1|, |\vec{I}_2|); I_d = I_{differential} = |\vec{I}_1 + \vec{I}_2|$$

$$\%slope = \frac{I_d}{I_r} \times 100\%$$
(EQ 5.5)

where $I_{restraint}$ = per-phase **maximum** of the currents after phase, ratio, and zero-sequence correction;
 $I_{differential}$ = per-phase **vector sum** of currents after phase, ratio, and zero-sequence correction



In the above equations, the 180° phase shift due to the wiring connections is taken into account, hence the + sign to obtain the differential current.

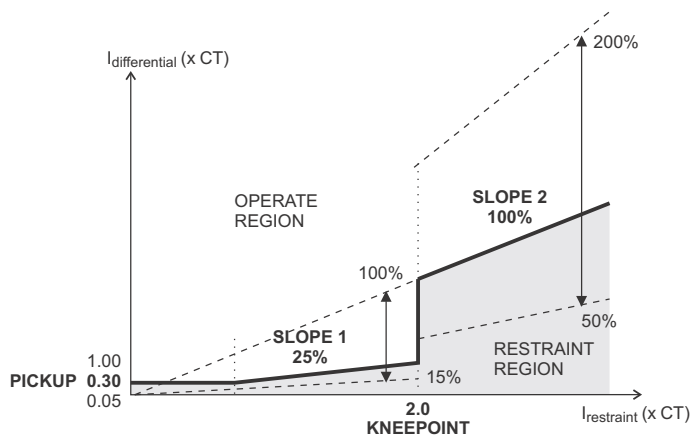

FIGURE 5-8: Percent differential dual-slope characteristic

The base for the percent differential setpoints is the [S2 SYSTEM SETUP ▾ ▽ WINDING 1 ▾ ▽ WINDING 1 PHASE CT PRIMARY](#) setpoint value. The percent differential setpoints are explained below.

- **PERCENT DIFFERENTIAL PICKUP:** Enter the minimum differential current required for operation. This setting is chosen based on the amount of differential current that might be seen under normal operating conditions.
- **PERCENT DIFFERENTIAL SLOPE 1:** Enter the slope 1 percentage (of differential current to restraint current) for the dual-slope percent differential element. The slope 1 setting is applicable for restraint currents of zero to the kneepoint, and defines the ratio of differential to restraint current above which the element will operate. This slope is set to ensure sensitivity to internal faults at normal operating current levels. The criteria for setting this slope are:

- To allow for mismatch when operating at the limit of the transformer’s onload tap-changer range.
- To accommodate for CT errors.
- **PERCENT DIFFERENTIAL KNEEPOINT:** Enter the kneepoint for the dual-slope percent differential element. This is the transition point between slopes 1 and 2, in terms of restraint current, in units of relay nominal current. Set the kneepoint just above the maximum operating current level of the transformer between the maximum forced-cooled rated current and the maximum emergency overload current level.
- **PERCENT DIFFERENTIAL SLOPE 2:** Enter the slope 2 percentage (of differential current to restraint current) for the dual-slope percent differential element. This setting is applicable for restraint currents above the kneepoint and is set to ensure stability under heavy through fault conditions which could lead to high differential currents as a result of CT saturation.



Since $I_{restraint} = \max(|I_1|, |I_2|, |I_3|)$, the differential current is not always greater than 100% of the restraint current. Because of this enhancement, the **PERCENT DIFFERENTIAL SLOPE 2** setting may cause slow operation (in rare cases no operation) in the following situations:

1. **PERCENT DIFFERENTIAL SLOPE 2** is set above 100%.
2. The source is connected to one winding only.

Therefore, the **PERCENT DIFFERENTIAL SLOPE 2** value cannot be greater than 100%. To increase dependability, the Slope 2 settings should be less than 98%

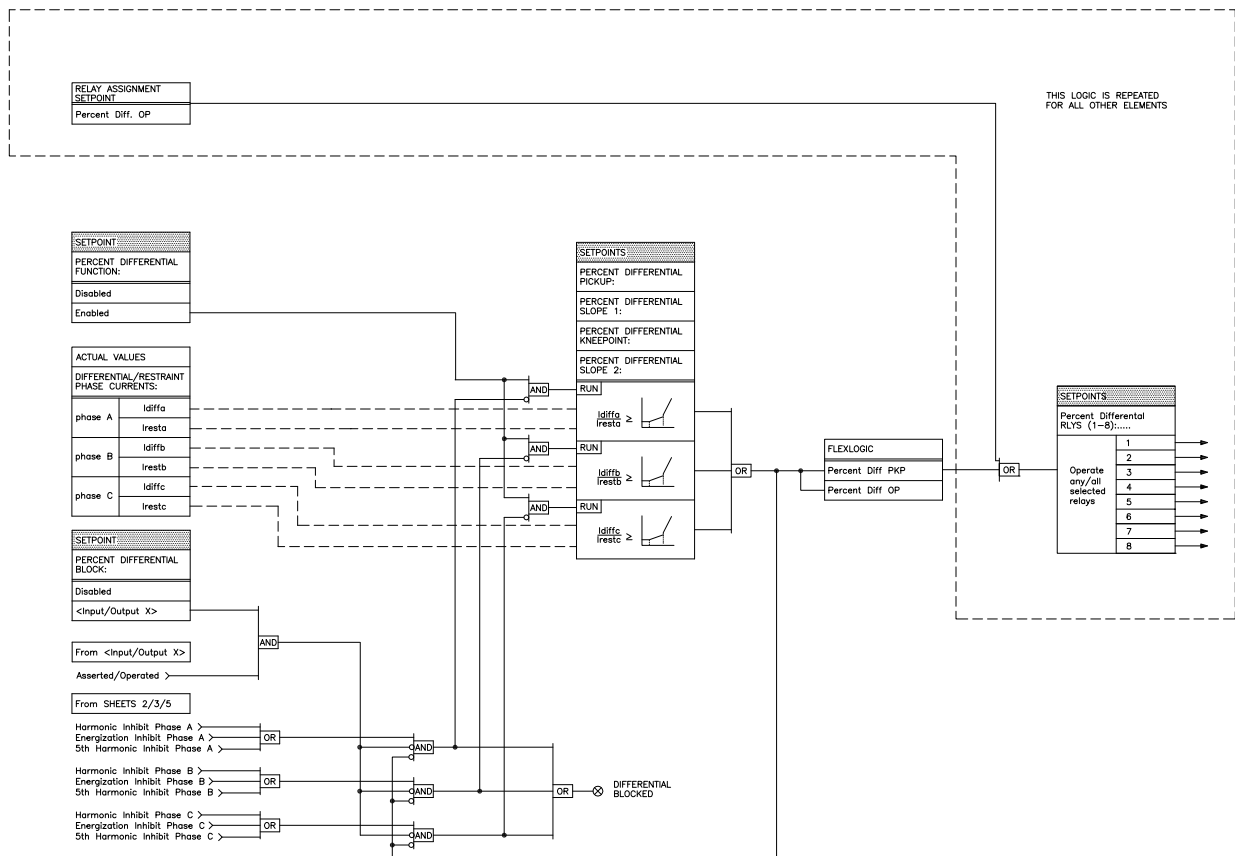
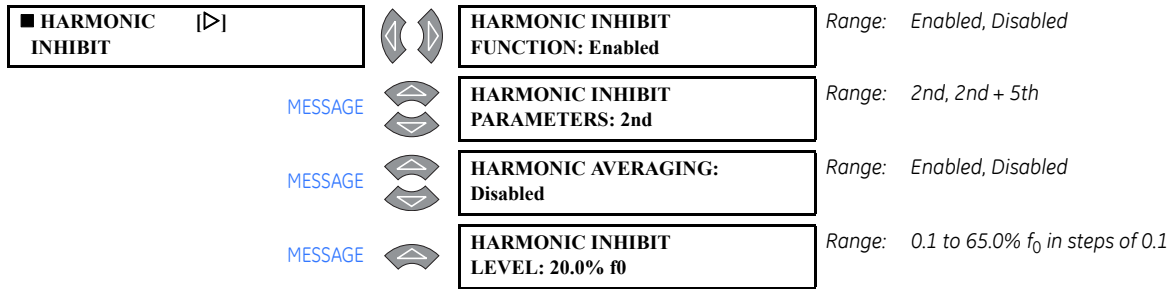

FIGURE 5-9: Percent differential scheme logic

5.6.3.3 Harmonic inhibit

PATH: SETPOINTS > S4 ELEMENTS > DIFFERENTIAL > HARMONIC INHIBIT



This menu contains the percent differential harmonic inhibit settings. This is the percent differential element in a particular phase if the 2nd harmonic of the same phase exceeds the **HARMONIC INHIBIT LEVEL** setpoint. With harmonic inhibit parameters set to “2nd + 5th”, the RMS sum of the 2nd and 5th harmonic components is compared against the level setting. With harmonic averaging enabled, all three phases are inhibited if the 3-phase average of the harmonics exceeds the level setting

- HARMONIC INHIBIT PARAMETERS:** Select “2nd” to compare only the 2nd harmonic current against the **HARMONIC INHIBIT LEVEL**. Select “2nd + 5th” to use the RMS sum of the 2nd and 5th harmonic components. For most transformers, the 2nd harmonic current alone will exceed 20% during energization and the “2nd” value is sufficient to inhibit the differential element for inrush current.
- HARMONIC AVERAGING:** Select “Enabled” to use the three-phase average of the harmonic current against the harmonic inhibit setting. For most applications, enabling harmonic averaging is not recommended.
- HARMONIC INHIBIT LEVEL:** Enter the level of harmonic current (2nd or 2nd+5th) above which the percent differential element will be inhibited from operating. For most applications, this level should be set to “20%”.

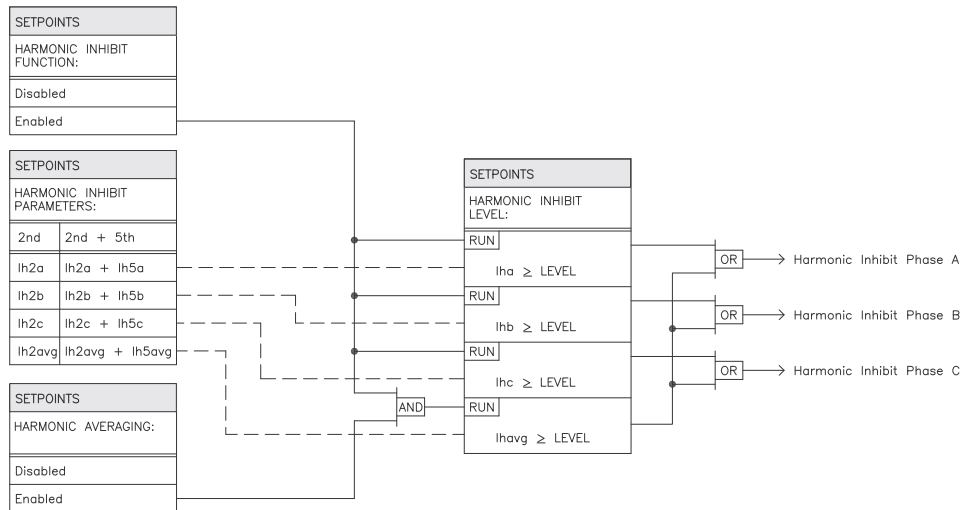

FIGURE 5-10: Harmonic inhibit scheme logic

5.6.3.4 Energization inhibit

PATH: SETPOINTS ▷ S4 ELEMENTS ▷ DIFFERENTIAL ▷ ENERGIZATION INHIBIT

■ ENERGIZATION INHIBIT		ENERGIZATION INHIBIT FUNCTION: Enabled	Range: Enabled, Disabled
MESSAGE		ENERGIZATION INHIBIT PARAMETERS: 2nd	Range: 2nd, 2nd + 5th
MESSAGE		HARMONIC AVERAGING: Enabled	Range: Enabled, Disabled
MESSAGE		ENERGIZATION INHIBIT LEVEL: 20.0% f ₀	Range: 0.1 to 65.0% f ₀ in steps of 0.1
MESSAGE		ENERGIZATION INHIBIT DURATION: 0.10 s	Range: 0.05 to 600.00 s in steps of 0.01
MESSAGE		ENERGIZATION SENSING BY CURRENT: Enabled	Range: Enabled, Disabled
MESSAGE		MINIMUM ENERGIZATION CURRENT: 0.10 x CT	Range: 0.10 to 0.50 x CT in steps of 0.01
MESSAGE		ENERGIZATION SENSING BY VOLTAGE: Disabled	Range: Enabled, Disabled. Seen only if Voltage Sensing is enabled.
MESSAGE		MINIMUM ENERGIZATION VOLTAGE: 0.85 x VT	Range: 0.50 to 0.99 x VT in steps of 0.01. Seen only if Voltage Sensing is enabled.
MESSAGE		BREAKERS ARE OPEN SIGNAL: Disabled	Range: Logic Input 1 to 16, Disabled
MESSAGE		PARALL XFMR BRKR CLS SIGNAL: Disabled	Range: Logic Input 1 to 16, Disabled

Over and above the standard harmonic inhibit feature programmed above, the 745 contains a harmonic inhibit feature which is in service only during energization and/or sympathetic inrush. De-energization and energization of the transformer is detected by any of the following three methods:

1. With energization sensing by current enabled, all currents dropping below the minimum energization current indicates de-energization; any current exceeding the minimum energization current indicates energization. This method is the least reliable method of detecting energization, since an energized and unloaded transformer will be detected as being de-energized if this method is used alone.
2. With energization sensing by voltage enabled, the voltage dropping below the minimum energization voltage indicates de-energization; any *current* exceeding the minimum energization current indicates energization.
3. With 'b' auxiliary contacts from all switching devices (which can be used to energize the transformer) connected in series to a logic input and assigned to the **BREAKERS ARE OPEN** setpoint, the contacts closed indicates de-energization; any current exceeding the minimum energization current indicates energization.

Energization inhibit settings are put in service upon detection of de-energization. Upon energization, the energization inhibit duration timer is initiated and the settings are removed from service when the time delay elapses. The energization inhibit feature may also be put in service during sympathetic inrush. The onset of sympathetic inrush is detected via a close command to the parallel transformer switching device connected to a

logic input, assigned to the **PARALL XFMR BRKR CLS** setpoint. Energization inhibit settings are put in service when the contact closes. Upon signal removal, the energization inhibit duration timer is initiated and the settings are removed from service when the time delay elapses.

In a breaker-and-a-half scheme, where current can be present in the CTs without being present in the transformer winding, it may be necessary to use the parallel transformer breaker close contact to initiate energization inhibit.

- **ENERGIZATION INHIBIT PARAMETERS:** Select “2nd” to compare the 2nd harmonic current against **HARMONIC INHIBIT LEVEL**. Select “2nd + 5th” to use the RMS sum of the 2nd and 5th harmonics.
- **HARMONIC AVERAGING:** Select “Enabled” to use the three-phase average of the harmonic current against the harmonic inhibit setting.
- **ENERGIZATION INHIBIT LEVEL:** Enter the level of harmonic current (2nd or 2nd + 5th) above which the percent differential element is inhibited from operating. This setting will often need to be set significantly lower than the **HARMONIC INHIBIT LEVEL**, especially when used with the “Parallel Xfmr BkrCls” logic input function for sympathetic inrush.
- **ENERGIZATION INHIBIT DURATION:** Enter the time delay from the moment of energization (or the end of the parallel breaker close command) before the energization inhibit feature is removed from service.
- **ENERGIZATION SENSING BY CURRENT:** Select “Enabled” to detect de-energization by the level of all currents dropping below the minimum energization current.
- **MINIMUM ENERGIZATION CURRENT:** Enter the current level below which the transformer is considered de-energized (energization sensing by current enabled), and above which the transformer is considered energized (any energization sensing enabled).
- **ENERGIZATION SENSING BY VOLTAGE:** Select “Enabled” to detect de-energization by the level of the voltage dropping below the minimum energization voltage. This setpoint is displayed only if **S2 SYSTEM SETUP ▷ VOLTAGE INPUT ▷ VOLTAGE SENSING** is “Enabled”.
- **MINIMUM ENERGIZATION VOLTAGE:** Enter the voltage level below which the transformer is considered de-energized (when **ENERGIZATION SENSING BY VOLTAGE** is “Enabled”). This setpoint is displayed only if **S2 SYSTEM SETUP ▷ VOLTAGE INPUT ▷ VOLTAGE SENSING** is “Enabled”.
- **BREAKERS ARE OPEN SIGNAL:** Select any logic input which, when asserted, indicates to the 745 that the transformer is de-energized. The selected logic input should be connected to the auxiliary contacts of the transformer breaker or disconnect switch.
- **PARALL XFMR BRKR CLS SIGNAL:** Select any logic input which, when asserted, will indicate to the 745 the onset of sympathetic inrush. The selected logic input should be connected to the close command going to the parallel transformer switching device.

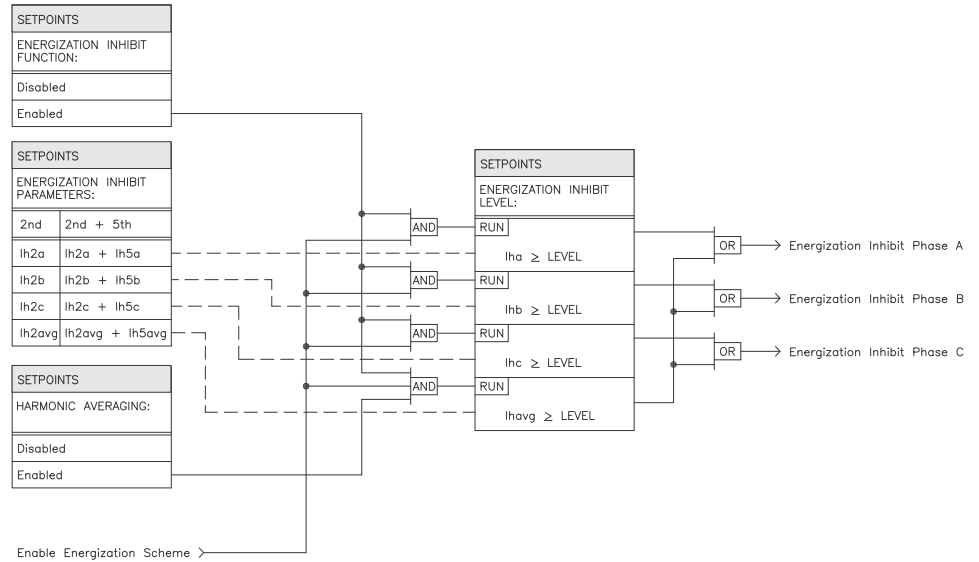

FIGURE 5-11: Energization inhibit scheme logic

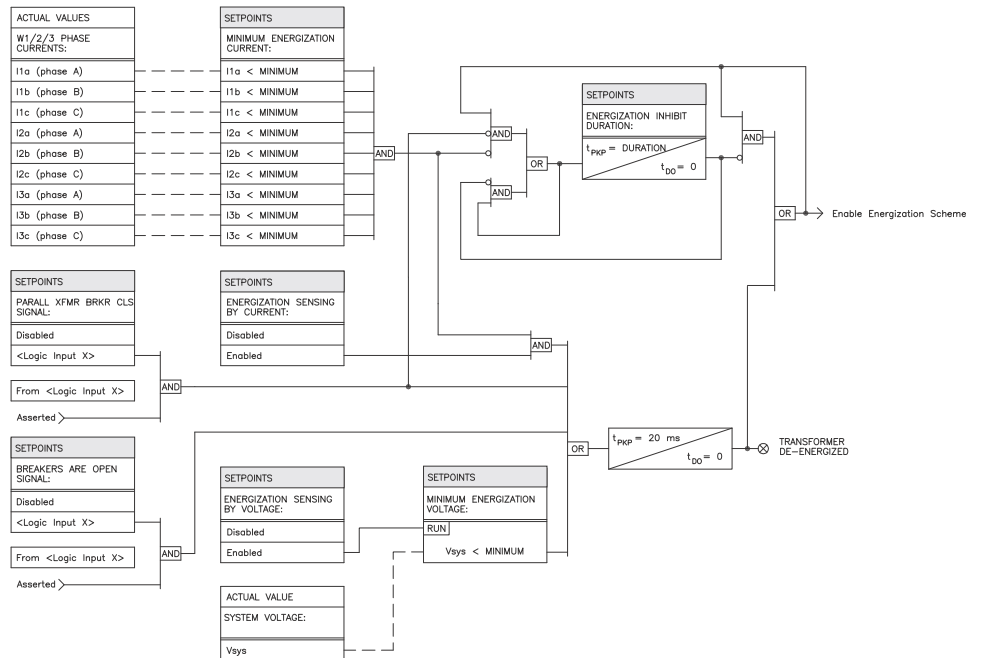

FIGURE 5-12: Energization sensing scheme logic

5.6.3.5 Fifth harmonic inhibit

PATH: SETPOINTS ▷ S4 ELEMENTS ▷ DIFFERENTIAL ▷ 5th HARM INHIBIT

5th HARM INHIBIT [▷]		5th HARMONIC INHIBIT FUNCTION: Enabled	Range: Enabled, Disabled
MESSAGE		HARMONIC AVERAGING: Disabled	Range: 0.10 to 0.50 × CT in steps of 0.01
MESSAGE		5th HARMONIC INHIBIT LEVEL: 10.0% fo	Range: 0.1 to 65.0% f ₀ in steps of 0.1

The 5th harmonic inhibit feature of the percent differential element allows inhibiting the percent differential during intentional overexcitation of the system. This feature inhibits the percent differential element in a particular phase if the 5th harmonic of the same phase exceeds the harmonic inhibit level setting. With harmonic averaging enabled, all three phases are inhibited if the three-phase average of the 5th harmonic exceeds the level setting.

- **HARMONIC AVERAGING:** Select “Enabled” to use the three-phase average of the 5th harmonic current against the harmonic inhibit setting.
- **5th HARMONIC INHIBIT LEVEL:** Enter the level of 5th harmonic current above which the percent differential element will be inhibited from operating.

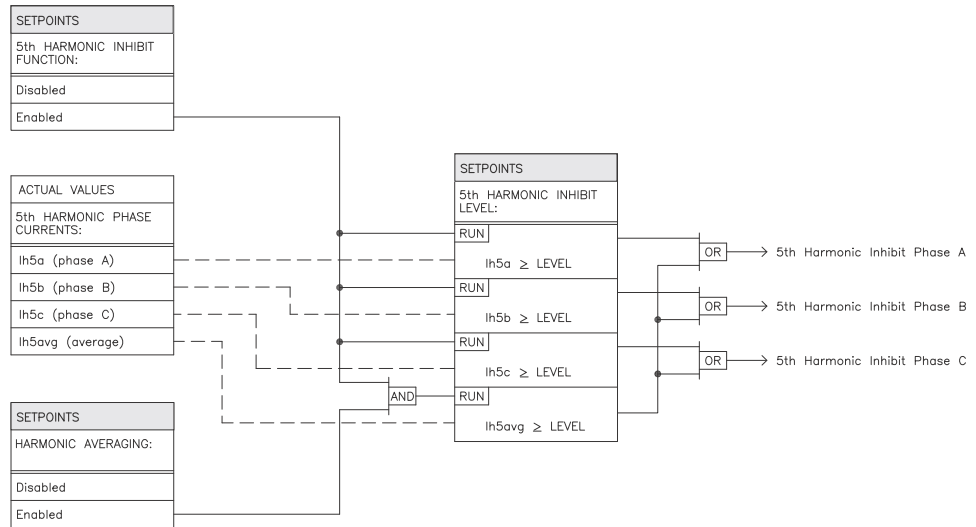

FIGURE 5–13: 5th harmonic inhibit scheme logic

5.6.4 Instantaneous Differential

PATH: SETPOINTS ▾ ▾ S4 ELEMENTS ▾ ▾ INST DIFFERENTIAL

<div style="border: 1px solid black; padding: 2px;"> ■ INST DIFFERENTIAL </div>		<div style="border: 1px solid black; padding: 2px;"> INST DIFFERENTIAL FUNCTION: Enabled </div>	<i>Range: Enabled, Disabled</i>
MESSAGE		<div style="border: 1px solid black; padding: 2px;"> INST DIFFERENTIAL RLYS (1-8): ----- </div>	<i>Range: 1 to 8</i>
MESSAGE		<div style="border: 1px solid black; padding: 2px;"> INST DIFFERENTIAL TARGET: Latched </div>	<i>Range: Self-Reset, Latched, None</i>
MESSAGE		<div style="border: 1px solid black; padding: 2px;"> INST DIFFERENTIAL PICKUP: 8.00 x CT </div>	<i>Range: 3.00 to 20.00 x CT in steps of 0.01</i>
MESSAGE		<div style="border: 1px solid black; padding: 2px;"> INST DIFFERENTIAL BLOCK: Disabled </div>	<i>Range: Logc Inpt 1 to 16, Virt Inpt 1 to 16, Output Rly 2 to 8, SelfTest Rly, Vir Outpt 1 to 5, Disabled</i>

This section contains the settings to configure the (unrestrained) instantaneous differential element, for protection under high magnitude internal faults.

- INST DIFFERENTIAL PICKUP:** Enter the level of differential current (in units of relay nominal current) above which the instantaneous differential element will pickup and operate.

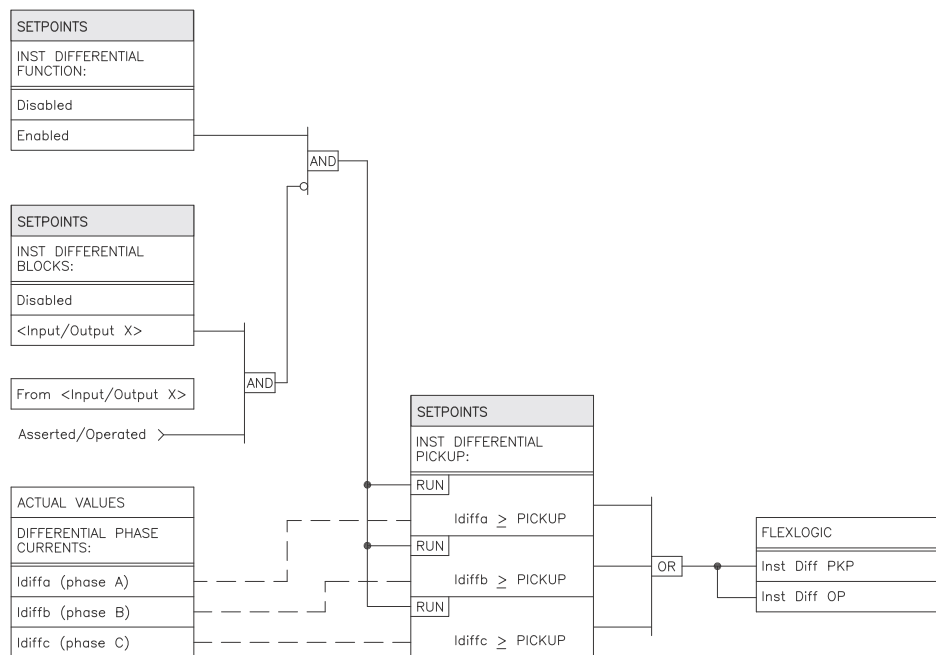

FIGURE 5-14: Instantaneous differential scheme logic

5.6.5 Phase Overcurrent

5.6.5.1 Main menu

PATH: SETPOINTS ▾ ▾ S4 ELEMENTS ▾ ▾ PHASE OC

■ PHASE OC ▷		■ W1 PHASE TIME OC ▷	See page 5-63
MESSAGE		■ W2 PHASE TIME OC ▷	See page 5-63
MESSAGE		■ W3 PHASE TIME OC ▷	See page 5-63
MESSAGE		■ W1 PHASE INST OC 1 ▷	See page 5-65
MESSAGE		■ W2 PHASE INST OC 1 ▷	See page 5-65
MESSAGE		■ W3 PHASE INST OC 1 ▷	See page 5-65
MESSAGE		■ W1 PHASE INST OC 2 ▷	See page 5-65
MESSAGE		■ W2 PHASE INST OC 2 ▷	See page 5-65
MESSAGE		■ W3 PHASE INST OC 2 ▷	See page 5-65

This section contains settings to configure the phase overcurrent elements. Included are phase time overcurrents and two levels of phase instantaneous overcurrent for each phase of each winding.

5.6.5.2 Time Overcurrent Curves

The inverse time overcurrent curves used by the time overcurrent elements are the ANSI, IEC, and GE type IAC curve shapes. This allows for simplified coordination with downstream devices. If however, none of these curve shapes is adequate, FlexCurves™ may be used to customize the inverse time curve characteristics. The Definite Time curve is also an option that may be appropriate if only simple protection is required.

The following overcurrent curve types are available:

- **ANSI curves:** ANSI extremely inverse, ANSI very inverse, ANSI normally inverse, and ANSI moderately inverse
- **IEC curves:** IEC curves A, B, and C (BS142); IEC short inverse
- **GE type IAC curves:** IAC extremely inverse, IAC very inverse, IAC inverse, and IAC short inverse
- **Other curves:** FlexCurves™ A, B, and C; definite time curve

A time dial multiplier setting allows selection of a multiple of the base curve shape (where the time dial multiplier = 1) with the curve shape (**SHAPE**) setting. Unlike the electromechanical time dial equivalent, operate times are directly proportional to the time multiplier (**TIME OC MULTIPLIER**) setting value. For example, all times for a multiplier of 10 are 10 times the multiplier 1 or base curve values. Setting the multiplier to zero results in an instantaneous response to all current levels above pickup.



Graphs of standard time-current curves on 11" × 17" log-log graph paper are available upon request from the GE Multilin literature department. The original files are also available in PDF from the GE Multilin website at <http://www.GEmultilin.com>.

FlexCurves™:

The custom FlexCurve™ is described in FlexCurves™ on page 5–38. The curve shapes for the FlexCurves™ are derived from the formula:

$$T = M \times \left[\text{FlexcurveTime at } \frac{I}{I_{pickup}} \right] \text{ when } \frac{I}{I_{pickup}} \geq 1.00 \tag{EQ 5.6}$$

where: T = operate time (in seconds)
 M = multiplier setting,
 I = input current, and
 I_{pickup} = pickup current setpoint

Definite time curve:

The definite time curve shape operates as soon as the pickup level is exceeded for a specified period of time. The base definite time curve delay is 0.1 seconds. The curve multiplier makes this delay adjustable from 0.000 (instantaneous) to 10.000 seconds.

ANSI curves:

The ANSI TOC shapes conform to industry standards and the ANSI C37.90 curve classifications for extremely, very, normally, and moderately inverse shapes. The ANSI curves are derived from the formula below, where $1.03 \leq I / I_{pickup} < 20.0$:

$$T = M \times \left[A + \frac{B}{I/I_{pickup} - C} + \frac{D}{(I/I_{pickup} - C)^2} + \frac{E}{(I/I_{pickup} - C)^3} \right] \tag{EQ 5.7}$$

where: T = operate time (in seconds), M = multiplier setpoint, I = input current
 I_{pickup} = pickup current setpoint, and A, B, C, D, E = constants

Table 5–4: ANSI curve constants

ANSI curve shape	A	B	C	D	E
ANSI extremely inverse	0.0399	0.2294	0.5000	3.0094	0.7222
ANSI very inverse	0.0615	0.7989	0.3400	-0.2840	4.0505
ANSI normally inverse	0.0274	2.2614	0.3000	-4.1899	9.1272
ANSI moderately inverse	0.1735	0.6791	0.8000	-0.0800	0.1271

Table 5–5: ANSI curve trip times (in seconds)

TDM	Current (I / I_{pickup})									
	1.5	2.0	3.0	4.0	5.0	6.0	7.0	8.0	9.0	10.0
ANSI Extremely Inverse										
0.5	2.000	0.872	0.330	0.184	0.124	0.093	0.075	0.063	0.055	0.049
1.0	4.001	1.744	0.659	0.368	0.247	0.185	0.149	0.126	0.110	0.098
2.0	8.002	3.489	1.319	0.736	0.495	0.371	0.298	0.251	0.219	0.196
4.0	16.004	6.977	2.638	1.472	0.990	0.742	0.596	0.503	0.439	0.393
6.0	24.005	10.466	3.956	2.208	1.484	1.113	0.894	0.754	0.658	0.589
8.0	32.007	13.955	5.275	2.944	1.979	1.483	1.192	1.006	0.878	0.786
10.0	40.009	17.443	6.594	3.680	2.474	1.854	1.491	1.257	1.097	0.982
ANSI Very Inverse										
0.5	1.567	0.663	0.268	0.171	0.130	0.108	0.094	0.085	0.078	0.073
1.0	3.134	1.325	0.537	0.341	0.260	0.216	0.189	0.170	0.156	0.146
2.0	6.268	2.650	1.074	0.682	0.520	0.432	0.378	0.340	0.312	0.291

Table 5-5: ANSI curve trip times (in seconds)

TDM	Current (I / I_{pickup})									
	1.5	2.0	3.0	4.0	5.0	6.0	7.0	8.0	9.0	10.0
4.0	12.537	5.301	2.148	1.365	1.040	0.864	0.755	0.680	0.625	0.583
6.0	18.805	7.951	3.221	2.047	1.559	1.297	1.133	1.020	0.937	0.874
8.0	25.073	10.602	4.295	2.730	2.079	1.729	1.510	1.360	1.250	1.165
10.0	31.341	13.252	5.369	3.412	2.599	2.161	1.888	1.700	1.562	1.457
ANSI Normally Inverse										
0.5	2.142	0.883	0.377	0.256	0.203	0.172	0.151	0.135	0.123	0.113
1.0	4.284	1.766	0.754	0.513	0.407	0.344	0.302	0.270	0.246	0.226
2.0	8.568	3.531	1.508	1.025	0.814	0.689	0.604	0.541	0.492	0.452
4.0	17.137	7.062	3.016	2.051	1.627	1.378	1.208	1.082	0.983	0.904
6.0	25.705	10.594	4.524	3.076	2.441	2.067	1.812	1.622	1.475	1.356
8.0	34.274	14.125	6.031	4.102	3.254	2.756	2.415	2.163	1.967	1.808
10.0	42.842	17.656	7.539	5.127	4.068	3.445	3.019	2.704	2.458	2.260
ANSI Moderately Inverse										
0.5	0.675	0.379	0.239	0.191	0.166	0.151	0.141	0.133	0.128	0.123
1.0	1.351	0.757	0.478	0.382	0.332	0.302	0.281	0.267	0.255	0.247
2.0	2.702	1.515	0.955	0.764	0.665	0.604	0.563	0.533	0.511	0.493
4.0	5.404	3.030	1.910	1.527	1.329	1.208	1.126	1.066	1.021	0.986
6.0	8.106	4.544	2.866	2.291	1.994	1.812	1.689	1.600	1.532	1.479
8.0	10.807	6.059	3.821	3.054	2.659	2.416	2.252	2.133	2.043	1.972
10.0	13.509	7.574	4.776	3.818	3.324	3.020	2.815	2.666	2.554	2.465

IEC curves:

For European applications, the relay offers the four standard curves defined in IEC 255-4 and British standard BS142. These are defined as IEC Curve A, IEC Curve B, IEC Curve C, and Short Inverse. The formulae for these curves are:

$$T = M \times \left(\frac{K}{(I/I_{pickup})^E - 1} \right) \quad \text{(EQ 5.8)}$$

where: T = trip time (in seconds), M = multiplier setpoint, I = input current, I_{pickup} = pickup current setpoint, and K , E = constants.

Table 5-6: IEC (BS) inverse time curve constants

IEC (BS) curve shape	K	E
IEC curve A (BS142)	0.140	0.020
IEC curve B (BS142)	13.500	1.000
IEC curve C (BS142)	80.000	2.000
IEC short inverse	0.050	0.040

Table 5-7: IEC curve trip times (in seconds)

TDM	Current (I / I_{pickup})									
	1.5	2.0	3.0	4.0	5.0	6.0	7.0	8.0	9.0	10.0
IEC curve A										
0.05	0.860	0.501	0.315	0.249	0.214	0.192	0.176	0.165	0.156	0.149
0.10	1.719	1.003	0.630	0.498	0.428	0.384	0.353	0.330	0.312	0.297
0.20	3.439	2.006	1.260	0.996	0.856	0.767	0.706	0.659	0.623	0.594
0.40	6.878	4.012	2.521	1.992	1.712	1.535	1.411	1.319	1.247	1.188
0.60	10.317	6.017	3.781	2.988	2.568	2.302	2.117	1.978	1.870	1.782
0.80	13.755	8.023	5.042	3.984	3.424	3.070	2.822	2.637	2.493	2.376
1.00	17.194	10.029	6.302	4.980	4.280	3.837	3.528	3.297	3.116	2.971

Table 5-7: IEC curve trip times (in seconds)

TDM	Current (I / I_{pickup})									
	1.5	2.0	3.0	4.0	5.0	6.0	7.0	8.0	9.0	10.0
IEC curve B										
0.05	1.350	0.675	0.338	0.225	0.169	0.135	0.113	0.096	0.084	0.075
0.10	2.700	1.350	0.675	0.450	0.338	0.270	0.225	0.193	0.169	0.150
0.20	5.400	2.700	1.350	0.900	0.675	0.540	0.450	0.386	0.338	0.300
0.40	10.800	5.400	2.700	1.800	1.350	1.080	0.900	0.771	0.675	0.600
0.60	16.200	8.100	4.050	2.700	2.025	1.620	1.350	1.157	1.013	0.900
0.80	21.600	10.800	5.400	3.600	2.700	2.160	1.800	1.543	1.350	1.200
1.00	27.000	13.500	6.750	4.500	3.375	2.700	2.250	1.929	1.688	1.500
IEC curve C										
0.05	3.200	1.333	0.500	0.267	0.167	0.114	0.083	0.063	0.050	0.040
0.10	6.400	2.667	1.000	0.533	0.333	0.229	0.167	0.127	0.100	0.081
0.20	12.800	5.333	2.000	1.067	0.667	0.457	0.333	0.254	0.200	0.162
0.40	25.600	10.667	4.000	2.133	1.333	0.914	0.667	0.508	0.400	0.323
0.60	38.400	16.000	6.000	3.200	2.000	1.371	1.000	0.762	0.600	0.485
0.80	51.200	21.333	8.000	4.267	2.667	1.829	1.333	1.016	0.800	0.646
1.00	64.000	26.667	10.000	5.333	3.333	2.286	1.667	1.270	1.000	0.808
IEC short time										
0.05	0.153	0.089	0.056	0.044	0.038	0.034	0.031	0.029	0.027	0.026
0.10	0.306	0.178	0.111	0.088	0.075	0.067	0.062	0.058	0.054	0.052
0.20	0.612	0.356	0.223	0.175	0.150	0.135	0.124	0.115	0.109	0.104
0.40	1.223	0.711	0.445	0.351	0.301	0.269	0.247	0.231	0.218	0.207
0.60	1.835	1.067	0.668	0.526	0.451	0.404	0.371	0.346	0.327	0.311
0.80	2.446	1.423	0.890	0.702	0.602	0.538	0.494	0.461	0.435	0.415
1.00	3.058	1.778	1.113	0.877	0.752	0.673	0.618	0.576	0.544	0.518

IAC curves:

The curves for the General Electric type IAC relay family are derived from the formulae:

$$T = M \times \left(A + \frac{B}{(I/I_{pu}) - C} + \frac{D}{((I/I_{pu}) - C)^2} + \frac{E}{((I/I_{pu}) - C)^3} \right) \tag{EQ 5.9}$$

where: T = trip time (in seconds), M = multiplier setpoint, I = input current, I_{pickup} = pickup current setpoint, and A to E are constants.

Table 5-8: GE type IAC inverse curve constants

IAC curve shape	A	B	C	D	E
IAC extreme inverse	0.0040	0.6379	0.6200	1.7872	0.2461
IAC very inverse	0.0900	0.7955	0.1000	-1.2885	7.9586
IAC inverse	0.2078	0.8630	0.8000	-0.4180	0.1947
IAC short inverse	0.0428	0.0609	0.6200	-0.0010	0.0221

Table 5-9: IAC curve trip times

TDM	Current (I / I_{pickup})									
	1.5	2.0	3.0	4.0	5.0	6.0	7.0	8.0	9.0	10.0
IAC extremely inverse										
0.5	1.699	0.749	0.303	0.178	0.123	0.093	0.074	0.062	0.053	0.046
1.0	3.398	1.498	0.606	0.356	0.246	0.186	0.149	0.124	0.106	0.093
2.0	6.796	2.997	1.212	0.711	0.491	0.372	0.298	0.248	0.212	0.185
4.0	13.591	5.993	2.423	1.422	0.983	0.744	0.595	0.495	0.424	0.370

Table 5-9: IAC curve trip times

TDM	Current (I / I_{pickup})									
	1.5	2.0	3.0	4.0	5.0	6.0	7.0	8.0	9.0	10.0
6.0	20.387	8.990	3.635	2.133	1.474	1.115	0.893	0.743	0.636	0.556
8.0	27.183	11.987	4.846	2.844	1.966	1.487	1.191	0.991	0.848	0.741
10.0	33.979	14.983	6.058	3.555	2.457	1.859	1.488	1.239	1.060	0.926
IAC very inverse										
0.5	1.451	0.656	0.269	0.172	0.133	0.113	0.101	0.093	0.087	0.083
1.0	2.901	1.312	0.537	0.343	0.266	0.227	0.202	0.186	0.174	0.165
2.0	5.802	2.624	1.075	0.687	0.533	0.453	0.405	0.372	0.349	0.331
4.0	11.605	5.248	2.150	1.374	1.065	0.906	0.810	0.745	0.698	0.662
6.0	17.407	7.872	3.225	2.061	1.598	1.359	1.215	1.117	1.046	0.992
8.0	23.209	10.497	4.299	2.747	2.131	1.813	1.620	1.490	1.395	1.323
10.0	29.012	13.121	5.374	3.434	2.663	2.266	2.025	1.862	1.744	1.654
IAC inverse										
0.5	0.578	0.375	0.266	0.221	0.196	0.180	0.168	0.160	0.154	0.148
1.0	1.155	0.749	0.532	0.443	0.392	0.360	0.337	0.320	0.307	0.297
2.0	2.310	1.499	1.064	0.885	0.784	0.719	0.674	0.640	0.614	0.594
4.0	4.621	2.997	2.128	1.770	1.569	1.439	1.348	1.280	1.229	1.188
6.0	6.931	4.496	3.192	2.656	2.353	2.158	2.022	1.921	1.843	1.781
8.0	9.242	5.995	4.256	3.541	3.138	2.878	2.695	2.561	2.457	2.375
10.0	11.552	7.494	5.320	4.426	3.922	3.597	3.369	3.201	3.072	2.969
IAC short inverse										
0.5	0.072	0.047	0.035	0.031	0.028	0.027	0.026	0.026	0.025	0.025
1.0	0.143	0.095	0.070	0.061	0.057	0.054	0.052	0.051	0.050	0.049
2.0	0.286	0.190	0.140	0.123	0.114	0.108	0.105	0.102	0.100	0.099
4.0	0.573	0.379	0.279	0.245	0.228	0.217	0.210	0.204	0.200	0.197
6.0	0.859	0.569	0.419	0.368	0.341	0.325	0.314	0.307	0.301	0.296
8.0	1.145	0.759	0.559	0.490	0.455	0.434	0.419	0.409	0.401	0.394
10.0	1.431	0.948	0.699	0.613	0.569	0.542	0.524	0.511	0.501	0.493

5.6.5.3 Winding 1(3) Phase Time Overcurrent

PATH: SETPOINTS ▾ ▾ S4 ELEMENTS ▾ ▾ PHASE OC ▾ w1(3) PHASE TIME OC

■ W1 PHASE TIME OC		W1 PHASE TIME OC FUNCTION: Enabled	Range: Enabled, Disabled
MESSAGE		W1 PHASE TIME OC RLYS (1-8): -----	Range: 1 to 8
MESSAGE		W1 PHASE TIME OC TARGET: Latched	Range: Self-Reset, Latched, None
MESSAGE		W1 PHASE TIME OC PICKUP: 1.20 x CT	Range: 0.05 to 20.00 x CT in steps of 0.01
MESSAGE		W1 PHASE TIME OC SHAPE: Ext Inverse	Range: see description below
MESSAGE		W1 PHASE TIME OC MULTIPLIER: 1.00	Range: 0.00 to 100.00 in steps of 0.01
MESSAGE		W1 PHASE TIME OC RESET: Linear	Range: Instantaneous, Linear
MESSAGE		W1 PHASE TIME OC BLOCK: Disabled	Range: Logic Inpt 1 to 16, Virt Inpt 1 to 16, Output Rly 2 to 8, SelfTest Rly, Vir Outpt 1 to 5, Disabled
MESSAGE		W1 HARMONIC DERATING CORRECTION: Disabled	Range: Logic Input 1 to 16, Disabled

- **W1(3) PHASE TIME OC PICKUP:** Enter the phase current level (in units of relay nominal current) above which the winding 1(3) phase time overcurrent element will pickup and start timing.
- **W1(3) PHASE TIME OC SHAPE:** Select the time overcurrent curve shape to use for the winding 1(3) phase time overcurrent. *Time Overcurrent Curves* on page 5–58 describes the time overcurrent curve shapes.
- **W1(3) PHASE TIME OC MULTIPLIER:** Enter the multiplier constant by which the selected time overcurrent curve shape (the base curve) is to be shifted in time.
- **W1(3) PHASE TIME OC RESET:** Select “Linear” reset to coordinate with electromechanical time overcurrent relays, in which the reset characteristic (when the current falls below the reset threshold before tripping) is proportional to ratio of energy accumulated to that required to trip. Select “Instantaneous” reset to coordinate with relays, such as most static units, with instantaneous reset characteristics.
- **W1(3) HARMONIC DERATING CORRECTION:** Select “Enabled” to enable automatic harmonic derating correction of the winding 1(3) phase time overcurrent curve. The 745 calculates the derated transformer capability when supplying non-sinusoidal load currents (as per ANSI / IEEE C57.110-1986) and, when this feature is enabled, automatically shifts the phase time overcurrent curve pickup in order to maintain the required protection margin with respect to the transformer thermal damage curve, as illustrated below.

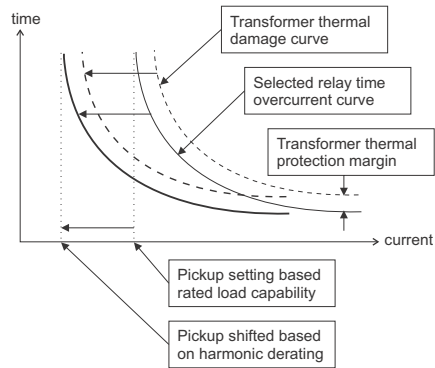

FIGURE 5-15: Harmonic derating correction

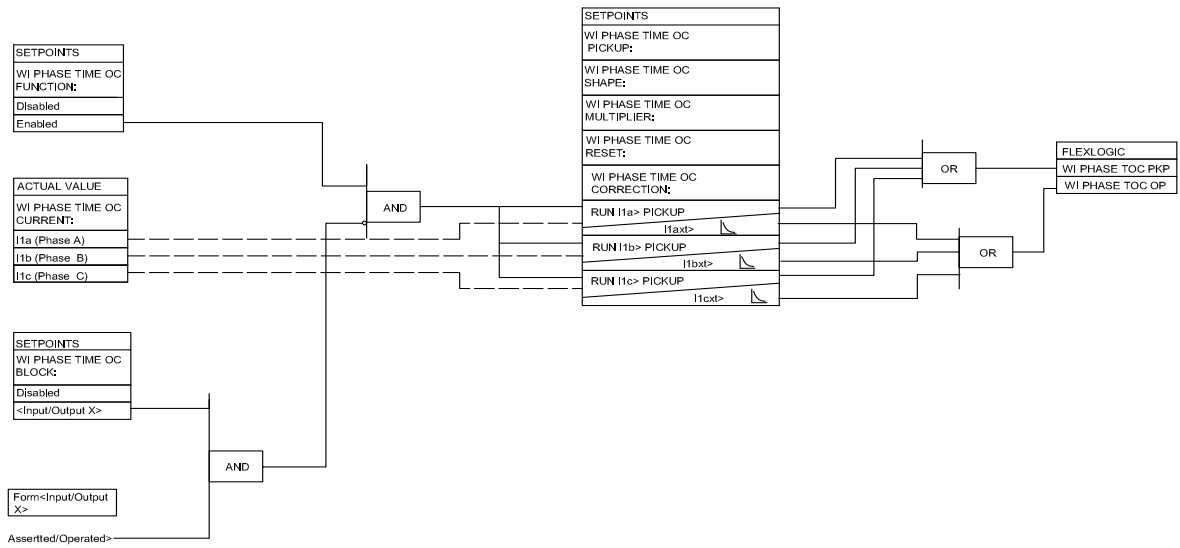

FIGURE 5-16: Phase time overcurrent scheme logic

5.6.5.4 Winding 1 to 3 Phase Instantaneous Overcurrent

PATH: SETPOINTS ▾ ▾ S4 ELEMENTS ▾ ▾ PHASE OC ▾ ▾ W1(3) PHASE INST OC 1(2)

<div style="border: 1px solid black; padding: 2px;"> <p>■ W1 PHASE INST OC 1</p> </div>		<div style="border: 1px solid black; padding: 2px;"> <p>W1 PHASE INST OC 1 FUNCTION: Enabled</p> </div>	<p>Range: Enabled, Disabled</p>
MESSAGE		<div style="border: 1px solid black; padding: 2px;"> <p>W1 PHASE INST OC 1 RLYS (1-8): -----</p> </div>	<p>Range: 1 to 8</p>
MESSAGE		<div style="border: 1px solid black; padding: 2px;"> <p>W1 PHASE INST OC 1 TARGET: Latched</p> </div>	<p>Range: Self-Reset, Latched, None</p>
MESSAGE		<div style="border: 1px solid black; padding: 2px;"> <p>W1 PHASE INST OC 1 PICKUP: 10.00 x CT</p> </div>	<p>Range: 0.05 to 20.00 x CT in steps of 0.01</p>
MESSAGE		<div style="border: 1px solid black; padding: 2px;"> <p>W1 PHASE INST OC 1 DELAY: 0 ms</p> </div>	<p>Range: 0 to 60000 ms in steps of 1</p>
MESSAGE		<div style="border: 1px solid black; padding: 2px;"> <p>W1 PHASE INST OC 1 BLOCK: Disabled</p> </div>	<p>Range: Logc Inpt 1 to 16, Virt Inpt 1 to 16, Output Rly 2 to 8, SelfTest Rly, Vir Outpt 1 to 5, Disabled</p>

- W1(3) PHASE INST OC 1(2) PICKUP:** Enter the level of phase current (in units of relay nominal current) above which the winding 1(3) phase instantaneous overcurrent 1 element will pickup and start the delay timer.
- W1(3) PHASE INST OC 1(2) DELAY:** Enter the time that the phase current must remain above the pickup level before the element operates.



The setpoint messages above and the following logic diagram are identical for the phase instantaneous overcurrent 2 element.

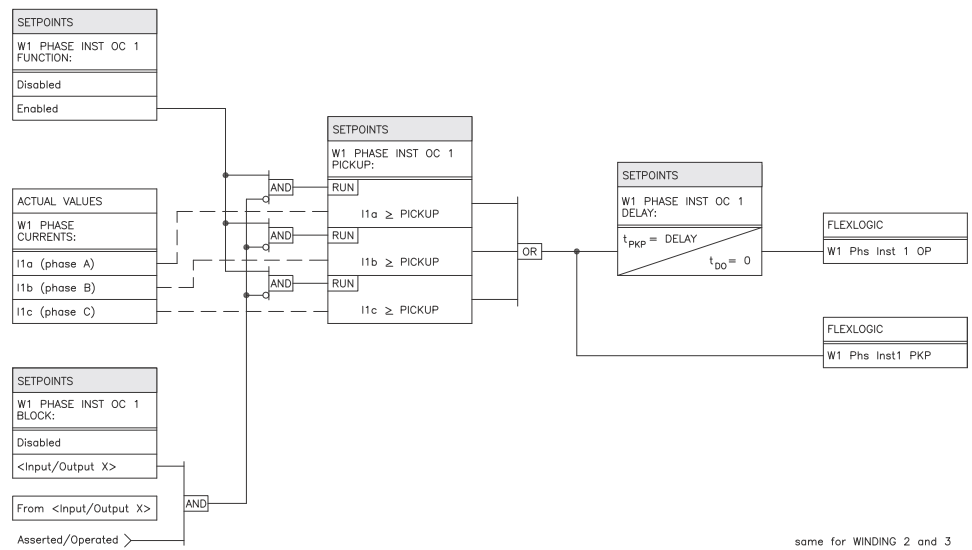

FIGURE 5-17: Phase instantaneous overcurrent 1 scheme logic

5.6.6 Neutral overcurrent

5.6.6.1 Main menu

PATH: SETPOINTS ▾ ▾ S4 ELEMENTS ▾ ▾ NEUTRAL OC

■ NEUTRAL OC ▷		■ W1 NTRL TIME OC ▷	See page 5-66
MESSAGE		■ W2 NTRL TIME OC ▷	See page 5-66
MESSAGE		■ W3 NTRL TIME OC ▷	See page 5-66
MESSAGE		■ W1 NTRL INST OC 1 ▷	See page 5-68
MESSAGE		■ W2 NTRL INST OC 1 ▷	See page 5-68
MESSAGE		■ W3 NTRL INST OC 1 ▷	See page 5-68
MESSAGE		■ W1 NTRL INST OC 2 ▷	See page 5-68
MESSAGE		■ W2 NTRL INST OC 2 ▷	See page 5-68
MESSAGE		■ W3 NTRL INST OC 2 ▷	See page 5-68

In the 745, “neutral” refers to residual current ($3I_0$), calculated internally as the vector sum of the three phases. The relay includes neutral time overcurrent and two levels of neutral instantaneous overcurrent for each winding.

5.6.6.2 Neutral Time Overcurrent

PATH: SETPOINTS ▾ ▾ S4 ELEMENTS ▾ ▾ NEUTRAL OC ▾ ▾ W1(3) NTRL TIME OC

■ W1 NTRL TIME OC ▷		W1 NEUTRAL TIME OC FUNCTION: Enabled	Range: Enabled, Disabled
MESSAGE		W1 NEUTRAL TIME OC RLYS (1-8): -----	Range: 1 to 8
MESSAGE		W1 NEUTRAL TIME OC TARGET: Latched	Range: Self-Reset, Latched, None
MESSAGE		W1 NEUTRAL TIME OC PICKUP: 0.85 x CT	Range: 0.05 to 20.00 x CT in steps of 0.01
MESSAGE		W1 NEUTRAL TIME OC SHAPE: Ext Inverse	Range: see description below
MESSAGE		W1 NEUTRAL TIME OC MULTIPLIER: 1.00	Range: 0.00 to 100.00 in steps of 0.01
MESSAGE		W1 NEUTRAL TIME OC RESET: Linear	Range: Instantaneous, Linear
MESSAGE		W1 NEUTRAL TIME OC BLOCK: Disabled	Range: Logic Inpt 1 to 16, Virt Inpt 1 to 16, Output Rly 2 to 8, SelfTest Rly, Vir Output 1 to 5, Disabled

- **W1(3) NEUTRAL TIME OC PICKUP:** Enter the level of neutral current (in units of relay nominal current) above which the winding 1(3) neutral time overcurrent element will pickup and start timing.
- **W1(3) NEUTRAL TIME OC SHAPE:** Select the time overcurrent curve shape to be used for the winding 1(3) neutral time overcurrent element. The *Time Overcurrent Curves* on page 5–58 describe the time overcurrent curve shapes.
- **W1(3) NEUTRAL TIME OC MULTIPLIER:** Enter the multiplier constant by which the selected time overcurrent curve shape (the base curve) is to be shifted in time.
- **W1(3) NEUTRAL TIME OC RESET:** Select “Linear” reset to coordinate with electromechanical time overcurrent relays, in which the reset characteristic (when the current falls below the reset threshold before tripping) is proportional to ratio of energy accumulated to that required to trip. Select “Instantaneous” reset to coordinate with relays, such as most static units, with instantaneous reset characteristics.

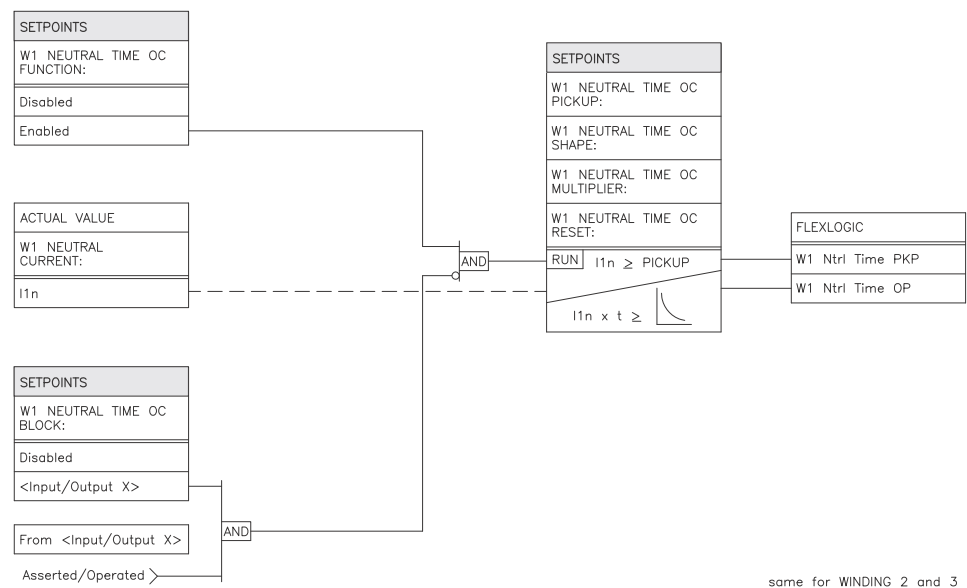

FIGURE 5–18: Neutral time overcurrent scheme logic

5.6.6.3 Neutral Instantaneous Overcurrent

PATH: SETPOINTS ▾ ▾ S4 ELEMENTS ▾ ▾ NEUTRAL OC ▾ ▾ W1(3) NTRL INST OC 1(2)

■ W1 NTRL INST OC 1	▶	W1 NEUTRAL INST OC 1 FUNCTION: Enabled	Range: Enabled, Disabled
MESSAGE	▶	W1 NEUTRAL INST OC 1 RLYS (1-8): -----	Range: 1 to 8
MESSAGE	▶	W1 NEUTRAL INST OC 1 TARGET: Latched	Range: Self-Reset, Latched, None
MESSAGE	▶	W1 NEUTRAL INST OC 1 PICKUP: 10.00 x CT	Range: 0.05 to 20.00 x CT in steps of 0.01
MESSAGE	▶	W1 NEUTRAL INST OC 1 DELAY: 0 ms	Range: 0 to 60000 ms in steps of 1
MESSAGE	▶	W1 NEUTRAL INST OC 1 BLOCK: Disabled	Range: Logc Inpt 1 to 16, Virt Inpt 1 to 16, Output Rly 2 to 8, SelfTest Rly, Vir Outpt 1 to 5, Disabled

- **W1(3) NEUTRAL INST OC 1(2) PICKUP:** Enter the level of neutral current (in units of relay nominal current) above which the winding 1(3) neutral instantaneous overcurrent 1 element will pickup and start the delay timer.
- **W1(3) NEUTRAL INST OC 1(2) DELAY:** Enter the time that the neutral current must remain above the pickup level before the element operates.



The setpoint messages above and the following logic diagram are identical for the neutral instantaneous overcurrent 2 element.

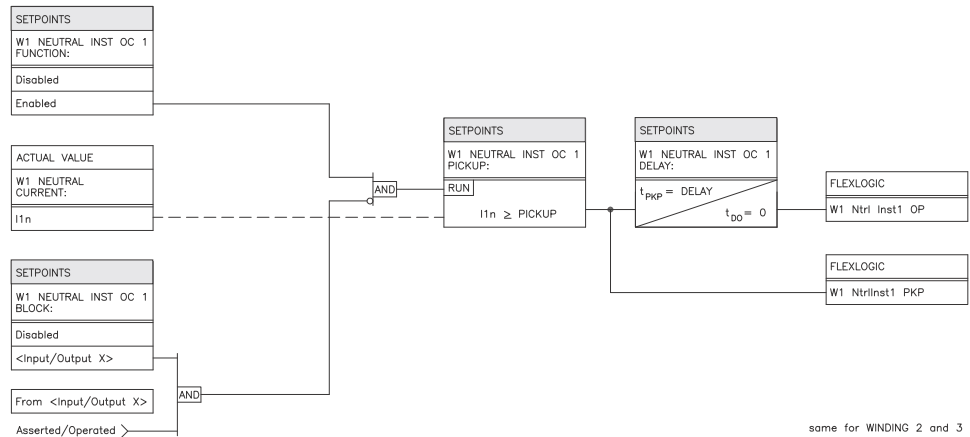











FIGURE 5-19: Neutral instantaneous overcurrent scheme logic

5.6.7 Ground Overcurrent

5.6.7.1 Main Menu

PATH: SETPOINTS ▾ ▾ S4 ELEMENTS ▾ ▾ GROUND OC









■ GROUND OC ▷		■ W1 GND TIME OC ▷	See page 5-70
MESSAGE		■ W2 GND TIME OC ▷	See page 5-70
MESSAGE		■ W3 GND TIME OC ▷	See page 5-70
MESSAGE		■ W1 GND INST OC 1 ▷	See page 5-71
MESSAGE		■ W2 GND INST OC 1 ▷	See page 5-71
MESSAGE		■ W3 GND INST OC 1 ▷	See page 5-71
MESSAGE		■ W1 GND INST OC 2 ▷	See page 5-71
MESSAGE		■ W2 GND INST OC 2 ▷	See page 5-71
MESSAGE		■ W3 GND INST OC 2 ▷	See page 5-71

In the 745, “ground” refers to the current measured in a CT in the connection between the transformer neutral and ground. The 745 has two ground inputs which could be assigned to any of the three windings, based on the transformer type selected with respect to the rules in table 3-2.

As the ground overcurrent settings corresponding to the winding-assigned ground inputs, are displayed and enabled. This section contains the settings to configure the ground overcurrent elements. Included are ground time overcurrents for each associated winding, and two levels of ground instantaneous overcurrent for each associated winding.

5.6.7.2 Ground Time Overcurrent

PATH: SETPOINTS ▾ ▾ S4 ELEMENTS ▾ ▾ GROUND OC ▾ W1(3) GND TIME OC

<div style="border: 1px solid black; padding: 2px;"> ■ W1 GND TIME OC </div>		<div style="border: 1px solid black; padding: 2px;"> W1 GROUND TIME OC FUNCTION: Enabled </div>	<i>Range: Enabled, Disabled</i>
MESSAGE		<div style="border: 1px solid black; padding: 2px;"> W1 GROUND TIME OC RLYS (1-8): ----- </div>	<i>Range: 1 to 8</i>
MESSAGE		<div style="border: 1px solid black; padding: 2px;"> W1 GROUND TIME OC TARGET: Latched </div>	<i>Range: Self-Reset, Latched, None</i>
MESSAGE		<div style="border: 1px solid black; padding: 2px;"> W1 GROUND TIME OC PICKUP: 0.85 x CT </div>	<i>Range: 0.05 to 20.00 x CT in steps of 0.01</i>
MESSAGE		<div style="border: 1px solid black; padding: 2px;"> W1 GROUND TIME OC SHAPE: Ext Inverse </div>	<i>Range: see description below</i>
MESSAGE		<div style="border: 1px solid black; padding: 2px;"> W1 GROUND TIME OC MULTIPLIER: 1.00 </div>	<i>Range: 0.00 to 100.00 in steps of 0.01</i>
MESSAGE		<div style="border: 1px solid black; padding: 2px;"> W1 GROUND TIME OC RESET: Linear </div>	<i>Range: Instantaneous, Linear</i>
MESSAGE		<div style="border: 1px solid black; padding: 2px;"> W1 GROUND TIME OC BLOCK: Disabled </div>	<i>Range: Logc Inpt 1 to 16, Virt Inpt 1 to 16, Output Rly 2 to 8, SelfTest Rly, Vir Outpt 1 to 5, Disabled</i>

- W1(3) GROUND TIME OC PICKUP:** Enter the level of ground current (in units of relay nominal current) above which the winding 1(3) ground time overcurrent element will pickup and start timing.
- W1(3) GROUND TIME OC SHAPE:** Select the time overcurrent curve shape to be used for the winding 1(3) ground time overcurrent element. Refer to *Time Overcurrent Curves* on page 5–58 for a description of the time overcurrent curve shapes.
- W1(3) GROUND TIME OC MULTIPLIER:** Enter the multiplier constant by which the selected time overcurrent curve shape (the base curve) is to be shifted in time.
- W1(3) GROUND TIME OC RESET:** Enter the multiplier constant by which the selected time overcurrent curve shape (the base curve) is to be shifted in time.

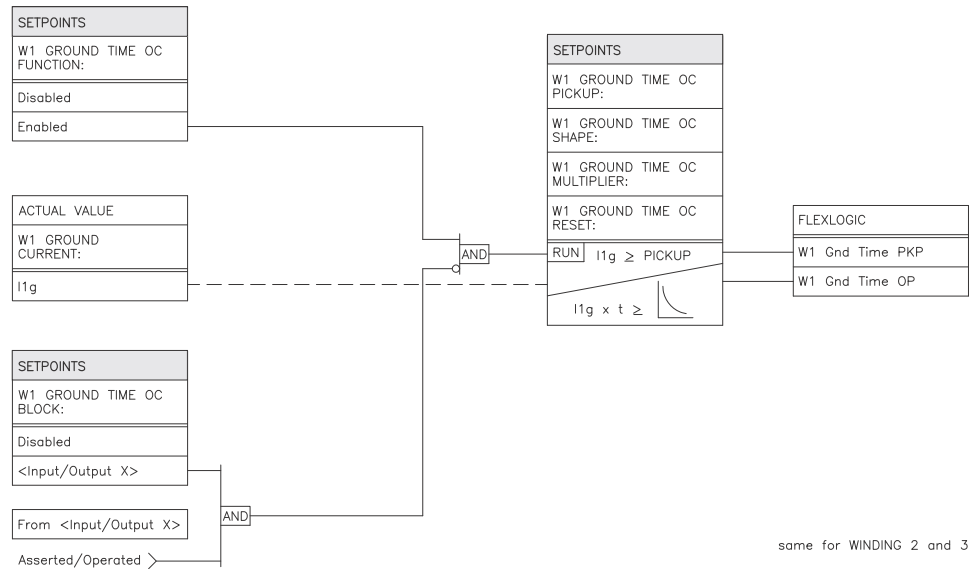

FIGURE 5-20: Ground time overcurrent scheme logic

5.6.7.3 Ground Instantaneous Overcurrent

PATH: SETPOINTS ▾ S4 ELEMENTS ▾ GROUND OC ▾ W1(3) GROUND INST OC 1(2)

■ W1 GND INST OC 1 >	W1 GROUND INST OC 1 FUNCTION: Disabled	Range: Enabled, Disabled
MESSAGE	W1 GROUND INST OC 1 RLYS (1-8): -----	Range: 1 to 8
MESSAGE	W1 GROUND INST OC 1 TARGET: Latched	Range: Self-Reset, Latched, None
MESSAGE	W1 GROUND INST OC 1 PICKUP: 10.00 x CT	Range: 0.05 to 20.00 x CT in steps of 0.01
MESSAGE	W1 GROUND INST OC 1 DELAY: 0 ms	Range: 0 to 60000 ms in steps of 1
MESSAGE	W1 GROUND INST OC 1 BLOCK: Disabled	Range: Logic Inpt 1 to 16, Virt Inpt 1 to 16, Output Rly 2 to 8, SelfTest Rly, Vir Output 1 to 5, Disabled

- **W1(3) GROUND INST OC 1(2) PICKUP:** Enter the level of ground current (in units of relay nominal current) above which the winding 1(3) ground instantaneous overcurrent 1 element will pickup and start the delay timer.
- **W1(3) GROUND INST OC 1(2) DELAY:** Enter the time that the ground current must remain above the pickup level before the element operates.



The messages above and scheme logic below are identical for windings 2 and 3 of ground instantaneous overcurrent 1 and all windings on the ground instantaneous overcurrent 2 element.

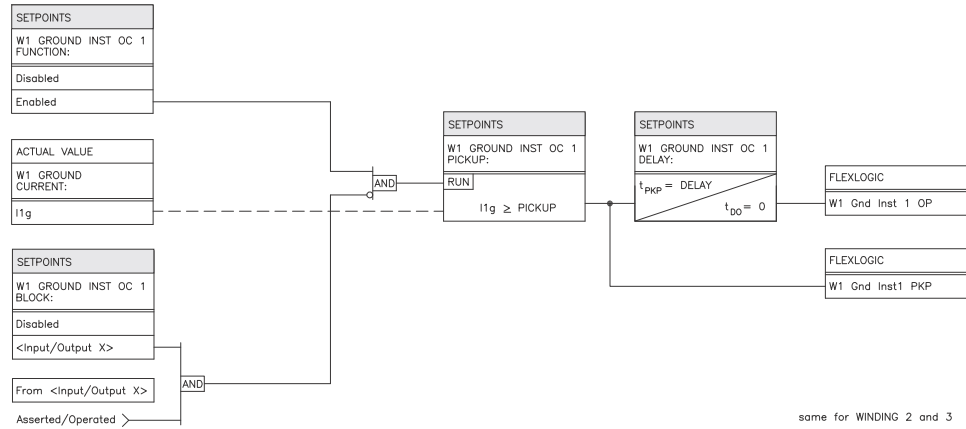

FIGURE 5-21: Ground instantaneous overcurrent scheme logic

5.6.8 Restricted Ground Fault

PATH: SETPOINTS ▷ S4 ELEMENTS ▷ RESTRICTED GROUND ▷ W1(3) RESTD GND FAULT

<div style="border: 1px solid black; padding: 2px; display: inline-block;"> ■ W1 RESTD GND FAULT </div>		W1 RESTD GND FAULT FUNCTION: Disabled	<i>Range: Enabled, Disabled</i>
MESSAGE		W1 RESTD GND FAULT RLYS (1-8): -----	<i>Range: 1 to 8</i>
MESSAGE		W1 RESTD GND FAULT TARGET: Latched	<i>Range: Self-Reset, Latched, None</i>
MESSAGE		W1 RESTD GND FAULT PICKUP: 0.08 x CT	<i>Range: 0.02 to 20.00 x CT in steps of 0.01</i>
MESSAGE		W1 RESTD GND FAULT SLOPE: 10%	<i>Range: 0 to 100% in steps of 1</i>
MESSAGE		W1 RESTD GND FAULT DELAY: 0.10 s	<i>Range: 0.00 to 600.00 s in steps of 0.01</i>
MESSAGE		W1 RESTD GND FAULT BLOCK: Disabled	<i>Range: Logic Inpt 1 to 16, Virt Inpt 1 to 16, Output Rly 2 to 8, SelfTest Rly, Vir Output 1 to 5, Disabled</i>

Restricted ground fault protection is often applied to transformers having impedance grounded wye. It is intended to provide sensitive ground fault detection for low magnitude fault currents which would not be detected by the percent differential element.

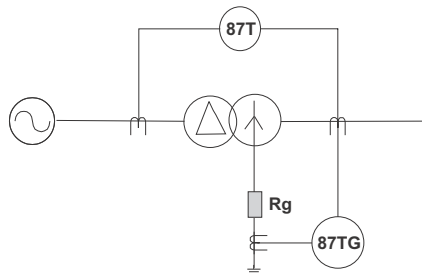

FIGURE 5-22: Restricted earth ground fault protection

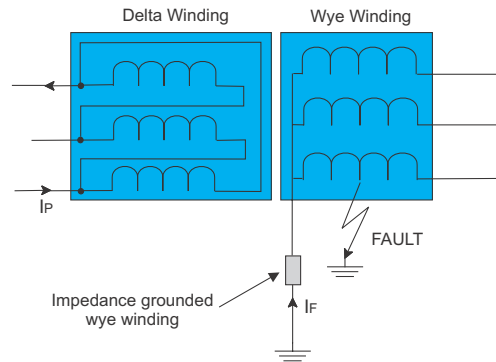

FIGURE 5-23: Resistance grounded wye wiring

An internal ground fault on an impedance grounded wye winding (see second figure above) produces a fault current (I_f) dependent on the value of the ground impedance and the position of the fault on the winding with respect to the neutral point. The resultant primary current (I_p) will be negligible for faults on the lower 30% of the winding since the fault voltage will not be the system voltage but the result of the transformation ratio between the primary windings and the percentage of shorted turns on the secondary. Therefore, the resultant differential currents could be below the slope threshold of the percent differential element and thus the fault could go undetected. The graph below shows the relationship between the primary (I_p) and fault (I_f) currents as a function of the distance of the fault point from the neutral and FIGURE 5-25: *RGF and percent differential zones of protection* outlines the zones of effective protection along the winding for an impedance grounded wye.

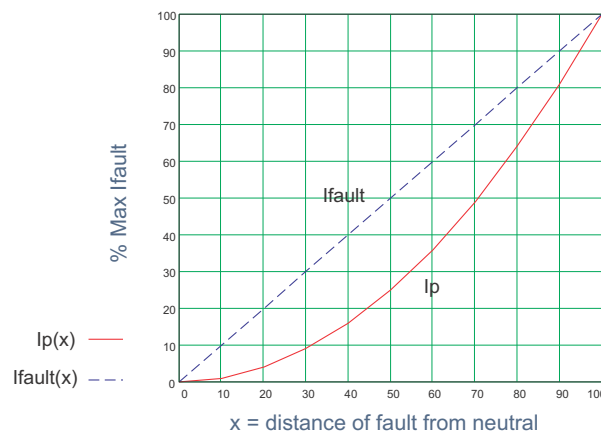

FIGURE 5-24: Fault currents vs. points from neutral

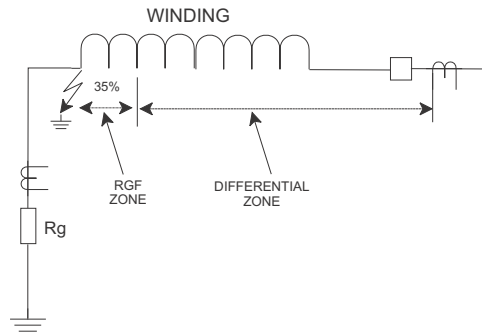

FIGURE 5-25: RGF and percent differential zones of protection

The 745 implementation of restricted ground fault (shown below) is a low impedance current differential scheme where “spill” current due to CT tolerances is handled via load bias similar to the percent differential. The 745 calculates the vectorial difference of the residual and ground currents (i.e. $3I_0 - I_g$) and divides this by the maximum line current (I_{max}) to produce a percent slope value. The slope setting allows the user to determine the sensitivity of the element based on the class and quality of the CTs used. Typically no more than 4% overall error due to CT “spill” is assumed for protection class CTs at nominal load.



The restricted ground fault protection is also available for delta windings with ground inputs as shown in table 3.2.

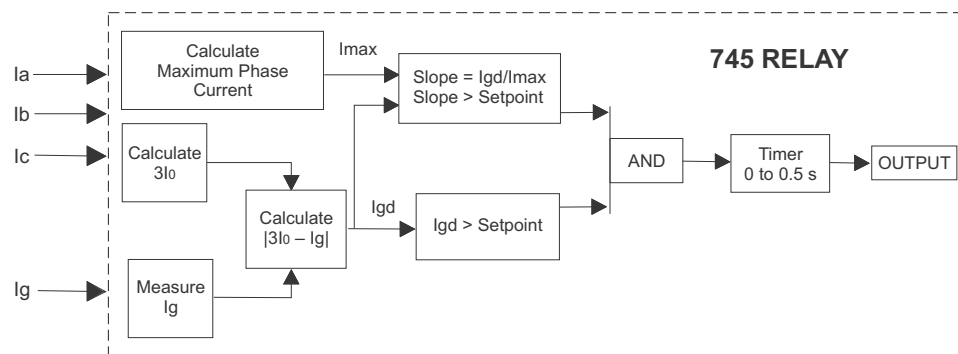

FIGURE 5-26: Restricted ground fault implementation

The issue of maloperation due to heavy external faults resulting in CT saturation is handled by a programmable timer. The timer provides the necessary delay for the external fault to be cleared by the appropriate external protection with the added benefit that if the RGF element remains picked up after the timer expires, the 745 operates and clears the fault. This approach provides backup protection. Since the restricted ground fault element is targeted at detecting low magnitude internal winding fault currents, the time delay for internal faults is of little consequence, since sensitivity and security are the critical parameters.

For example, consider a transformer with the following specifications:

10 MVA, 33 kV to 11 kV, 10% impedance, delta/wye 30,
 $R_g = 6.3$ ohms,
 Phase CT ratio = 600 / 1 A,
 Rated load current $I_{rated} = 10 \text{ MVA} / (\sqrt{3} \times 11 \text{ kV}) = 525 \text{ A}$,
 Maximum phase-to-ground fault current $I_{gf(max)} = 11 \text{ kV} / (\sqrt{3} \times 6.3) = 1000 \text{ A}$.

For a winding fault point at 5% distance from the neutral:

$$I_{fault} = 0.05 \times I_{gf(max)} = 0.05 \times 1000 \text{ A} = 50 \text{ A} \tag{EQ 5.10}$$

From FIGURE 5-24: *Fault currents vs. points from neutral* on page 5-73, we see that the I_p increase due to the fault is negligible and therefore $3I_0 = 0$ (approximately). Therefore, the maximum phase current = $I_{max} = I_{rated} = 525 \text{ A}$ (approximately), and

$$I_{gd} = |3I_0 - I_g| = \left| 0 - \frac{I_{fault}}{\text{phase CT primary}} \right| = \left| 0 - \frac{50 \text{ A}}{600} \right| = 0.08 \times \text{CT} = \text{pickup setting}$$

$$\text{Slope} = \frac{I_{gd}}{I_{max}} = \frac{50 \text{ A}}{525 \text{ A}} = 9.5\% \text{ (select slope setting} = 9\%) \tag{EQ 5.11}$$

Time delay: dependent on downstream protection coordination (100 ms typical)

The winding 1 restricted ground fault setpoints are described below:

- **W1(3) RESTD GND FAULT PICKUP:** Enter the minimum level of ground differential current (in units of phase CT primary associated with the winding, where the restricted ground fault is set) for the winding 1(3) restricted ground fault element.
- **W1(3) RESTD GND FAULT SLOPE:** Enter a slope percentage (of ground differential current to maximum line current).
- **W1(3) RESTD GND FAULT DELAY:** Enter the time that the winding 1(3) restricted ground fault element must remain picked up before the element operates.

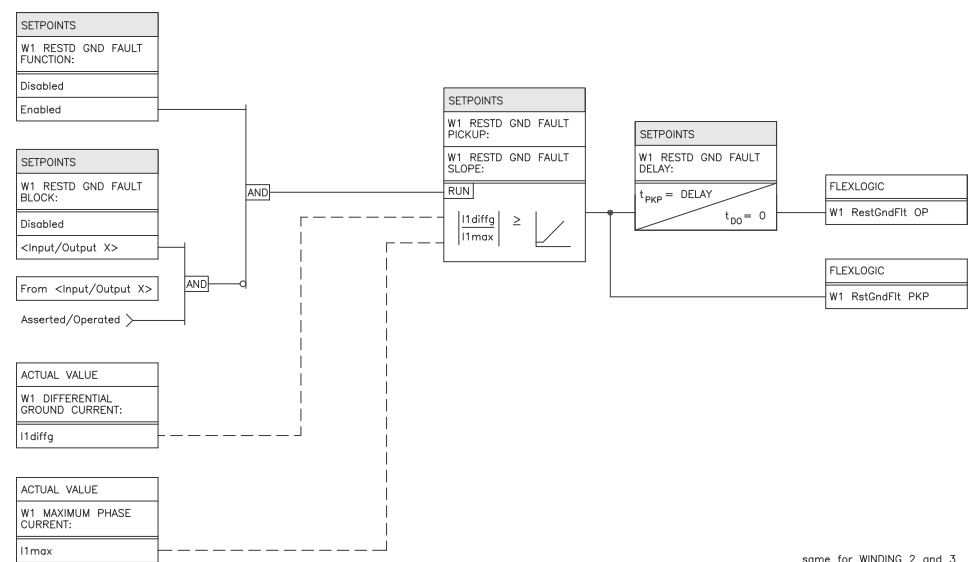

FIGURE 5-27: Restricted ground fault scheme logic

5.6.9 Negative Sequence Overcurrent

5.6.9.1 Main Menu

PATH: SETPOINTS ▾ ▾ S4 ELEMENTS ▾ ▾ NEG SEQ OC

■ NEG SEQ OC ▷		■ W1 NEG SEQ TIME OC ▷	See page 5-76
MESSAGE		■ W2 NEG SEQ TIME OC ▷	See page 5-76
MESSAGE		■ W3 NEG SEQ TIME OC ▷	See page 5-76
MESSAGE		■ W1 NEG SEQ INST OC ▷	See page 5-77
MESSAGE		■ W2 NEG SEQ INST OC ▷	See page 5-77
MESSAGE		■ W3 NEG SEQ INST OC ▷	See page 5-77

This section contains the settings to configure the negative sequence overcurrent elements. Included are negative sequence time overcurrents for each winding, and negative sequence instantaneous overcurrents for each winding.

5.6.9.2 Negative Sequence Time Overcurrent

PATH: SETPOINTS ▾ ▾ S4 ELEMENTS ▾ ▾ NEG SEQ OC ▾ W1(3) NEG SEQ TIME OC

■ W1 NEG SEQ TIME OC ▷		W1 NEG SEQ TIME OC FUNCTION: Enabled	Range: Enabled, Disabled
MESSAGE		W1 NEG SEQ TIME OC RLYS (1-8): -----	Range: 1 to 8
MESSAGE		W1 NEG SEQ TIME OC TARGET: Latched	Range: Self-Reset, Latched, None
MESSAGE		W1 NEG SEQ TIME OC PICKUP: 0.25 x CT	Range: 0.05 to 20.00 x CT in steps of 0.01
MESSAGE		W1 NEG SEQ TIME OC SHAPE: Ext Inverse	Range: see description below
MESSAGE		W1 NEG SEQ TIME OC MULTIPLIER: 1.00	Range: 0.00 to 100.00 in steps of 0.01
MESSAGE		W1 NEG SEQ TIME OC RESET: Linear	Range: Instantaneous, Linear
MESSAGE		W1 NEG SEQ TIME OC BLOCK: Disabled	Range: Logc Inpt 1 to 16, Virt Inpt 1 to 16, Output Rly 2 to 8, SelfTest Rly, Vir Output 1 to 5, Disabled

- **W1 (3) NEG SEQ TIME OC PICKUP:** Enter the level of negative sequence current (in units of relay nominal current) above which the winding 1(3) negative sequence time overcurrent element will pickup and start timing.
- **W1 (3) NEG SEQ TIME OC SHAPE:** Select the time overcurrent curve shape to be used for the winding 1(3) negative sequence time overcurrent element. Refer to *Time Overcurrent Curves* on page 5-58 for a description of the time overcurrent curve shapes.

- **W1 (3) NEG SEQ TIME OC MULTIPLIER:** Enter the multiplier constant by which the selected time overcurrent curve shape (the base curve) is to be shifted in time.
- **W1 (3) NEG SEQ TIME OC RESET:** Select the “Linear” reset to coordinate with electromechanical time overcurrent relays, in which the reset characteristic (when the current falls below the reset threshold before tripping) is proportional to ratio of “energy” accumulated to that required to trip. Select the “Instantaneous” reset to coordinate with relays, such as most static units, with instantaneous reset characteristics.

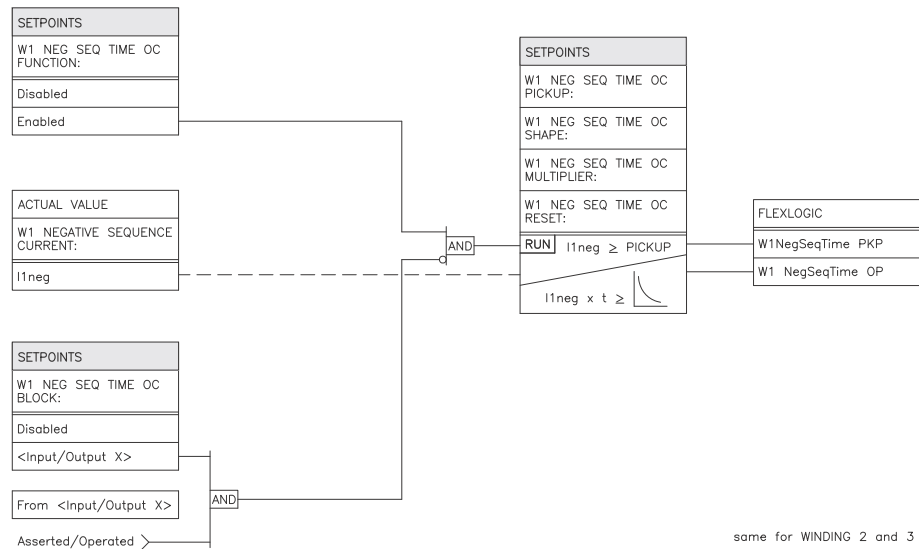

FIGURE 5–28: Negative sequence time overcurrent scheme logic

5.6.9.3 Negative Sequence Instantaneous Overcurrent

PATH: SETPOINTS ▾ S4 ELEMENTS ▾ NEG SEQ OC ▾ W1(3) NEG SEQ INST OC

■ W1 NEG SEQ INST OC	Function: Disabled	Range: Enabled, Disabled
MESSAGE W1 NEG SEQ INST OC RLYS (1-8): -----		Range: 1 to 8
MESSAGE W1 NEG SEQ INST OC TARGET: Latched		Range: Self-Reset, Latched, None
MESSAGE W1 NEG SEQ INST OC PICKUP: 10.00 x CT		Range: 0.05 to 20.00 x CT in steps of 0.01
MESSAGE W1 NEG SEQ INST OC DELAY: 0 ms		Range: 0 to 60000 ms in steps of 1
MESSAGE W1 NEG SEQ INST OC BLOCK: Disabled		Range: Logc Inpt 1 to 16, Virt Inpt 1 to 16, Output Rly 2 to 8, SelfTest Rly, Vir Outpt 1 to 5, Disabled

- **W1(3) NEG SEQ INST OC PICKUP:** Enter the level of negative sequence current (in units of relay nominal current) above which the winding 1(3) negative sequence instantaneous overcurrent element will pickup and start the delay timer.
- **W1(3) NEG SEQ INST OC DELAY:** Enter the time that the negative sequence current must remain above the pickup level before the element operates.

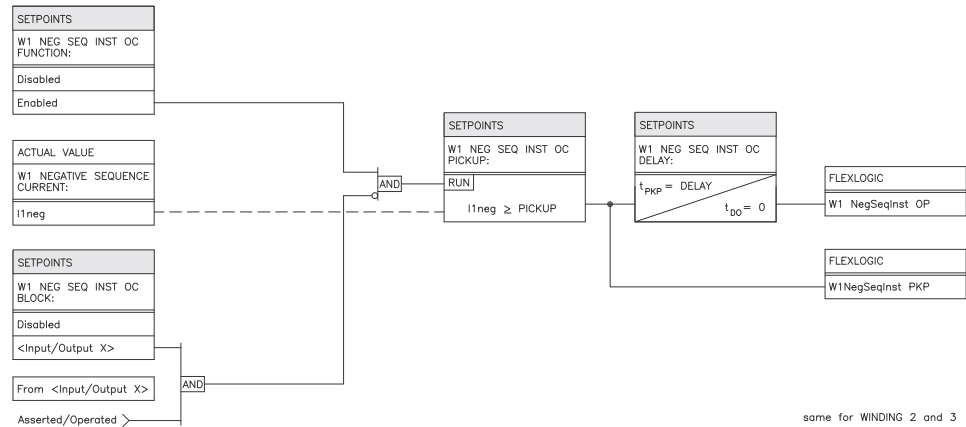
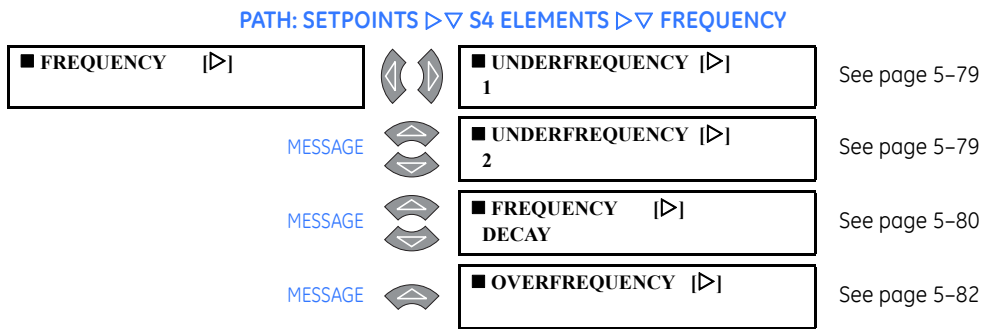

FIGURE 5-29: Negative sequence instantaneous overcurrent logic

5.6.10 Frequency

5.6.10.1 Main Menu



The 745 can be used as the primary detecting relay in automatic load shedding schemes based on underfrequency. This need arises if, during a system disturbance, an area becomes electrically isolated from the main system and suffers generation deficiency due to loss of either transmission or generation facilities. If reserve generation is not available in the area, conditions of low system frequency occur that may lead to a complete collapse. The 745 provides a means of automatically disconnecting sufficient load to restore an acceptable balance between load and generation.

The 745 uses both frequency and frequency rate-of-change as the basis for its operating criteria. These measured values are based on the voltage input or, if voltage is disabled, the winding 1 phase A current input. The relay has two (2) underfrequency and four (4) rate-of-change levels. Thus, four or more separate blocks of load can be shed, according to the severity of the disturbance.

In addition to these elements, the 745 has an overfrequency element. A significant overfrequency condition, likely caused by a breaker opening and disconnecting load from a particular generation location, can be detected and used to quickly ramp the turbine speed back to normal. If this is not done, the overspeed can lead to a turbine trip which would require a turbine start up before restoring the system. If the turbine speed can be controlled successfully, system restoration can be much quicker. The overfrequency element of the 745 can be used for this purpose at a generating location.



We strongly recommend the use of either the voltage, current, or both, signals for supervision. If no supervising conditions are enabled, the element could produce undesirable operation!

5.6.10.2 Underfrequency

PATH: SETPOINTS ▾ S4 ELEMENTS ▾ FREQUENCY ▾ UNDERFREQUENCY 1(2)

■ UNDERFREQUENCY [▷] 1		UNDERFREQUENCY 1 FUNCTION: Disabled	Range: Enabled, Disabled
MESSAGE		UNDERFREQUENCY 1 RLYS (1-8): -----	Range: 1 to 8
MESSAGE		UNDERFREQUENCY 1 TARGET: Self-Reset	Range: Self-Reset, Latched, None
MESSAGE		CURRENT SENSING: Enabled	Range: Enabled, Disabled
MESSAGE		MINIMUM OPERATING CURRENT: 0.20 x CT	Range: 0.05 to 1.00 x CT in steps of 0.01
MESSAGE		MINIMUM OPERATING VOLTAGE: 0.50 x VT	Range: 0.10 to 0.99 x CT in steps of 0.01
MESSAGE		UNDERFREQUENCY 1 PICKUP: 59.00 Hz	Range: 45.00 to 59.99 Hz in steps of 0.01
MESSAGE		UNDERFREQUENCY 1 DELAY: 1.00 s	Range: 0.00 to 600.00 s in steps of 0.01
MESSAGE		UNDERFREQUENCY 1 BLOCK: Disabled	Range: Logc Inpt 1 to 16, Virt Inpt 1 to 16, Output Rly 2 to 8, SelfTest Rly, Vir Outpt 1 to 5, Disabled

- **MINIMUM OPERATING CURRENT:** Enter the minimum value of winding 1 phase A current (in units of relay nominal current) required to allow the underfrequency element to operate.
- **MINIMUM OPERATING VOLTAGE:** Enter the minimum value of voltage (in units of relay nominal voltage) required to allow the underfrequency element to operate.
- **UNDERFREQUENCY 1(2) PICKUP:** Enter the frequency (in Hz) below which the underfrequency 1 element will pickup and start the delay timer.
- **UNDERFREQUENCY 1(2) DELAY:** Enter the time the frequency remains below the pickup level before element operation.

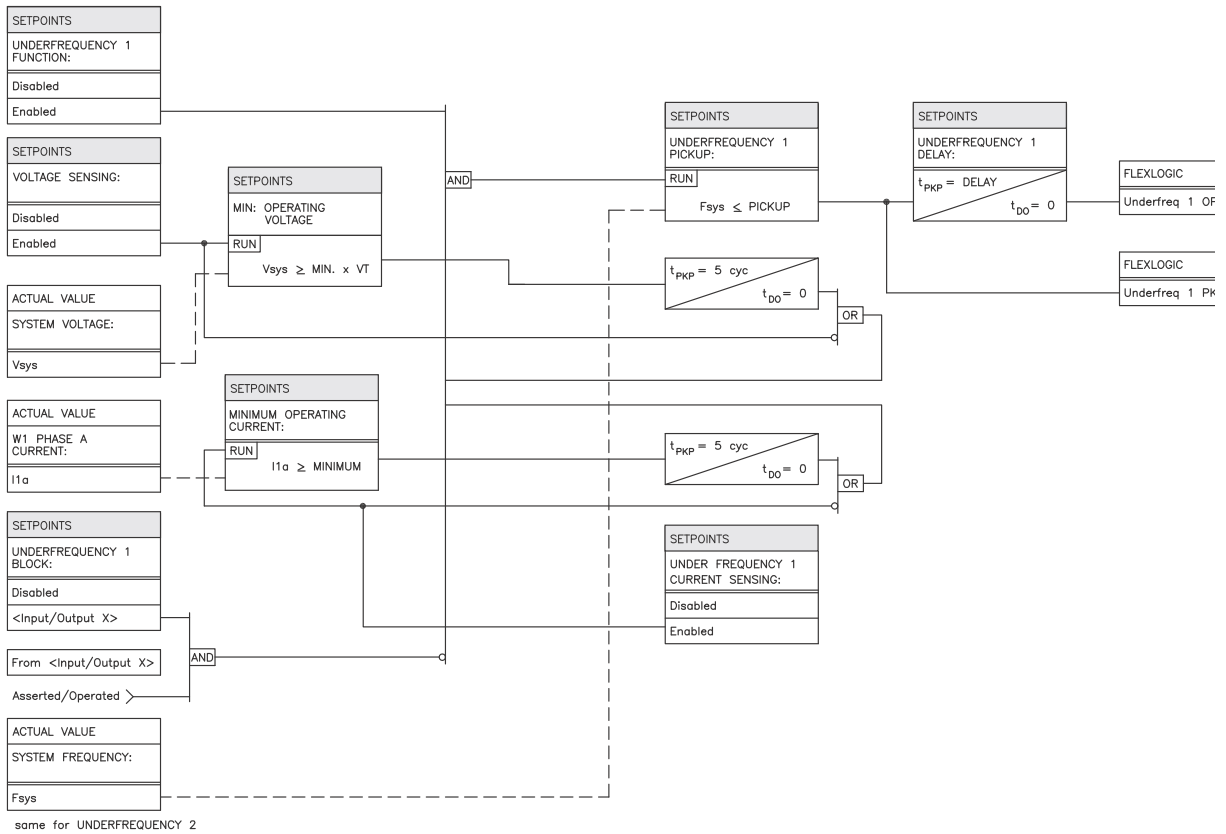

FIGURE 5–30: Underfrequency 1 scheme logic

5.6.10.3 Frequency Decay

PATH: SETPOINTS ▾ ▾ S4 ELEMENTS ▾ ▾ FREQUENCY ▾ ▾ FREQUENCY DECAY

FREQUENCY DECAY [▷]		FREQUENCY DECAY FUNCTION: Disabled	Range: Enabled, Disabled
MESSAGE		FREQUENCY DECAY RLYS (1-8): -----	Range: 1 to 8
MESSAGE		FREQUENCY DECAY TARGET: Self-Reset	Range: Self-Reset, Latched, None
MESSAGE		CURRENT SENSING: Enabled	Range: Enabled, Disabled
MESSAGE		MINIMUM OPERATING CURRENT: 0.20 x CT	Range: 0.05 to 1.00 x CT in steps of 0.01
MESSAGE		MINIMUM OPERATING VOLTAGE: 0.50 x VT	Range: 0.10 to 0.99 x CT in steps of 0.01
MESSAGE		FREQUENCY DECAY THRESHOLD: 59.50 Hz	Range: 45.00 to 59.99 Hz in steps of 0.01
MESSAGE		FREQUENCY DECAY DELAY: 0.00 s	Range: 0.00 to 600.00 s in steps of 0.01
MESSAGE		FREQUENCY DECAY RATE 1: 0.4 Hz/s	Range: 0.1 to 5.0 Hz/s in steps of 0.1

MESSAGE		FREQUENCY DECAY RATE 2: 1.0 Hz/s	Range: 0.1 to 5.0 Hz/s in steps of 0.1
MESSAGE		FREQUENCY DECAY RATE 3: 2.0 Hz/s	Range: 0.1 to 5.0 Hz/s in steps of 0.1
MESSAGE		FREQUENCY DECAY RATE 4: 4.0 Hz/s	Range: 0.1 to 5.0 Hz/s in steps of 0.1
MESSAGE		FREQUENCY DECAY BLOCK: Disabled	Range: Logc Inpt 1 to 16, Virt Inpt 1 to 16, Output Rly 2 to 8, SelfTest Rly, Vir Outpt 1 to 5, Disabled

- **MINIMUM OPERATING CURRENT:** Enter the minimum value of winding 1 phase A current (in units of relay nominal current) required to allow the frequency decay element to operate.
- **MINIMUM OPERATING VOLTAGE:** Enter the minimum value of voltage (in units of relay nominal voltage) required to allow the underfrequency element to operate.
- **FREQUENCY DECAY THRESHOLD:** Enter the frequency (in Hz) below which the four frequency rate of change levels of the frequency decay element will be allowed to operate.
- **FREQUENCY DECAY RATE 1(4):** Enter the rate of frequency decay beyond which the corresponding element operates.

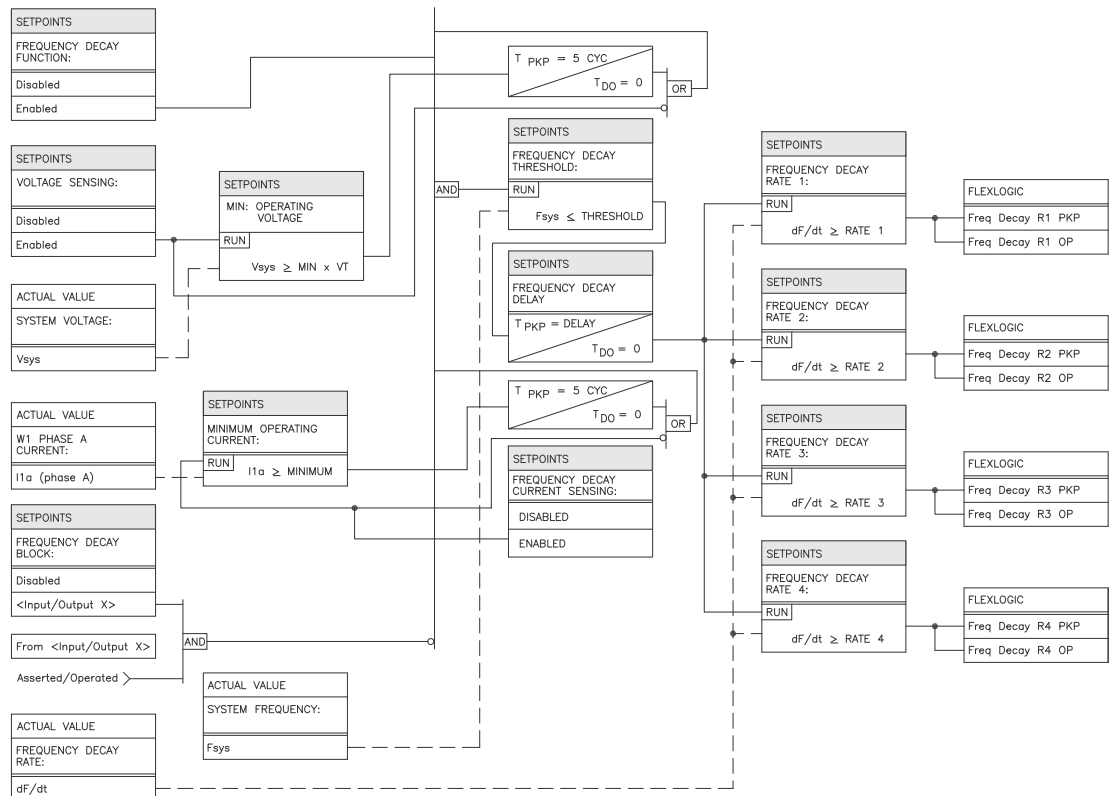

FIGURE 5-31: Frequency decay scheme logic

5.6.10.4 Overfrequency

PATH: SETPOINTS ▷ S4 ELEMENTS ▷ FREQUENCY ▷ OVERFREQUENCY 1(2)

■ OVERFREQUENCY [▷]		OVERFREQUENCY FUNCTION: Disabled	Range: Enabled, Disabled
MESSAGE		OVERFREQUENCY RLYS (1-8): -----	Range: 1 to 8
MESSAGE		OVERFREQUENCY TARGET: Latched	Range: Self-Reset, Latched, None
MESSAGE		CURRENT SENSING: Enabled	Range: Enabled, Disabled
MESSAGE		MINIMUM OPERATING CURRENT: 0.20 x CT	Range: 0.05 to 1.00 x CT in steps of 0.01
MESSAGE		MINIMUM OPERATING VOLTAGE: 0.50 x VT	Range: 0.10 to 0.99 x CT in steps of 0.01
MESSAGE		OVERFREQUENCY PICKUP: 60.50 Hz	Range: 50.01 to 65.00 Hz in steps of 0.01
MESSAGE		OVERFREQUENCY DELAY: 5.00 s	Range: 0.00 to 600.00 s in steps of 0.01
MESSAGE		OVERFREQUENCY BLOCK: Disabled	Range: Logc Inpt 1 to 16, Virt Inpt 1 to 16, Output Rly 2 to 8, SelfTest Rly, Vir Outpt 1 to 5, Disabled

- **MINIMUM OPERATING CURRENT:** Enter the minimum value of winding 1 phase A current (in units of relay nominal current) required to allow the overfrequency element to operate.
- **MINIMUM OPERATING VOLTAGE:** Enter the minimum voltage value (in units of relay nominal voltage) required to allow overfrequency to operate.
- **OVERFREQUENCY PICKUP:** Enter the frequency (in Hz) above which the overfrequency element will pickup and start the delay timer.

- OVERFREQUENCY DELAY:** Enter the time that the frequency must remain above the pickup level before the element operates.

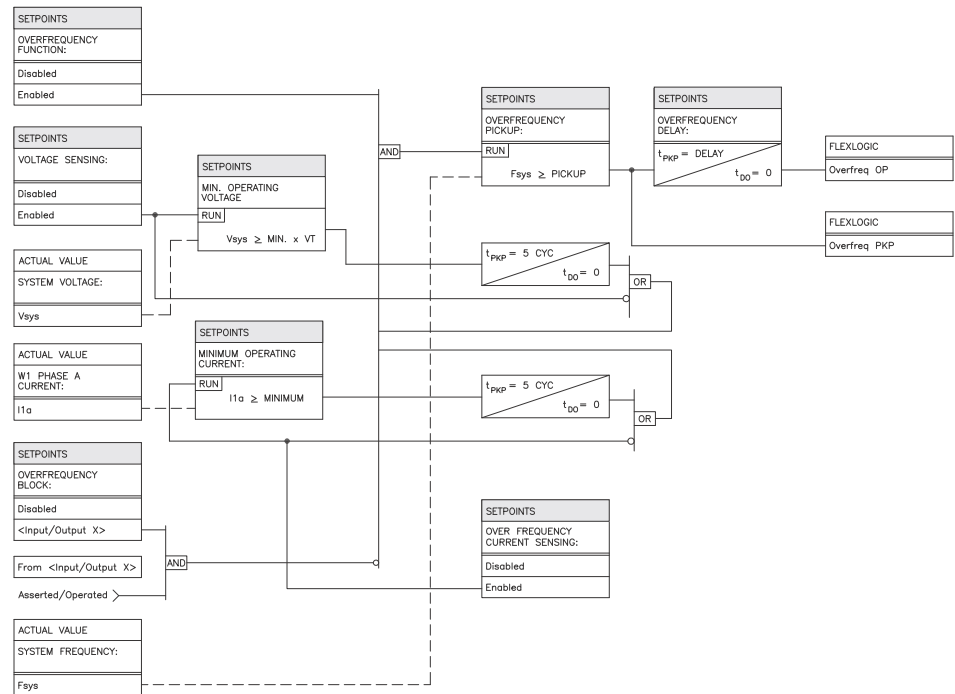

FIGURE 5-32: Overfrequency scheme logic

5.6.11 Overexcitation

5.6.11.1 Main Menu

PATH: SETPOINTS ▾ S4 ELEMENTS ▾ OVEREXCITATION

OVEREXCITATION ▷ MESSAGE MESSAGE	◀ ▶ ◀ ▶ ◀ ▶	5th HARMONIC LEVEL ▷ VOLTS PER HERTZ 1 ▷ VOLTS PER HERTZ 2 ▷	See page 5-84 See page 5-85 See page 5-85
---	-------------------	--	---

A transformer is designed to operate at or below a maximum magnetic flux density in the transformer core. Above this design limit the eddy currents in the core and nearby conductive components cause overheating which within a very short time may cause severe damage. The magnetic flux in the core is proportional to the voltage applied to the winding divided by the impedance of the winding. The flux in the core increases with either increasing voltage or decreasing frequency. During startup or shutdown of generator-connected transformers, or following a load rejection, the transformer may experience an excessive ratio of volts to hertz, that is, become overexcited.

When a transformer core is overexcited, the core is operating in a non-linear magnetic region, and creates harmonic components in the exciting current. A significant amount of current at the 5th harmonic is characteristic of overexcitation.

This section contains the settings to configure the overexcitation monitoring elements. Included are a 5th harmonic level, and two volts-per-hertz elements, each with a pickup level and a time delay.

5.6.11.2 Fifth Harmonic Level

PATH: SETPOINTS ▾ ▾ S4 ELEMENTS ▾ ▾ OVEREXCITATION ▾ 5th HARMONIC LEVEL

<p>■ 5th HARMONIC LEVEL [▷]</p>		<p>5th HARMONIC LEVEL FUNCTION: Disabled</p>	<p>Range: Enabled, Disabled</p>
MESSAGE		5th HARMONIC LEVEL RLYS (1-8): -----	Range: 1 to 8
MESSAGE		5th HARMONIC LEVEL TARGET: Self-Reset	Range: Self-Reset, Latched, None
MESSAGE		MINIMUM OPERATING CURRENT: 0.10 x CT	Range: 0.03 to 1.00 x CT in steps of 0.01
MESSAGE		5th HARMONIC LEVEL PICKUP: 10.0% f ₀	Range: 0.1 to 99.9% f ₀ in steps of 0.1
MESSAGE		5th HARMONIC LEVEL DELAY: 10 s	Range: 0 to 60000 s in steps of 1
MESSAGE		5th HARMONIC LEVEL BLOCK: Disabled	Range: Logc Inpt 1 to 16, Virt Inpt 1 to 16, Output Rly 2 to 8, SelfTest Rly, Vir Outpt 1 to 5, Disabled

- **MINIMUM OPERATING CURRENT:** Enter the minimum value of current (in units of relay nominal current) required to allow the 5th harmonic level element to operate.
- **5TH HARMONIC LEVEL PICKUP:** Enter the 5th harmonic current (in %f₀) above which the 5th harmonic level element will pickup and start the delay timer.
- **5TH HARMONIC LEVEL DELAY:** Enter the time that the 5th harmonic current must remain above the pickup level before the element operates.

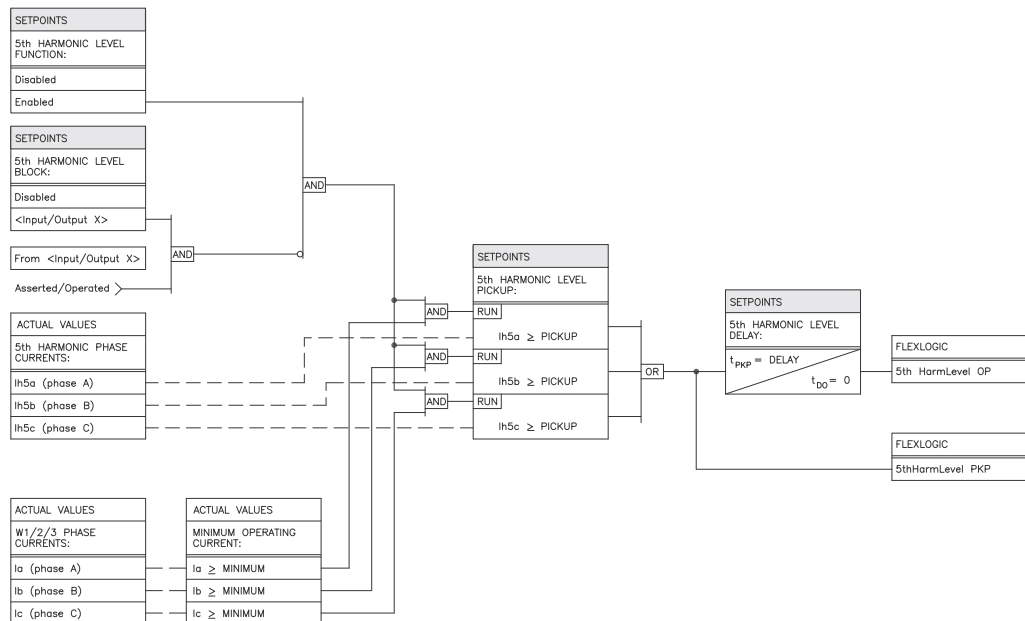

FIGURE 5–33: 5th harmonic level scheme logic

5.6.11.3 Volts per Hertz

PATH: SETPOINTS ▾ S4 ELEMENTS ▾ OVEREXCITATION ▾ VOLTS PER HERTZ 1(2)

■ VOLTS PER HERTZ 1			VOLTS-PER-HERTZ 1 FUNCTION: Disabled	Range: Enabled, Disabled
MESSAGE			VOLTS-PER-HERTZ RLYS (1-8): -----	Range: 1 to 8
MESSAGE			VOLTS-PER-HERTZ 1 TARGET: Self-Reset	Range: Self-Reset, Latched, None
MESSAGE			MINIMUM OPERATING VOLTAGE: 0.10 x VT	Range: 0.10 to 0.99 x VT in steps of 0.01
MESSAGE			VOLTS-PER-HERTZ 1 PICKUP: 2.36 V/Hz	Range: 1.00 to 4.00 V/Hz in steps of 0.01
MESSAGE			VOLTS-PER-HERTZ 1 SHAPE: Definite Time	Range: Definite Time, Inv Curve 1, Inv Curve 2, Inv Curve 3
MESSAGE			VOLTS-PER-HERTZ 1 DELAY: 2.00 s	Range: 0.00 to 600.00 s in steps of 0.01
MESSAGE			VOLTS-PER-HERTZ 1 RESET: 0.0 s	Range: 0.0 to 6000.0 s in steps of 0.1
MESSAGE			VOLTS-PER-HERTZ 1 BLOCK: Disabled	Range: Logc Inpt 1 to 16, Virt Inpt 1 to 16, Output Rly 2 to 8, SelfTest Rly, Vir Output 1 to 5, Disabled

The volts per hertz element uses the ratio of the actual measured voltage at the voltage terminal and the measured system frequency. For example, a measured phases-to-phase voltage of 120 volts at 60 Hz, results in a ratio of 2 V/Hz. For 115% overload, the setting of the volts per hertz minimum pickup would be 2.3 V/Hz.

The element has a linear reset characteristic. The reset time can be programmed to match the cooling characteristic of the protected equipment. The element will fully reset after the **VOLTS-PER-HERTZ RESET** value. The volts per hertz function can be used as an instantaneous element with no intentional delay, as a definite time element, or as an inverse timed element.

- **MINIMUM OPERATING VOLTAGE:** Enter the minimum value of voltage (in terms of nominal VT secondary voltage) required to allow the volts per hertz 1 element to operate.
- **VOLTS-PER-HERTZ 1 PICKUP:** Enter the volts per hertz value (in V/Hz) above which the volts per hertz 1 element will pickup and start the delay timer.
- **VOLTS-PER-HERTZ 1 SHAPE:** Select the curve shape to be used for the volts per hertz 1 element. The inverse volts per hertz curve shapes are shown below.
- **VOLTS-PER-HERTZ 1 DELAY:** Enter the time that the volts per hertz value must remain above the pickup level before the element operates.
- **VOLTS-PER-HERTZ 1 RESET:** Enter the time that the volts per hertz value must remain below the pickup level before the element resets.

The curve for the inverse curve 1 shape is derived from the formula:

$$T = \frac{D}{\left(\frac{V/F}{\text{Pickup}}\right)^2 - 1} \quad \text{when } \frac{V}{F} > \text{Pickup} \quad (\text{EQ 5.12})$$

where: T = operate time (in seconds)
 D = delay setpoint (in seconds)
 V = fundamental RMS value of voltage (V)
 F = frequency of voltage signal (Hz)
 $Pickup$ = volts per hertz pickup setpoint (V/Hz)

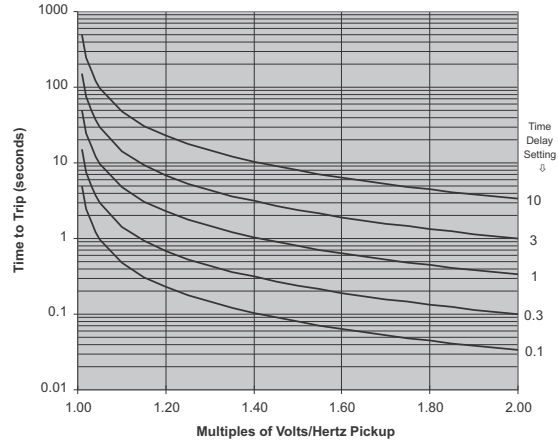

FIGURE 5-34: Volts per hertz curve 1

The curve for the inverse curve 2 shape is derived from the formula:

$$T = \frac{D}{\frac{V/F}{Pickup} - 1} \quad \text{when } \frac{V}{F} > Pickup \quad \text{(EQ 5.13)}$$

where: T = operate time (in seconds)
 D = delay setpoint (in seconds)
 V = fundamental RMS value of voltage (V)
 F = frequency of voltage signal (Hz)
 $Pickup$ = volts per hertz pickup setpoint (V/Hz)

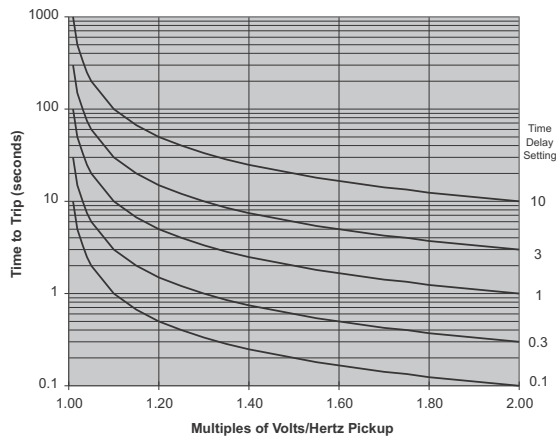

FIGURE 5-35: Volts per hertz curve 2

The curve for the inverse curve 3 shape is derived from the formula:

$$T = \frac{D}{\left(\frac{V/F}{\text{Pickup}}\right)^{0.5} - 1} \quad \text{when } \frac{V}{F} > \text{Pickup} \tag{EQ 5.14}$$

- where T = operate time (in seconds)
- D = delay setpoint (in seconds)
- V = fundamental RMS value of voltage (V)
- F = frequency of voltage signal (Hz)
- Pickup = volts-per-hertz pickup setpoint (V/Hz)

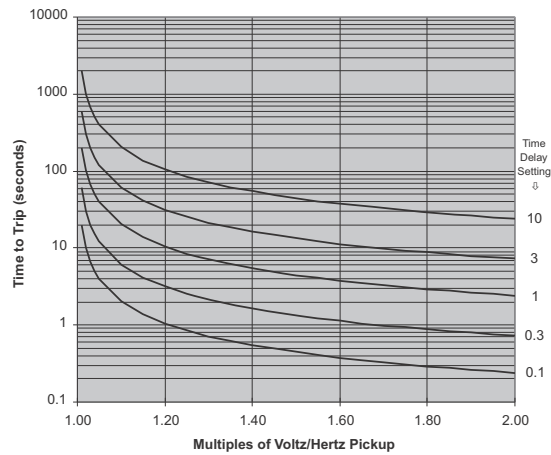

FIGURE 5-36: Volts per hertz curve 3

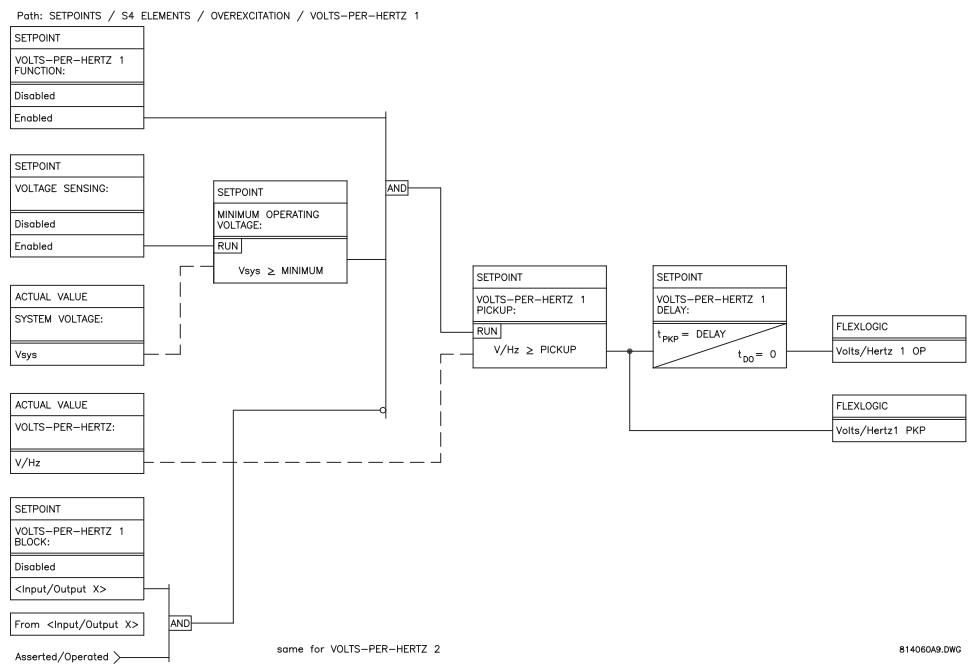

FIGURE 5-37: Volts per hertz scheme logic

5.6.12 Harmonics

5.6.12.1 Main Menu

PATH: SETPOINTS ▾ ▾ S4 ELEMENTS ▾ ▾ HARMONICS

■ HARMONICS ▷		■ W1 THD LEVEL ▷	See page 5-88
MESSAGE		■ W2 THD LEVEL ▷	See page 5-88
MESSAGE		■ W3 THD LEVEL ▷	See page 5-88
MESSAGE		■ W1 HARMONIC DERATING ▷	See page 5-89
MESSAGE		■ W2 HARMONIC DERATING ▷	See page 5-89
MESSAGE		■ W3 HARMONIC DERATING ▷	See page 5-89

This section contains the settings to configure the total harmonic distortion monitoring elements. Included are a THD level element for each winding and each phase.

5.6.12.2 THD Level

PATH: SETPOINTS ▾ ▾ S4 ELEMENTS ▾ ▾ HARMONICS ▾ W1(3) THD LEVEL

■ W1 THD LEVEL ▷		W1 THD LEVEL FUNCTION: Disabled	Range: Enabled, Disabled
MESSAGE		W1 THD LEVEL RLYS (1-8): -----	Range: 1 to 8
MESSAGE		W1 THD LEVEL TARGET: Self-Reset	Range: Self-Reset, Latched, None
MESSAGE		MINIMUM OPERATING CURRENT: 0.10 x CT	Range: 0.03 to 1.00 x CT in steps of 0.01
MESSAGE		W1 THD LEVEL PICKUP: 50.0% f ₀	Range: 0.1 to 50.0% f ₀ in steps of 0.1
MESSAGE		W1 THD LEVEL DELAY: 10 s	Range: 0 to 60000 s in steps of 1
MESSAGE		W1 THD LEVEL BLOCK: Disabled	Range: Logc Inpt 1 to 16, Virt Inpt 1 to 16, Output Rly 2 to 8, SelfTest Rly, Vir Outpt 1 to 5, Disabled

- **MINIMUM OPERATING CURRENT:** Enter the minimum value of current (in units of relay nominal current) required to allow the THD level element to operate.
- **W1(3) THD PICKUP LEVEL:** Enter the total harmonic distortion (in %f₀) above which the winding 1(3) total harmonic distortion element level will pickup and start the delay timer.
- **W1(3) THD LEVEL DELAY:** Enter the time that the total harmonic distortion must remain above the pickup level before the element operates.

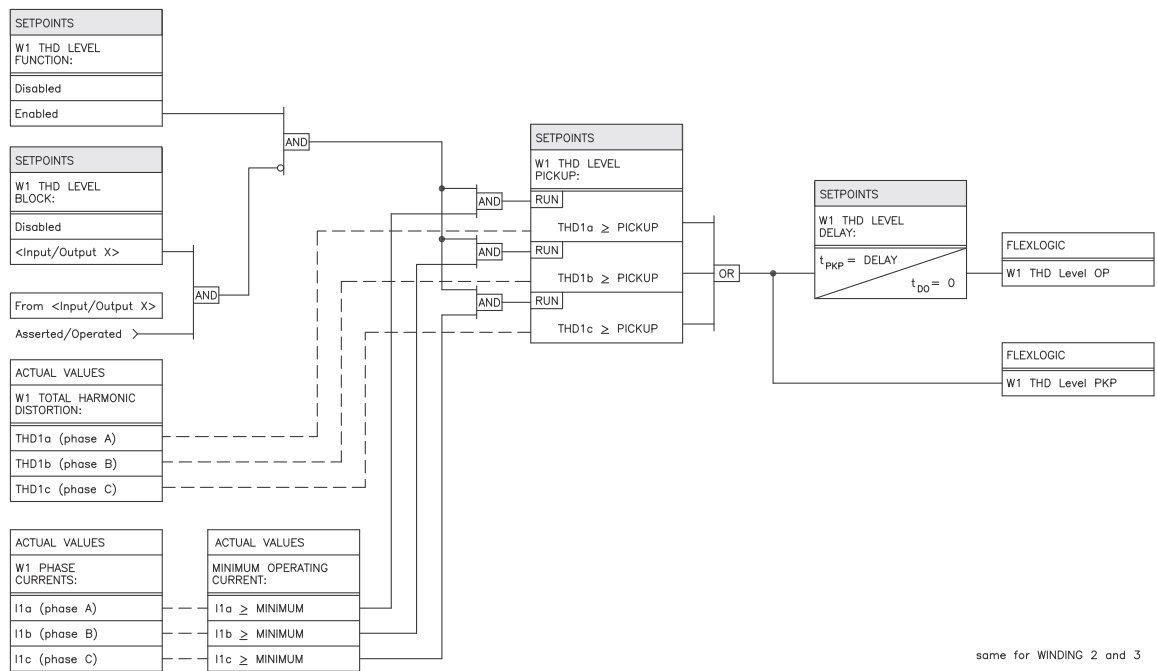

FIGURE 5-38: THD level scheme logic

5.6.12.3 Harmonic Derating

PATH: SETPOINTS ▾ ▾ S4 ELEMENTS ▾ ▾ HARMONICS ▾ ▾ W1(3) HARMONIC DERATING

<p>■ W1 HARMONIC DERATING [▷]</p>		<p>W1 HARM DERATING FUNCTION: Disabled</p>	<p>Range: Enabled, Disabled</p>
<p>MESSAGE</p>		<p>W1 HARM DERATING RLYS (1-8): -----</p>	<p>Range: 1 to 8</p>
<p>MESSAGE</p>		<p>W1 HARM DERATING TARGET: Self-Reset</p>	<p>Range: Self-Reset, Latched, None</p>
<p>MESSAGE</p>		<p>MINIMUM OPERATING CURRENT: 0.10 x CT</p>	<p>Range: 0.03 to 1.00 x CT in steps of 0.01</p>
<p>MESSAGE</p>		<p>W1 HARM DERATING PICKUP: 0.90</p>	<p>Range: 0.01 to 0.98 in steps of 0.01</p>
<p>MESSAGE</p>		<p>W1 HARM DERATING DELAY: 10 s</p>	<p>Range: 0 to 60000 s in steps of 1</p>
<p>MESSAGE</p>		<p>W1 HARM DERATING BLOCK: Disabled</p>	<p>Range: Logc Inpt 1 to 16, Virt Inpt 1 to 16, Output Rly 2 to 8, SelfTest Rly, Vir Outpt 1 to 5, Disabled</p>

- **MINIMUM OPERATING CURRENT:** Enter the minimum value of current (in units of relay nominal current) required to allow the harmonic derating element to operate.
- **W1(3) HARMONIC DERATING PICKUP:** Enter the harmonic derating below which the winding 1(3) harmonic derating will pickup and start the delay timer.
- **W1(3) HARMONIC DERATING DELAY:** Enter the time that the harmonic derating must remain below the pickup level before the element operates.

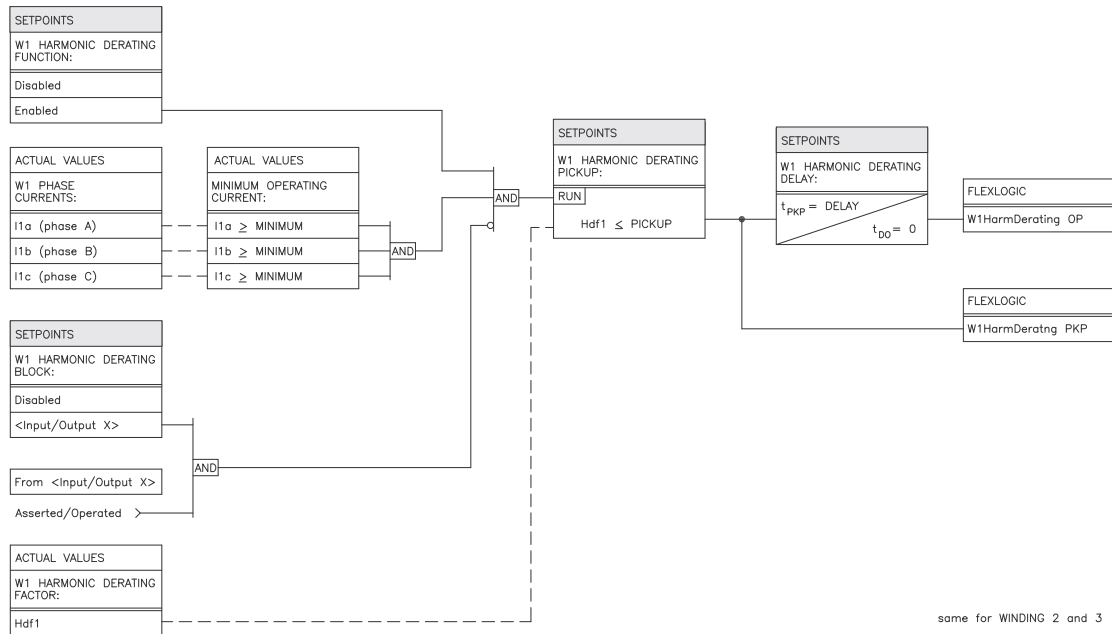

FIGURE 5-39: Harmonic derating scheme logic

same for WINDING 2 and 3

5.6.13 Insulation Aging

5.6.13.1 Main Menu

PATH: SETPOINTS ▾ ▾ S4 ELEMENTS ▾ ▾ INSULATION AGING

■ INSULATION AGING ▷	◀ ▶	■ HOTTEST-SPOT LIMIT ▷	See page 5-91
MESSAGE	◀ ▶	■ AGING FACTOR LIMIT ▷	See page 5-92
MESSAGE	◀ ▶	■ LOSS OF LIFE LIMIT ▷	See page 5-93

The 745 insulation aging / loss of life feature is based on the computational methods presented in IEEE standards C57.91-1995, *IEEE Guide for Loading Mineral-Oil-Immersed Transformers*, and C57.96-1989, *IEEE Guide for Loading Dry-Type Distribution and Power Transformers*. These standards present a method of computing the top oil temperature, the hottest spot inside the transformer, the aging factor, and the total accumulated loss of life. The computations are based on the loading of the transformer, the ambient temperature, and the transformer data entered. The computations assume that the transformer cooling system is fully operational and able to maintain transformer temperatures within the specified limits under normal load conditions.

The computation results are a guide only. The transformer industry has not yet been able to define, with any degree of precision, the exact end of life of a transformer. Many transformers are still in service today, though they have long surpassed their theoretical end of life, some of them by a factor of three or four times.

Three protection elements are provided as part of the Loss of Life feature. The first element monitors the hottest-spot temperature. The second element monitors the aging factor and the third monitors the total accumulated loss of life. Each element produces an output when the monitored quantity exceeds a set limit.







The insulation aging / loss of life feature is a field-upgradable feature. For the feature (and associated elements) to operate correctly, it must first be enabled under the factory settings using the passcode provided at purchase. If the feature was ordered when the relay was purchased, then it is already enabled. Note that setting this feature using the EnerVista 745 Setup software requires that it be enabled under **File > Properties > Loss of Life** menu. If the computer is communicating with a relay with the feature installed, it is automatically detected.

For the computations to be performed correctly, it is necessary to enter the transformer data under **S2 SYSTEM SETUP > TRANSFORMER**. The transformer load is taken from the winding experiencing the greatest loading. All transformer and winding setpoints must be correct or the computations will be meaningless.

The preferred approach for ambient temperature is to use an RTD connected to the 745. If this is not feasible, average values for each month of the year can be entered as settings, under **S2 SYSTEM SETUP > AMBIENT TEMPERATURE > AMBIENT RTD TYPE** and selecting "By Monthly Average".

5.6.13.2 Hottest Spot Limit

PATH: SETPOINTS > S4 ELEMENTS > INSULATION AGING > HOTTEST-SPOT LIMIT

■ HOTTEST-SPOT LIMIT [D]		HOTTEST-SPOT LIMIT FUNCTION: Disabled	Range: Enabled, Disabled
MESSAGE		HOTTEST-SPOT LIMIT RLYS (1-8): -----	Range: 1 to 8
MESSAGE		HOTTEST-SPOT LIMIT TARGET: Self-Reset	Range: Self-Reset, Latched, None
MESSAGE		HOTTEST-SPOT LIMIT PICKUP: 150°C	Range: 50 to 300°C in steps of 1
MESSAGE		HOTTEST-SPOT LIMIT DELAY: 10 min	Range: 0 to 60000 min. in steps of 1
MESSAGE		HOTTEST-SPOT LIMIT BLOCK: Disabled	Range: Logc Inpt 1 to 16, Virt Inpt 1 to 16, Output Rly 2 to 8, SelfTest Rly, Vir Outpt 1 to 5, Disabled

The hottest-spot limit element provides a means of detecting an abnormal hot spot inside the transformer. The element operates on the computed hottest-spot value. *The hottest-spot temperature will revert to 0°C for 1 minute if the power supply to the relay is interrupted.*

- HOTTEST SPOT LIMIT PICKUP:** Enter the hottest-spot temperature required for operation of the element. This setting should be a few degrees above the maximum permissible hottest-spot temperature under emergency loading condition and maximum ambient temperature.
- HOTTEST SPOT LIMIT DELAY:** Enter a time delay above which the hottest-spot temperature must remain before the element operates.

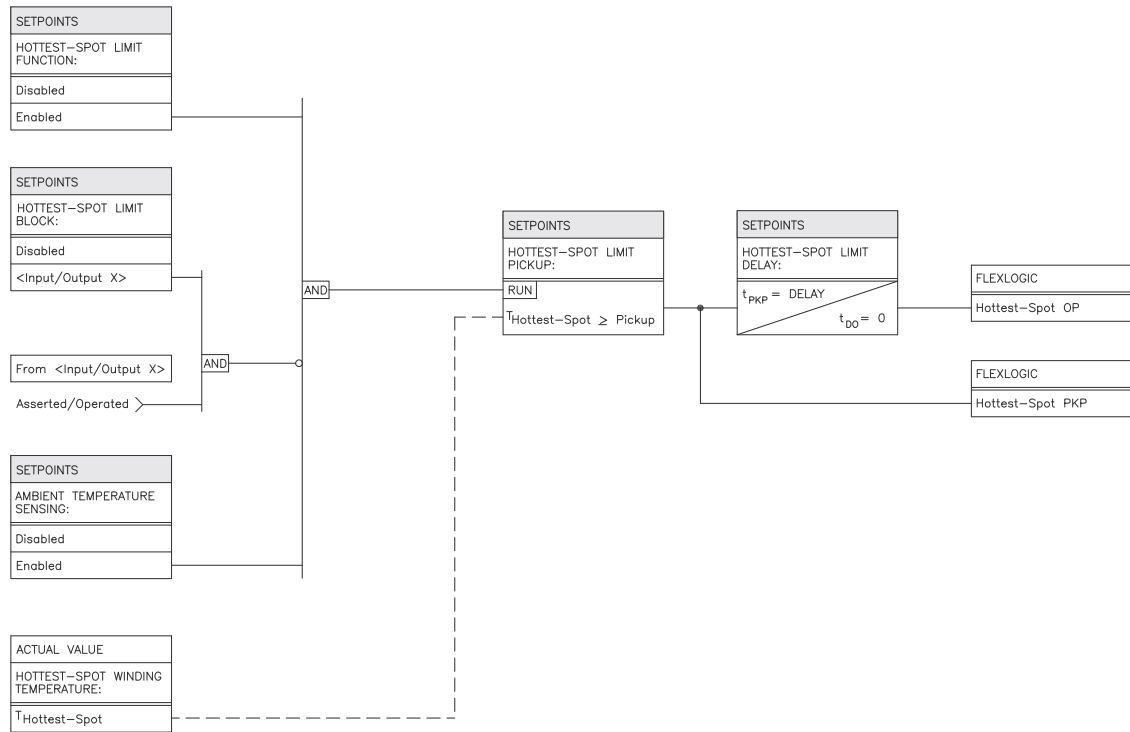

FIGURE 5-40: Hottest-spot limit scheme logic

5.6.13.3 Aging factor limit

PATH: SETPOINTS ▾ ▾ S4 ELEMENTS ▾ ▾ INSULATION AGING ▾ ▾ AGING FACTOR LIMIT

<p>■ AGING FACTOR LIMIT</p> <p>MESSAGE</p>		<p>AGING FACTOR LIMIT FUNCTION: Disabled</p> <p>Range: Enabled, Disabled</p>
<p>MESSAGE</p>		<p>AGING FACTOR LIMIT RLYS (1-8): -----</p> <p>Range: 1 to 8</p>
<p>MESSAGE</p>		<p>AGING FACTOR LIMIT TARGET: Self-Reset</p> <p>Range: Self-Reset, Latched, None</p>
<p>MESSAGE</p>		<p>AGING FACTOR LIMIT PICKUP: 2.0</p> <p>Range: 1.1 to 10.0 in steps of 0.1</p>
<p>MESSAGE</p>		<p>AGING FACTOR LIMIT DELAY: 10 min</p> <p>Range: 0 to 60000 min. in steps of 1</p>
<p>MESSAGE</p>		<p>AGING FACTOR LIMIT BLOCK: Disabled</p> <p>Range: Logc Inpt 1 to 16, Virt Inpt 1 to 16, Output Rly 2 to 8, SelfTest Rly, Vir Outpt 1 to 5, Disabled</p>

The aging factor limit element provides a means of detecting when a transformer is aging faster than would normally be acceptable. The element operates on the computed aging factor, which in turn is derived from the computed hottest-spot value. *The aging factor value will revert to zero if the power supply to the relay is interrupted.* The necessary settings required for this element to perform correctly are entered under:

- **AGING FACTOR LIMIT PICKUP:** Enter the aging factor required for operation of the element. This setting should be above the maximum permissible aging factor under emergency loading condition and maximum ambient temperature.

- AGING FACTOR LIMIT DELAY:** Enter a time delay above which the aging factor must remain before the element operates.

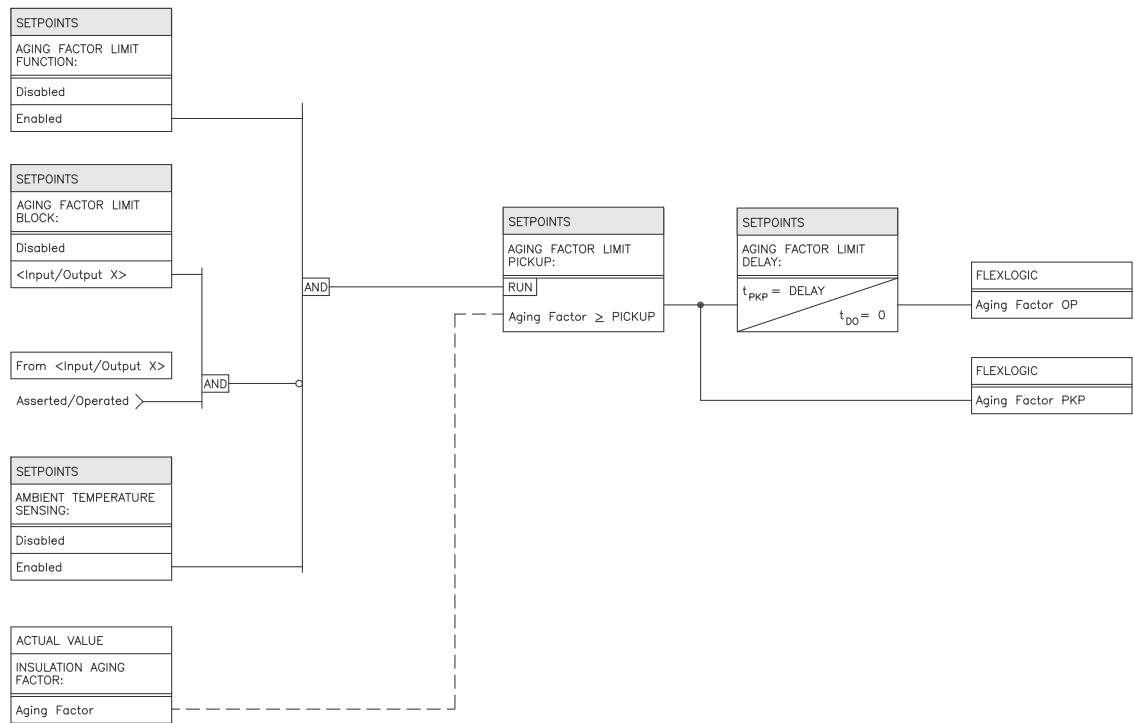

FIGURE 5–41: Aging factor limit scheme logic

5.6.13.4 Loss of Life Limit

PATH: SETPOINTS > S4 ELEMENTS > INSULATION AGING > LOSS OF LIFE LIMIT

■ LOSS OF LIFE LIMIT		LOSS OF LIFE LIMIT FUNCTION: Disabled	<i>Range: Enabled, Disabled</i>
MESSAGE		LOSS OF LIFE LIMIT RLYS (1-8): -----	<i>Range: 1 to 8</i>
MESSAGE		LOSS OF LIFE LIMIT TARGET: Self-Reset	<i>Range: Self-Reset, Latched, None</i>
MESSAGE		LOSS OF LIFE LIMIT PICKUP: 16000 x 10h	<i>Range: 0 to 20000 x 10h (a maximum of 20000 hrs.) in steps of 1</i>
MESSAGE		LOSS OF LIFE LIMIT BLOCK: Disabled	<i>Range: Logc Inpt 1 to 16, Virt Inpt 1 to 16, Output Rly 2 to 8, SelfTest Rly, Vir Outpt 1 to 5, Disabled</i>

The loss of life limit element computes the total expended life of the transformer, based on the aging factor and the actual in-service time of the transformer. For example, if the aging factor is a steady 1.5 over a time period of 10 hours, the transformer will have aged for an equivalent $1.5 \times 10 = 15$ hours. The cumulative total number of hours expended is retained in the relay even when control power is lost. The initial loss of life value, when a relay is first placed in service, can be programmed under the transformer settings. The element operates on the cumulative total value, with no time delay. The output of this element should be used as an alarm only, as users may wish to leave the transformer in service beyond the theoretical expended life.

Enter the expended life, in hours, required for operation of the element in the **LOSS OF LIFE PICKUP** setpoint. This setting should be above the total life of the transformer, in hours. As an example, for a 15-year transformer, the total number of hours would be $13140 \times 10 = 131400$ hours.



The actual values are only displayed if the loss of life option is installed and the ambient temperature is enabled.

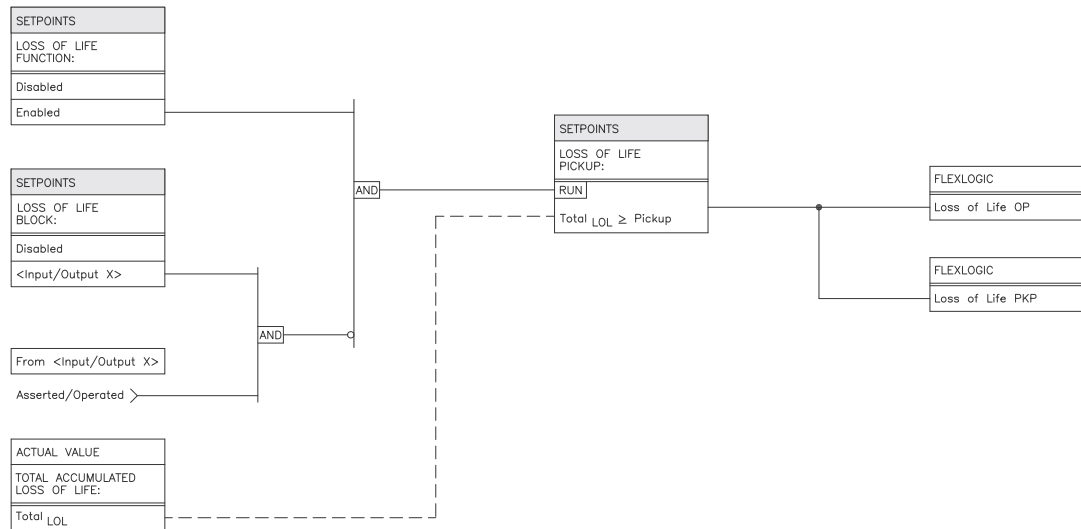

FIGURE 5-42: Loss-of-life scheme logic

5.6.14 Analog Input Level

PATH: SETPOINTS > S4 ELEMENTS > ANALOG INPUT > ANALOG LEVEL 1(2)

<div style="border: 1px solid black; padding: 2px; display: inline-block;"> ANALOG LEVEL 1 > </div>		ANALOG INPUT LEVEL 1 FUNCTION: Disabled	Range: Enabled, Disabled
MESSAGE		ANALOG INPUT LEVEL 1 RLYS (1-8): -----	Range: 1 to 8
MESSAGE		ANALOG INPUT LEVEL 1 TARGET: Self-Reset	Range: Self-Reset, Latched, None
MESSAGE		ANALOG INPUT LEVEL 1 PICKUP: 10 μA	Range: 1 to 65000 μA in steps of 1
MESSAGE		ANALOG INPUT LEVEL 1 DELAY: 50 s	Range: 0 to 60000 s in steps of 1
MESSAGE		ANALOG INPUT LEVEL 1 BLOCK: Disabled	Range: Logc Inpt 1 to 16, Virt Inpt 1 to 16, Output Rly 2 to 8, SelfTest Rly, Vir Outpt 1 to 5, Disabled

The 745 can monitor any external quantity, such as bus voltage, battery voltage, etc., via a general purpose auxiliary current input called the analog input. Any one of the standard transducer output ranges 0 to 1 mA, 0 to 5 mA, 4 to 20 mA, or 0 to 20 mA can be connected to the analog input terminals. The analog input is configured in **S2 SYSTEM SETUP > ANALOG INPUT** and the actual values displayed in **A2 METERING > ANALOG INPUT**.

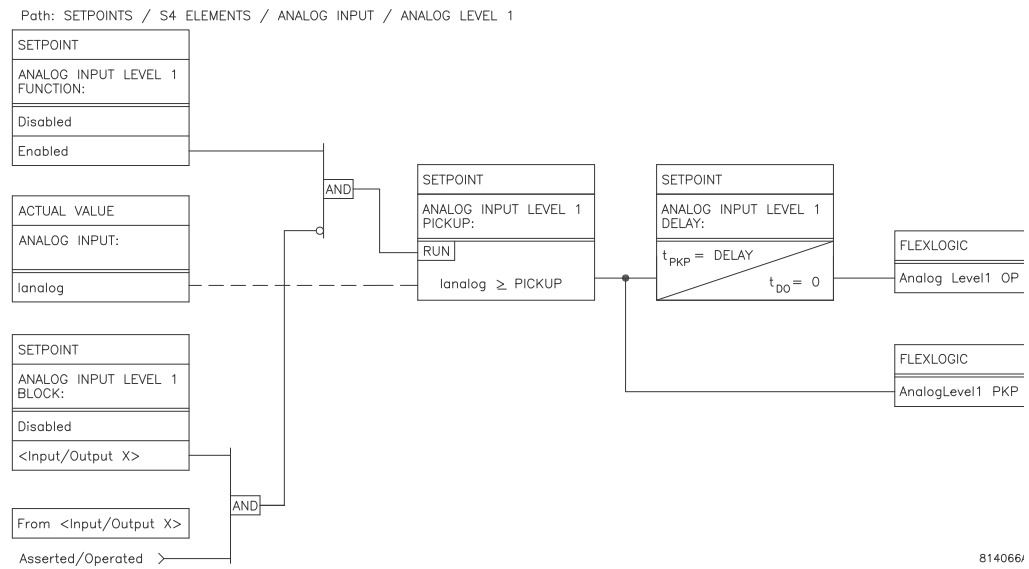

FIGURE 5-43: Analog level scheme logic

5.6.15 Current Demand

PATH: SETPOINTS ▾ S4 ELEMENTS ▾ CURRENT DEMAND ▾ W1(3) CURRENT DEMAND

■ CURRENT DEMAND [▷]		W1 CURRENT DEMAND FUNCTION: Disabled	Range: Enabled, Disabled
MESSAGE		W1 CURRENT DEMAND RLYS (1-8): -----	Range: 1 to 8
MESSAGE		W1 CURRENT DEMAND TARGET: Self-Reset	Range: Self-Reset, Latched, None
MESSAGE		W1 CURRENT DEMAND PICKUP: 100 A	Range: 0 to 100000 A in steps of 1 (auto-ranging)
MESSAGE		W1 CURRENT DEMAND BLOCK: Disabled	Range: Logc Inpt 1 to 16, Virt Inpt 1 to 16, Output Rly 2 to 8, SelfTest Rly, Vir Outpt 1 to 5, Disabled

This section contains the settings to configure the current demand monitoring elements. Included are a current demand level for each winding.

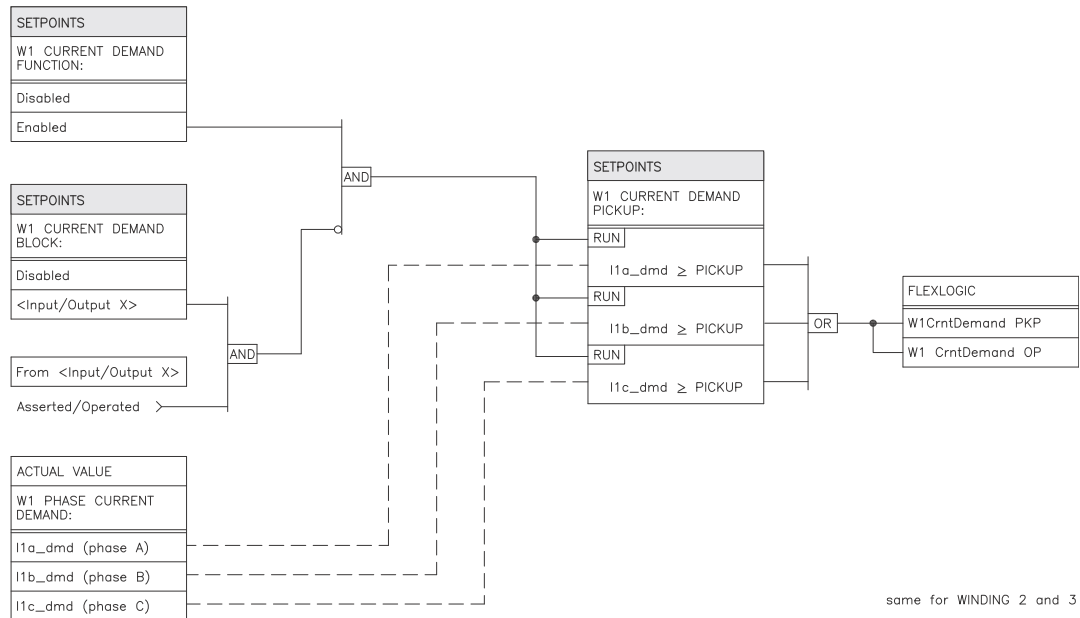

FIGURE 5-44: Current demand scheme logic

5.6.16 Transformer Overload

PATH: SETPOINTS ▷ S4 ELEMENTS ▷ XFMR OVERLOAD

■ XFMR OVERLOAD ▷		TRANSFORMER OVERLOAD FUNCTION: Disabled	Range: Enabled, Disabled
MESSAGE		TRANSFORMER OVERLOAD RLYS (1-8): -----	Range: 1 to 8
MESSAGE		TRANSFORMER OVERLOAD TARGET: Self-Reset	Range: Self-Reset, Latched, None
MESSAGE		TRANSFORMER OVERLOAD PICKUP: 208% rated	Range: 50 to 300% of Rated Load in steps of 1
MESSAGE		TRANSFORMER OVERLOAD DELAY: 10 s	Range: 0 to 60000 s in steps of 1
MESSAGE		TRANSFORMER OVERLOAD BLOCK: Disabled	Range: Logc Inpt 1 to 16, Virt Inpt 1 to 16, Output Rly 2 to 8, SelfTest Rly, Vir Output 1 to 5, Disabled
MESSAGE		XFMR OVERTEMP ALARM SIGNAL: Disabled	Range: Disabled, Logc Inpt 1 to 16

- TRANSFORMER OVERLOAD PICKUP:** This setting identifies the level of transformer overload, where the pickup delay starts timing. The setting is expressed as a percentage of the transformer base MVA rating, and is normally set at or above the maximum rated MVA from the transformer nameplate.
- XFMR OVERTEMP ALARM SIGNAL:** Select any logic input that, when asserted, indicates the transformer cooling system has failed and an over-temperature condition exists. The logic input should be connected to the transformer winding temperature alarm contacts.

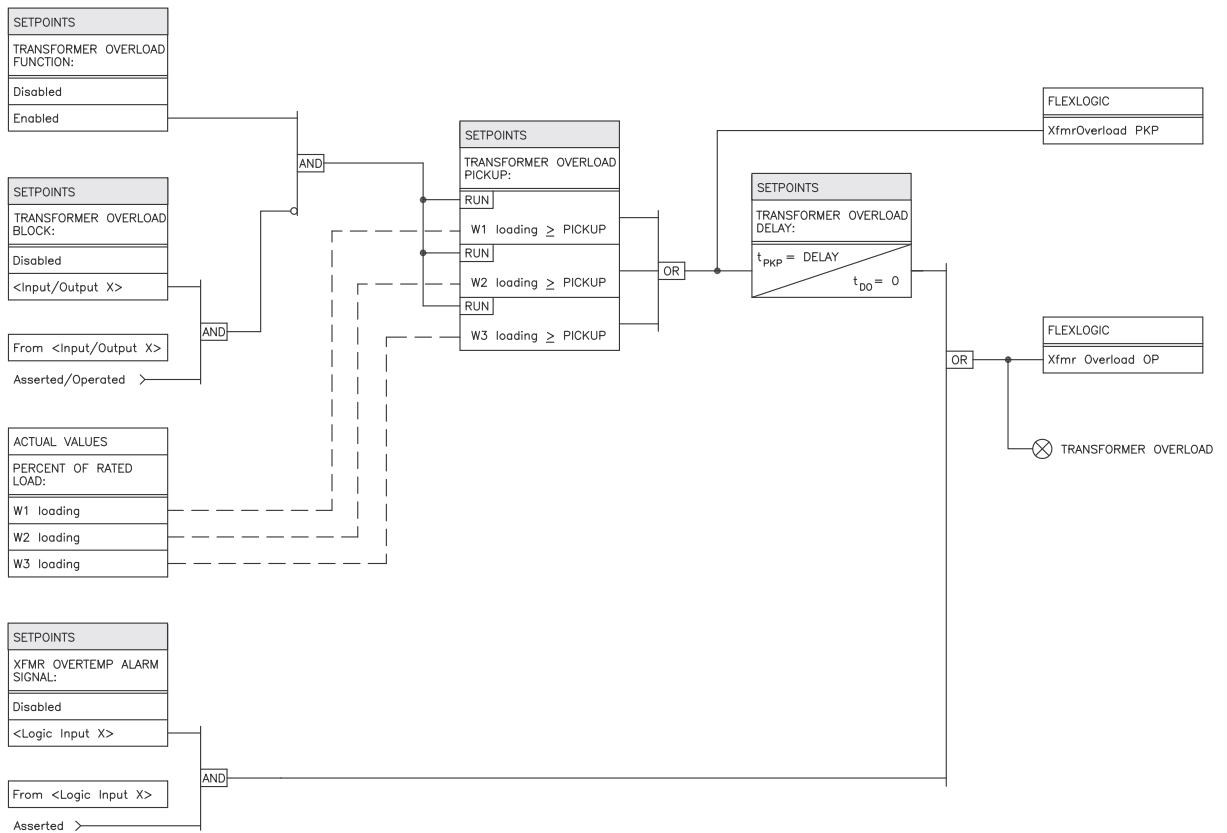

FIGURE 5-45: Transformer overload scheme logic

5.6.17 Tap Changer Failure

PATH: SETPOINTS ▾ S4 ELEMENTS ▾ TAP CHANGR FAILURE

■ TAP CHANGR FAILURE D		TAP CHANGER FAILURE FUNCTION: Disabled	Range: Enabled, Disabled
MESSAGE		TAP CHANGER FAILURE RLYS (1-8): -----	Range: 1 to 8
MESSAGE		TAP CHANGER FAILURE TARGET: Self-Reset	Range: Self-Reset, Latched, None
MESSAGE		TAP CHANGER FAILURE DELAY: 5.00 s	Range: 0.00 to 600.00 s in steps of 0.01
MESSAGE		TAP CHANGER FAILURE BLOCK: Disabled	Range: Logc Inpt 1 to 16, Virt Inpt 1 to 16, Output Rly 2 to 8, SelfTest Rly, Vir Outpt 1 to 5, Disabled

The tap changer failure element monitors the resistance seen by the tap changer monitoring circuit. The element produces an output signal when the tap changer position exceeds the maximum number of taps (set by the **NUMBER OF TAP POSITIONS** setpoint) by two. This signal can be used as an alarm or as a signal to change the setpoint group. A change in the setpoint group would be programmed through the FlexLogic™. This approach would be useful if very sensitive settings had been used in the normal in-service setpoint group for the harmonic restrained differential element, assuming that the tap changer position was used to compensate the input current magnitude.

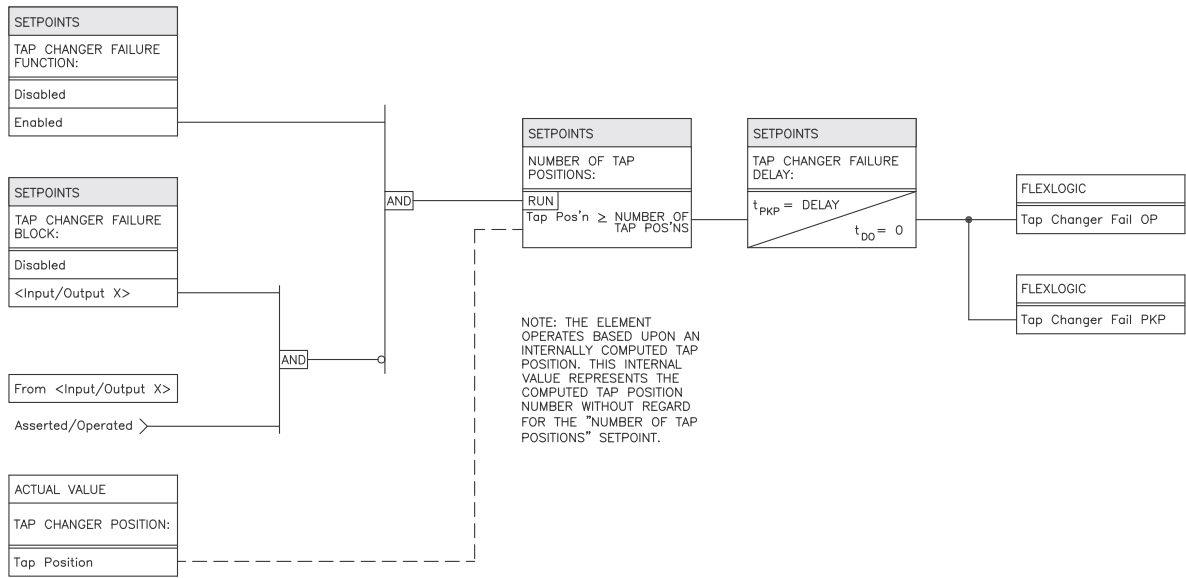

FIGURE 5-46: Tap changer failure scheme logic

5.7 S5 Outputs

5.7.1 Description

The S5 OUTPUTS page contains the settings to configure all outputs. The 745 has nine digital outputs (one solid-state, four trip-rated form A contacts, and four auxiliary form-C contacts), which are fully programmable from the relay unit, as well using FlexLogic™ equations.

In addition to these outputs, the conditions to trigger a waveform capture (trace memory) is also programmable using FlexLogic™. A ten parameter equation is provided for this purpose.

5.7.2 Relay Assignments

As an alternative to FlexLogic™ programming, the output auxiliary relays can be assigned directly from the element settings on the relay.

On the relay unit, every protection element settings page has a new setting to configure. The position of the setting is right between the function and the target settings of the element configuration. The relays selected from the elements page will be energized only on the operate condition of the protection element.

This new setting allows the user to assign relays directly to the protection element. The new settings have a default value for no relays assigned (None).

With the addition of the new setting, output relays can be energized from the protection element setting OR the FlexLogic™.

As an example, the new setting in the Percent Differential element will look like **PATH: SETPOINTS > ▾ S4 ELEMENTS > ▾ DIFFERENTIAL > PERCENT DIFFERENTIAL** (section 5.6.3.2).

5.7.3 Introduction to FlexLogic™

FlexLogic™ is a highly flexible and easy-to-use equation format which allows any combination of protection and monitoring elements, logic inputs, outputs, and timers to be assigned to any output, using multiple input AND, OR, NAND, NOR, XOR, and NOT Boolean logic gates. Each digital output can have an equation of up to 20 parameters. Five virtual outputs are also available, each having an equation containing up to 10 parameters, whose output can be used as a parameter in any other equation.

A FlexLogic™ equation defines the combination of inputs and logic gates to operate an output. Each output has its own equation, an equation being a linear array of parameters. Evaluation of an equation results in either a 1 (= ON, i.e. operate the output), or 0 (= OFF, i.e. do not operate the output).

The table below provides information about FlexLogic™ equations for all outputs:

Table 5–10: FlexLogic™ output types

Name	Type	Equation parameters	Evaluation rate
Output relay 1	solid-state	20	every 1/2 cycle*
Output relays 2 to 5	trip-rated form-A contacts	20 each	every 1/2 cycle*
Output relays 6 to 8	form-C contacts	20 each	every 100 ms
Self-test relay	form-C contacts dedicated for self-test (not programmable)	---	every 100 ms
Trace trigger	waveform capture trigger	10	every 1/2 cycle*
Virtual outputs	internal register (for use in other equations)	10 each	every 1/2 cycle*

* refers to the power system cycle as detected by the frequency circuitry of the 745.

As mentioned above, the parameters of an equation can contain either INPUTS or GATES.

Table 5–11: FlexLogic™ input types

Inputs	Input is "1" (= ON) if...
Element* pickup	The pickup setting of the element is exceeded
Element* operate	The pickup setting of the element is exceeded for the programmed time delay
Logic inputs 1 to 16	The logic input contact is asserted
Virtual inputs 1 to 16	The virtual input is asserted
Output relays 1 to 8	The output relay operates (i.e. evaluation of the FlexLogic™ equation results in a '1')
Virtual outputs 1 to 5	The virtual output operates (i.e. evaluation of the FlexLogic™ equation results in a '1')
Timers 1 to 10	The timer runs to completion (i.e. the 'start' condition is met for the programmed time delay)

* refers to any protection or monitoring element in page [S4 ELEMENTS](#).

Table 5–12: FlexLogic™ gates

Gates	Number of inputs	Output is "1" (= ON) if...
NOT	1	input is '0'
OR	2 to 19 (for 20 equation parameters) 2 to 9 (for 10 equation parameters)	any input is '1'
AND	2 to 19 (for 20 equation parameters) 2 to 9 (for 10 equation parameters)	all inputs are '1'
NOR	2 to 19 (for 20 equation parameters) 2 to 9 (for 10 equation parameters)	all inputs are '0'
NAND	2 to 19 (for 20 equation parameters) 2 to 9 (for 10 equation parameters)	any input is '0'
XOR	2 to 19 (for 20 equation parameters) 2 to 9 (for 10 equation parameters)	odd number of inputs are '1'

Inputs and gates are combined into a FlexLogic™ equation. The sequence of entries in the linear array of parameters follows the general rules listed in the following section.

5.7.4 FlexLogic™ Rules

The general FlexLogic™ rules are listed below.

1. Inputs to a gate always precede the gate in the equation.

2. Gates have only one output.
3. The output of a gate can be the input to another gate. Therefore, according to rule 1, the former gate will precede the latter gate in the equation.
4. Any input can be used more than once in an equation.
5. The output of an equation can be used as an input to any equation (including feedback to itself).
6. If all parameters of an equation are not used, the 'END' parameter must follow the last parameter used.

As an example, assume that the following logic is required to operate output relay 2:

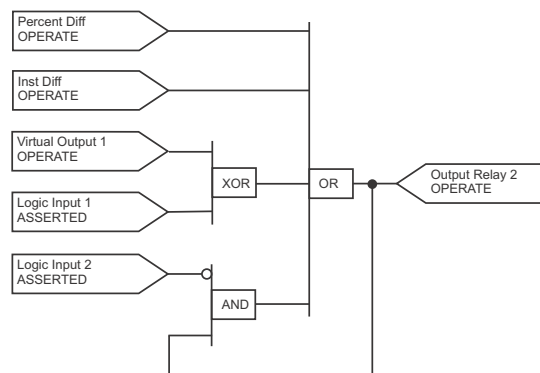

FIGURE 5–47: FlexLogic™ example

Based on the rules given above, the output relay 2 FlexLogic™ equation is shown above. On the left is a stack of boxes showing the FlexLogic™ messages for output relay 2. On the right of the stack of boxes is an illustration of how the equation is interpreted.

In this example, the inputs of the four-input OR gate are [Percent Diff OP](#), [Inst Diff OP](#), the output of the XOR gate, and the output of the AND gate. The inputs of the two-input AND gate are the output of the NOT gate, and [Output Relay 2](#). The input to the NOT gate is [Logic Input 2](#). The inputs to the two-input XOR gate are [Virtual Output 1](#) and [Logic Input 1](#). For all these gates, the inputs precede the gate itself.

This ordering of parameters of an equation, where the gate (or “operator”) follows the input (or “value”) is commonly referred to as “postfix” or “Reverse Polish” notation.

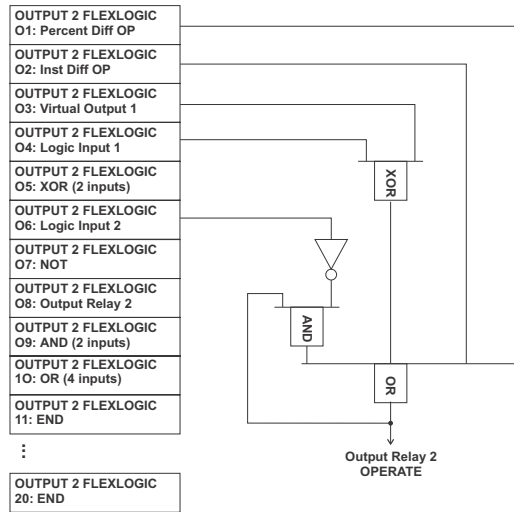

FIGURE 5–48: FlexLogic™ example implemented

Any equation entered in the 745 that does not make logical sense according to the notation described here, will be flagged as a self-test error. The **SELF TEST ERROR: FlexLogic Eqn** message will be displayed until the error is corrected.

5.7.5 Output Relays

PATH: SETPOINTS ▾ ▾ S5 OUTPUTS ▾ OUTPUT RELAYS ▾ OUTPUT RELAY 1(8)

■ OUTPUT RELAY 1 ▷	↔	OUTPUT 1 NAME: Solid State Trip	Range: 18 alphanumeric characters
MESSAGE	↕	OUTPUT 1 OPERATION: Self-Resetting	Range: Self-Resetting, Latched
MESSAGE	↕	OUTPUT 1 TYPE: Trip	Range: Trip, Alarm, Control
MESSAGE	↕	OUTPUT 1 FLEXLOGIC 01: Percent Diff Op	Range: any FlexLogic™ input or gate
	↓		
MESSAGE	↕	OUTPUT 1 FLEXLOGIC 20: END	Range: any FlexLogic™ input or gate

This section contains the settings (including the FlexLogic™ equation) to configure output relays 1 to 8.

- **OUTPUT 1(8) NAME:** Press ENTER edit the name of the output. The text may be changed from “Solid State Trip” one character at a time, using the VALUE keys. Press ENTER to store the edit and advance to the next character position.
- **OUTPUT 1(8) OPERATION:** Select “Latched” to maintain the output 1(8) contacts in the energized state, even after the condition that caused the contacts to operate is cleared, until a reset command is issued (or automatically after one week). Select “Self-reset” to automatically de-energize the contacts after the condition is cleared. The solid state output (output 1) remains closed until externally reset by a momentary

interruption of current, unless wired in parallel with an electromechanical relay (outputs 2 to 8) in which case it turns off when the relay operates.

- **OUTPUT 1(8) TYPE:** Select “Trip” to turn the Trip LED on or “Alarm” to turn the Alarm LED on when this output operates. Otherwise, select “Control”. Note that the Trip LED remains on until a reset command is issued (or automatically after one week). The Alarm LED turns off automatically when the output is no longer operated.
- **OUTPUT 1(8) FLEXLOGIC 01 to 20:** The twenty (20) messages shown in the table below are the parameters of the FlexLogic™ equation for output 1(8) as described in the introduction to FlexLogic™.



NOTE

The relays can also be energized from individual protection elements.

Table 5–13: Output relay default FlexLogic™

FlexLogic™ gate	Output relay number					
	1 to 3	4	5	6	7	8
01	Percent Diff OP	Volts/Hertz 1 OP	W1 THD Level OP	Underfreq 1 OP	Underfreq 2 OP	Freq Decay 3 OP
02	Inst Diff OP	Volts/Hertz 2 OP	W2 THD Level OP	Freq Decay R1 OP	Freq Decay R2 OP	END
03	Any W1 OC OP	OR (2 inputs)	Xfmr Overload OP	OR (2 inputs)	OR (2 inputs)	END
04	Any W2 OC OP	END	5th HarmLevel OP	END	END	END
05	OR (4 inputs)	END	OR (4 inputs)	END	END	END
06 to 20	END	END	END	END	END	END

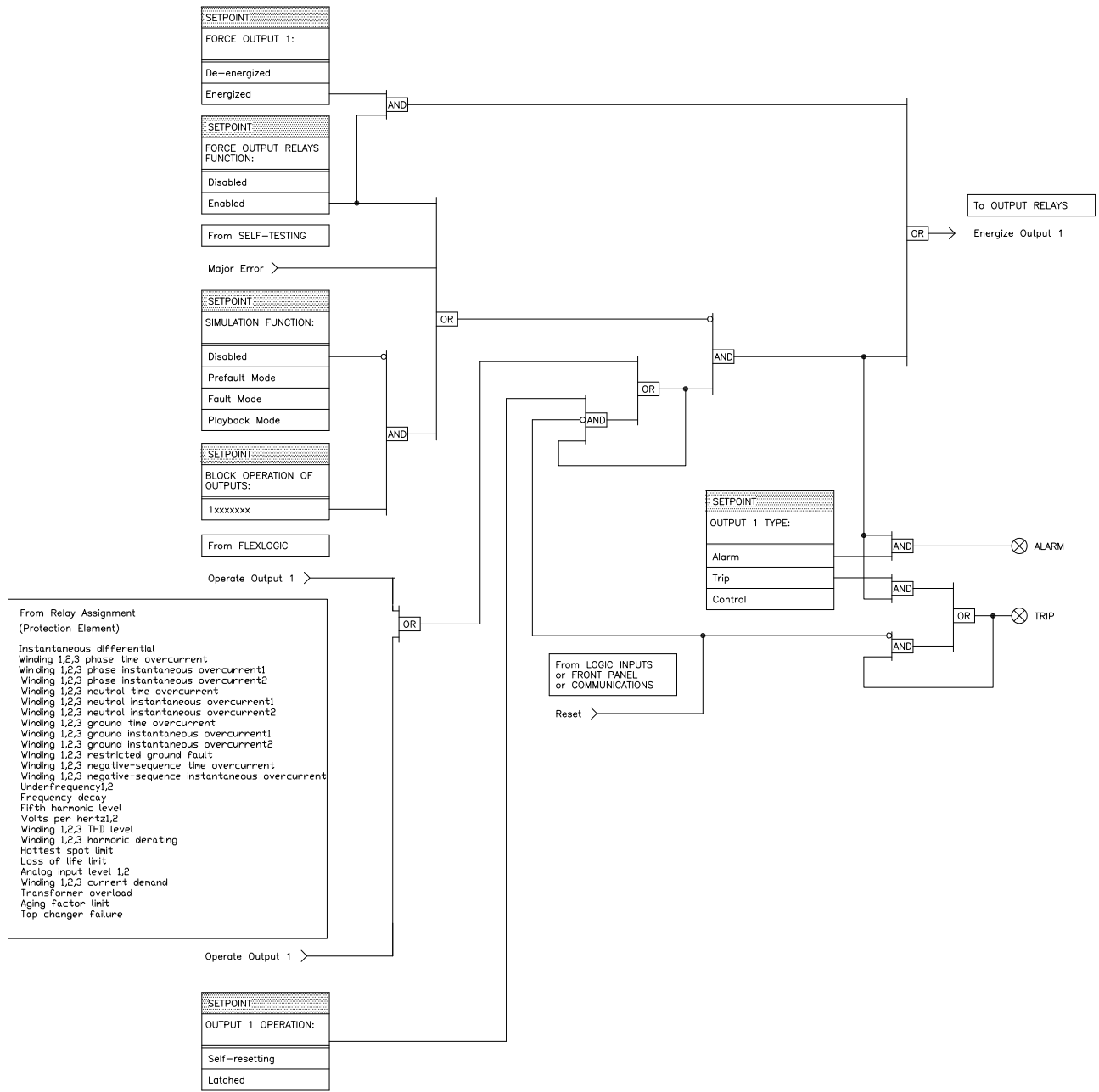

same for OUTPUTS 2 to 8

FIGURE 5-49: Output relays scheme logic

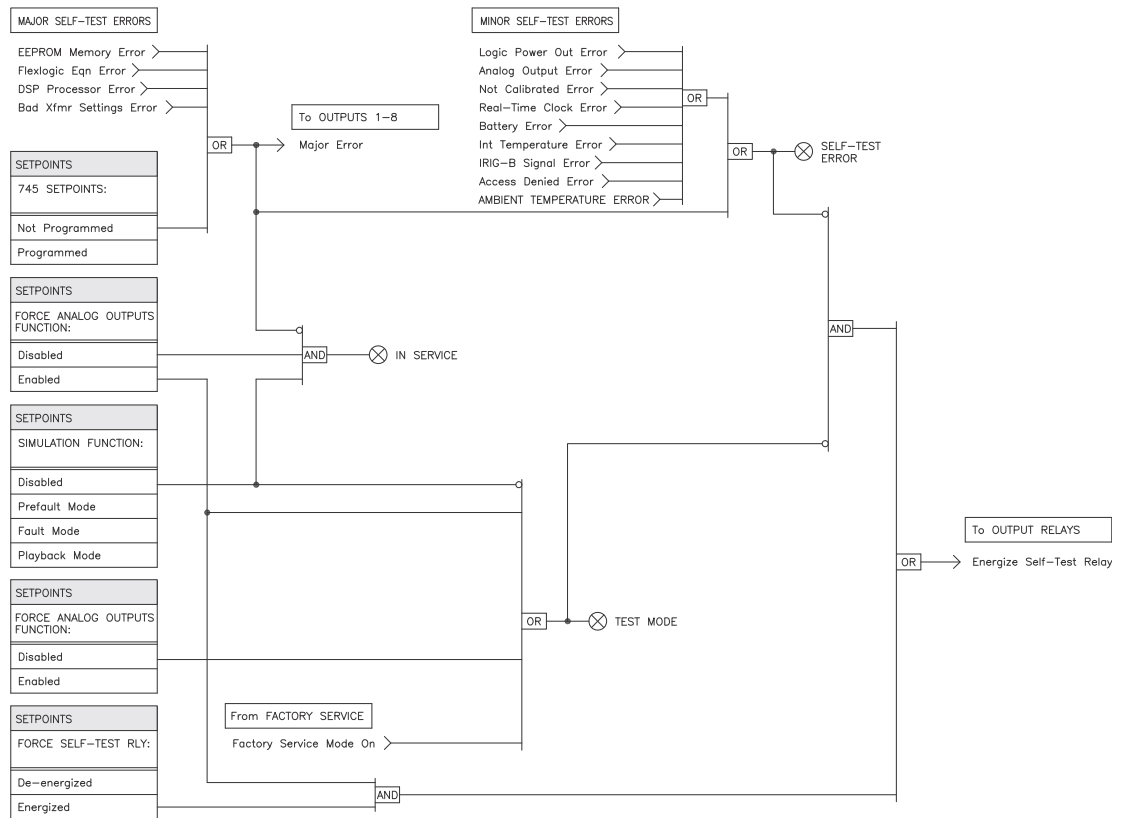
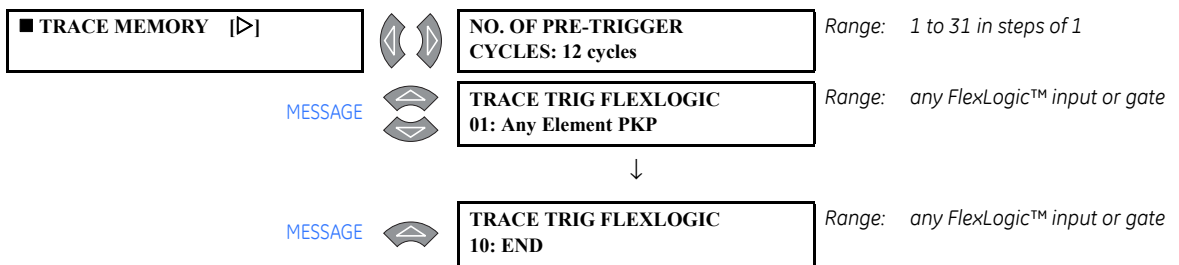

FIGURE 5-50: Self-test relays scheme logic

5.7.6 Trace Memory

PATH: SETPOINTS ▾ S5 OUTPUTS ▾ TRACE MEMORY



Trace memory is the oscillography feature of the 745. All system inputs are synchronously digitized at a sampling rate of 64 times per power cycle. Upon occurrence of a user-defined trigger condition, 32 cycles of oscillography waveforms are captured into trace memory. The trigger condition is defined by a FlexLogic™ equation, and the number of pre-trigger cycles of data captured is programmable.

This section contains the settings (including the FlexLogic™ equation) to configure trace memory triggering.

- **NO. OF PRE-TRIGGER CYCLES:** Enter the number of cycles of data, of the 32 cycles of waveform data to be captured, that are to be pre-trigger information.

- **TRACE TRIG FLEXLOGIC 01 to 10:** The following 10 messages are the parameters of the FlexLogic™ equation for trace memory triggering as described in *Introduction to FlexLogic™* on page 5–99.

The trace memory default FlexLogic™ is as follows: **TRACE TRIG FLEXLOGIC 01** is “Any Element PKP” and **TRACE TRIG FLEXLOGIC 02 to 12** are “END”.

5.7.7 Virtual Outputs

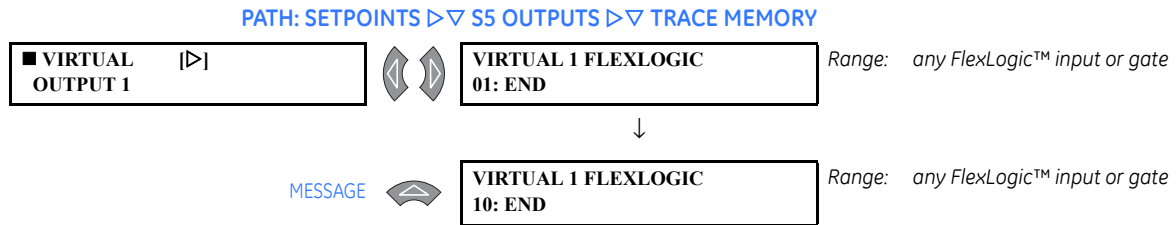

Virtual outputs are FlexLogic™ equations whose output (or result) can be used as inputs to other equations. The 745 has five (5) virtual outputs. One application of these outputs may be to contain a block of logic that is repeated for more than one output.

This section contains the FlexLogic™ equations to configure virtual outputs 1 to 5. The setpoints describe the parameters of the FlexLogic™ equation for virtual output 1(5) as described in *Introduction to FlexLogic™* on page 5–99.

5.7.8 Timers

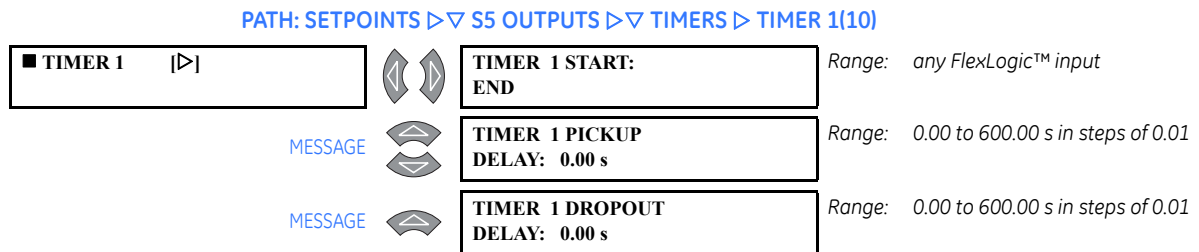

Protection and monitoring elements already have their own programmable delay timers, where they are required. For additional flexibility, ten (10) independent timers are available for implementing custom schemes where timers are not available. For example, a pickup delay timer may be required on a logic input; or, a single delay timer may be required on the output of a block of logic.

- **TIMER 1(10) START:** Select the FlexLogic™ entry which, when operated or asserted, will start timer 1(10).
- **TIMER 1(10) PICKUP DELAY:** Enter the delay time during which the start condition for timer 1(10) must remain operated or asserted, before the timer will operate.
- **TIMER 1(10) DROPOUT DELAY:** Enter the delay time after which the start condition for timer 1(10) must remain not operated or not asserted, before the timer will stop operating.

5.8 S6 Testing

5.8.1 Description

The 745 provides various diagnostic tools to verify the relay functionality. The normal function of all output contacts can be overridden and forced to be energized or de-energized. Analog outputs may be forced to any level of their output range. The simulation feature allows system parameters (magnitudes and angles) to be entered as setpoints and made to generate fault conditions without the necessity of any system connections. In addition, 32 cycles of sampled current/voltage waveform data (in IEEE COMTRADE file format) can be loaded and “played back” to test the response of the 745 under any (previously recorded) system disturbance.

5.8.2 Output Relays

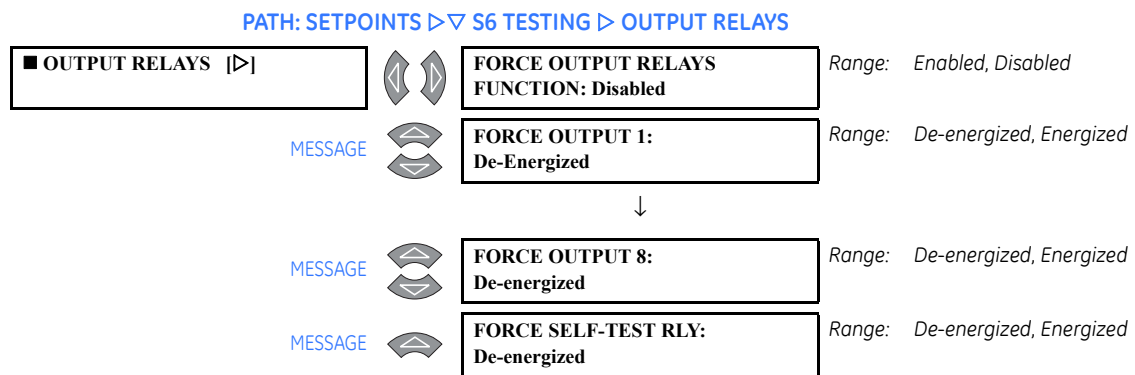

The 745 has the ability to override the normal function of all outputs, forcing each to energize and de-energize for testing. Enabling this feature turns the In Service LED off and the Test Mode LED on. Refer to FIGURE 5-49: *Output relays scheme logic* on page 5-104 for the output relay scheme logic.

- **FORCE OUTPUT RELAYS FUNCTION:** Select “Enabled” to enable the output relay testing feature and override normal output relay operation. This setpoint is defaulted to “Disabled” at power on.
- **FORCE OUTPUT 1 to 8:** Select “Energized” to force output 1(8) to the energized state or “De-energized” to force output 1(8) to the de-energized state. This setpoint is only operational when output relay testing is enabled.
- **FORCE SELF-TEST RLY:** Select “Energized” to force the self-test relay to the energized state and “De-energized” to force to the de-energized state. This setpoint is only operational while the output relay testing feature is enabled.

5.8.3 Analog Outputs

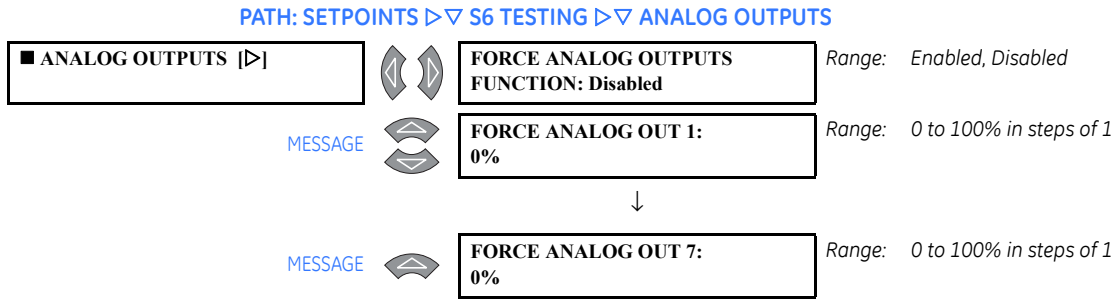

The 745 has the ability to override the normal function of analog transducer outputs, forcing each to any level of its output range. Enabling this feature turns the Test Mode LED on and de-energize the self-test relay.

- **FORCE ANALOG OUTPUT FUNCTION:** Select “Enabled” to enable the analog output testing and override the analog output normal operation. This setpoint defaults to “Disabled” at power on.
- **FORCE ANALOG OUT 1(7):** Enter the percentage of the DC mA output range of analog output 1(7). For example, if the analog output range has been programmed to 4 to 20 mA, entering 100% outputs 20 mA, 0% outputs 4 mA, and 50% outputs 12 mA. This setpoint is only operational if analog output testing is enabled.

5.8.4 Simulation

5.8.4.1 Main Menu

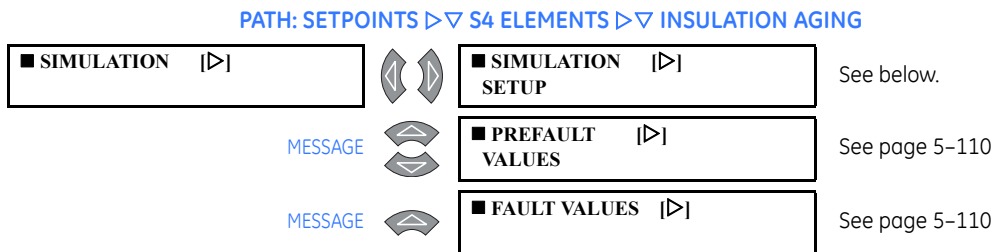

5.8.4.2 Simulation Setup

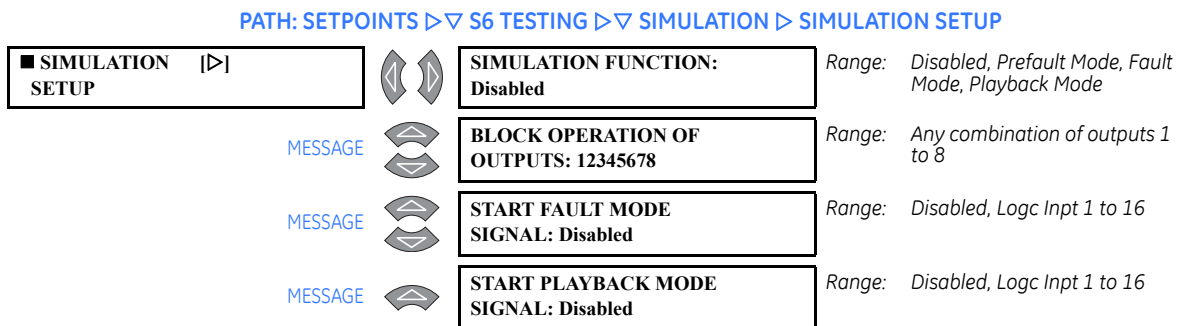

The simulation feature allows testing of the functionality of the relay in response to programmed conditions, without the need of external AC voltage and current inputs. System parameters such as currents and voltages, phase angles and system frequency

are entered as setpoints. When placed in simulation mode, the relay suspends reading actual AC inputs and generates samples to represent the programmed phasors. These samples are used in all calculations and protection logic. Enabling this feature will turn off the In Service LED, turn on the Test Mode LED, and de-energize the self-test relay.



When in simulation mode, protection features do not operate based on actual system inputs. If simulation mode is used for field testing on equipment, other means of protection must be provided by the operator.

- **SIMULATION FUNCTION:** Select the simulation mode required. Select “Disabled” to return the 745 to normal operation. The following table details the simulation function modes.
 - “Prefault Mode”: Select prefault mode to simulate the normal operating condition of a transformer. In this mode, the normal inputs are replaced with sample values generated based on the programmed prefault values. Phase currents are balanced (i.e. equal in magnitude and 120° apart), and the phase lag between windings is that which would result under normal conditions for the transformer type selected. The magnitude of phase currents for each winding are set to the values programmed in [S6 TESTING ▷ SIMULATION ▷ PREFault VALUES ▷ W1\(3\) PHASE ABC CURRENT MAGNITUDE](#). The magnitude of the voltage is set to the value programmed in [S6 TESTING ▷ SIMULATION ▷ PREFault VALUES ▷ VOLTAGE INPUT MAGNITUDE](#). The frequency is set to the value programmed in [S2 SYSTEM SETUP ▷ TRANSFORMER ▷ NOMINAL FREQUENCY](#).
 - “Fault Mode”: Select fault mode to simulate the faulted operating condition of a transformer. In this mode, the normal inputs are replaced with sample values generated based on the programmed fault values. The magnitude and angle of each phase current and ground current of the available windings, the magnitude and angle of the voltage input, and system frequency are set to the values programmed under [S6 TESTING ▷ SIMULATION ▷ FAULT VALUES](#).
A logic input, programmed to the “Simulate Fault” function, can be used to trigger the transition from the “Prefault Mode” to the “Fault Mode”, allowing the measurement of element operating times.
 - “Playback Mode”: Select playback mode to play back a sampled waveform data file which has been pre-loaded into the relay. In this mode, the normal inputs are replaced with 32 cycles of waveform samples downloaded into the 745 by the EnerVista 745 Setup software (from an oscillography data file in the IEEE COMTRADE file format).
A logic input, programmed to the “Simulate Playback” function, can be used to trigger the transition from the “Prefault Mode” to the “Playback Mode”, allowing the measurement of element operating times.
- **BLOCK OPERATION OF OUTPUTS:** Select the output relays which must be blocked from operating while in simulation mode. An operator can use the simulation feature to provide a complete functional test of the protection features, except for the measurement of external input values. As this feature may be used for on site testing, provision is made (with this setpoint) to block the operation of output relays during this testing, to prevent the operation of other equipment. Note that the default setting blocks the operation of all output relays.
- **START FAULT MODE SIGNAL:** Select any logic input which, when asserted, initiates fault mode simulation. This signal has an effect only if the 745 is initially in prefault mode.

- **START PLAYBACK MODE SIGNAL:** Select any logic input which, when asserted, initiates playback mode simulation. This signal has an effect only if the 745 is initially in prefault mode.

5.8.4.3 Prefault Values

PATH: SETPOINTS ▾ ▾ S6 TESTING ▾ ▾ SIMULATION ▾ ▾ PREFALT VALUES















<div style="border: 1px solid black; padding: 5px;"> ■ PREFALT VALUES ▶ </div>			<div style="border: 1px solid black; padding: 5px;"> W1 PHASE ABC CURRENT MAGNITUDE: 1.0 x CT </div>	Range: 0.0 to 40.0 x CT in steps of 0.1
	MESSAGE		<div style="border: 1px solid black; padding: 5px;"> W2 PHASE ABC CURRENT MAGNITUDE: 1.0 x CT </div>	Range: 0.0 to 40.0 x CT in steps of 0.1
	MESSAGE		<div style="border: 1px solid black; padding: 5px;"> W3 PHASE ABC CURRENT MAGNITUDE: 1.0 x CT </div>	Range: 0.0 to 40.0 x CT in steps of 0.1
	MESSAGE		<div style="border: 1px solid black; padding: 5px;"> VOLTAGE INPUT MAGNITUDE: 1.0 x VT </div>	Range: 0.0 to 2.0 x VT in steps of 0.1

- **W1 to W3 PHASE ABC CURRENT MAGNITUDE:** Enter the winding 1(3) phase current magnitude (in terms of the winding full load current) while in prefault mode.
- **VOLTAGE INPUT MAGNITUDE:** Enter the voltage magnitude (in terms of the nominal VT secondary voltage) while in prefault mode.

5.8.4.4 Fault Values

PATH: SETPOINTS ▾ ▾ S6 TESTING ▾ ▾ SIMULATION ▾ ▾ FAULT VALUES

<div style="border: 1px solid black; padding: 5px;"> ■ FAULT VALUES ▶ </div>			<div style="border: 1px solid black; padding: 5px;"> W1 PHASE A CURRENT MAGNITUDE: 1.0 x CT </div>	Range: 0.0 to 40.0 x CT in steps of 0.1
	MESSAGE		<div style="border: 1px solid black; padding: 5px;"> W1 PHASE A CURRENT ANGLE: 0° </div>	Range: 0 to 359° in steps of 1
	MESSAGE		<div style="border: 1px solid black; padding: 5px;"> W1 PHASE B CURRENT MAGNITUDE: 1.0 x CT </div>	Range: 0.0 to 40.0 x CT in steps of 0.1
	MESSAGE		<div style="border: 1px solid black; padding: 5px;"> W1 PHASE B CURRENT ANGLE: 0° </div>	Range: 0 to 359° in steps of 1
	MESSAGE		<div style="border: 1px solid black; padding: 5px;"> W1 PHASE C CURRENT MAGNITUDE: 1.0 x CT </div>	Range: 0.0 to 40.0 x CT in steps of 0.1
	MESSAGE		<div style="border: 1px solid black; padding: 5px;"> W1 PHASE C CURRENT ANGLE: 0° </div>	Range: 0 to 359° in steps of 1
	MESSAGE		<div style="border: 1px solid black; padding: 5px;"> W1 GROUND CURRENT MAGNITUDE: 0.0 x CT </div>	Range: 0.0 to 40.0 x CT in steps of 0.1
	MESSAGE		<div style="border: 1px solid black; padding: 5px;"> W1 GROUND CURRENT ANGLE: 0° </div>	Range: 0 to 359° in steps of 1
	MESSAGE		<div style="border: 1px solid black; padding: 5px;"> W2 PHASE A CURRENT MAGNITUDE: 1.0 x CT </div>	Range: 0.0 to 40.0 x CT in steps of 0.1
	MESSAGE		<div style="border: 1px solid black; padding: 5px;"> W2 PHASE A CURRENT ANGLE: 0° </div>	Range: 0 to 359° in steps of 1
	MESSAGE		<div style="border: 1px solid black; padding: 5px;"> W2 PHASE B CURRENT MAGNITUDE: 1.0 x CT </div>	Range: 0.0 to 40.0 x CT in steps of 0.1
	MESSAGE		<div style="border: 1px solid black; padding: 5px;"> W2 PHASE B CURRENT ANGLE: 0° </div>	Range: 0 to 359° in steps of 1

MESSAGE		W2 PHASE C CURRENT MAGNITUDE: 1.0 x CT	Range: 0.0 to 40.0 x CT in steps of 0.1
MESSAGE		W2 PHASE C CURRENT ANGLE: 0°	Range: 0 to 359° in steps of 1
MESSAGE		W2 GROUND CURRENT MAGNITUDE: 0.0 x CT	Range: 0.0 to 40.0 x CT in steps of 0.1
MESSAGE		W2 GROUND CURRENT ANGLE: 0°	Range: 0 to 359° in steps of 1
MESSAGE		W3 PHASE A CURRENT MAGNITUDE: 1.0 x CT	Range: 0.0 to 40.0 x CT in steps of 0.1
MESSAGE		W3 PHASE A CURRENT ANGLE: 0°	Range: 0 to 359° in steps of 1
MESSAGE		W3 PHASE B CURRENT MAGNITUDE: 1.0 x CT	Range: 0.0 to 40.0 x CT in steps of 0.1
MESSAGE		W3 PHASE B CURRENT ANGLE: 0°	Range: 0 to 359° in steps of 1
MESSAGE		W3 PHASE C CURRENT MAGNITUDE: 1.0 x CT	Range: 0.0 to 40.0 x CT in steps of 0.1
MESSAGE		W3 PHASE C CURRENT ANGLE: 0°	Range: 0 to 359° in steps of 1
MESSAGE		W3 GROUND CURRENT MAGNITUDE: 0.0 x CT	Range: 0.0 to 40.0 x CT in steps of 0.1
MESSAGE		W3 GROUND CURRENT ANGLE: 0°	Range: 0 to 359° in steps of 1
MESSAGE		VOLTAGE INPUT MAGNITUDE: 1.0 x VT	Range: 0.0 to 2.0 x VT in steps of 0.1
MESSAGE		VOLTAGE INPUT ANGLE: 0° Lag	Range: 0 to 359° Lag in steps of 1
MESSAGE		FREQUENCY: 60.00 Hz	Range: 45.00 to 60.00 Hz in steps of 0.01

- **W1(W3) PHASE A(C) CURRENT MAGNITUDE:** Enter the winding 1(3) phase A(C) current magnitude (in terms of the winding full load current) while in fault mode.
- **W1(3) PHASE A(C) CURRENT ANGLE:** Enter the winding 1(3) phase A(C) current angle (with respect to the winding 1 phase A current phasor) while in fault mode. Note that the winding 1 phase A current angle cannot be edited and is used as a reference for the other phase angles.
- **W1(3) GROUND CURRENT MAGNITUDE:** Enter the winding 1(3) ground current magnitude (in terms of the winding FLC) while in fault mode. Note that ground refers to the measured CT current in the connection between transformer neutral and ground. As such, this message only appears for wye or zig-zag connected windings.
- **W1(3) GROUND CURRENT ANGLE:** Enter the winding 1(3) ground current angle (with respect to the winding 1 phase A current phasor). This message only appears for wye or zig-zag connected windings.

5.8.5 Factory Service

PATH: SETPOINTS ▷ ▾ S6 TESTING ▷ ▾ SIMULATION ▷ ▾ FACTORY SERVICE

■ FACTORY SERVICE [▷]		ENTER FACTORY PASSCODE:	Range: <i>Restricted access for factory personnel only</i>
-----------------------	---	----------------------------	--

This section contains settings intended for factory use only, for calibration, testing, and diagnostics. The messages can only be accessed by entering a factory service passcode in the first message.



745 Transformer Protection System

Chapter 6: Actual values

6.1 Overview

6.1.1 Message Map

Measured values, event records and product information are actual values. Actual values may be accessed via any of the following methods:

- Front panel, using the keys and display.
- Front program port or rear Ethernet port and a portable computer running the EnerVista 745 Setup software supplied with the relay.
- Rear RS485/RS422 COM 1 port or RS485 COM 2 port with any system running user written software.

Any of these methods can be used to view the same information. A computer, however, makes viewing much more convenient, since more than one piece of information can be viewed at the same time.

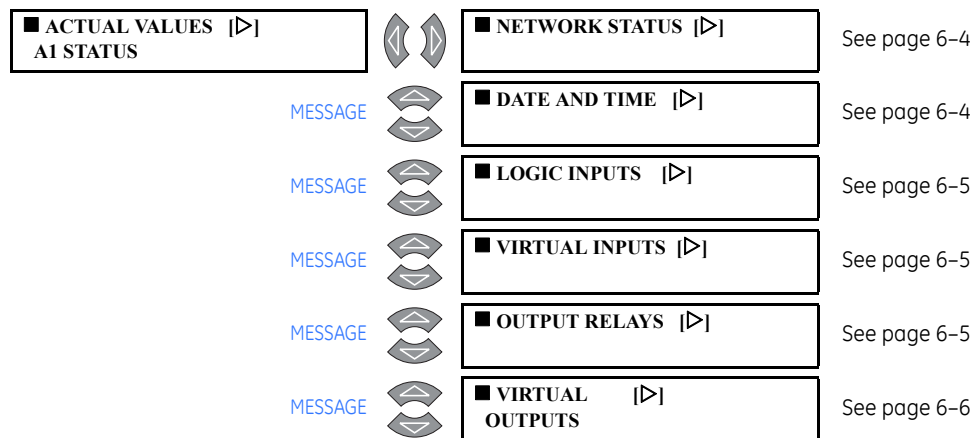

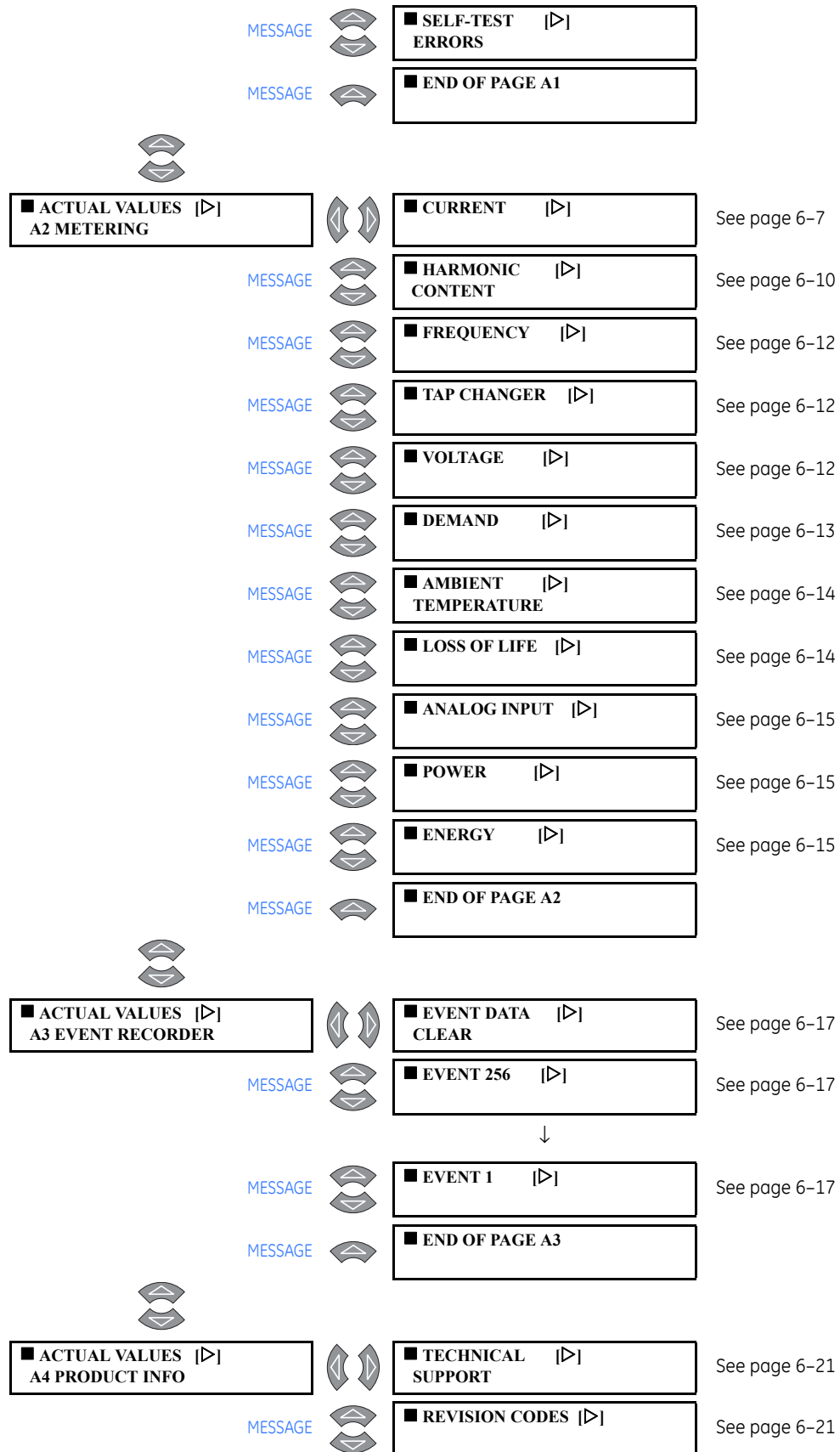

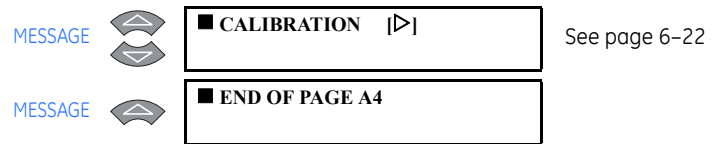

6.1.2 Description

Actual value messages are organized into logical groups, or pages, for easy reference. All actual value messages are illustrated and described in blocks throughout this chapter. A reference of all messages is also provided at the end of the chapter. All values shown in these message illustrations assume that no inputs (besides control power) are connected to the 745.

Some messages appear on the following pages with a gray background. This indicates that the message may not appear depending upon the configuration of the relay (as selected by setpoints) or the options installed in the relay during manufacture. For example, no display associated with winding 3 will ever appear if the relay is not configured for three-winding operation.

6.2 A1 Status

6.2.1 Network Status

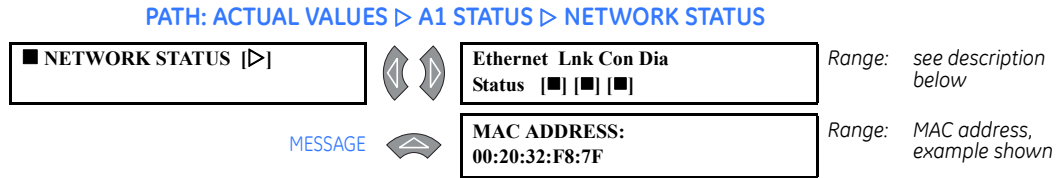

These actual values appear when the relay is ordered with the Ethernet (T) option.

The **ETHERNET STATUS** actual value message indicates the status of the Ethernet link, connection, and diagnostic via three indicators. The [■] symbol indicates on, and the [] symbol indicates off. There is also a blinking indication.

The box under **Lnk** column indicates the Ethernet link status. If it is on, the Ethernet port is connected to the network; if it is off, the port is disconnected. This indicator is normally on.

The box under the **Con** column indicates the connection status. If on, the Ethernet port is configured and ready to transmit and receive data. If blinking, the Ethernet port is either active (transmitting or receiving data) or indicating an error if the diagnostic status is also on or blinking.

The box under the **Dia** column indicates the diagnostic status. If it is on, then either a fatal Ethernet port error has occurred or there is a duplicate IP address on the network. If blinking, then there is a non-fatal network error. Off indicates no errors.

6.2.2 Date and Time

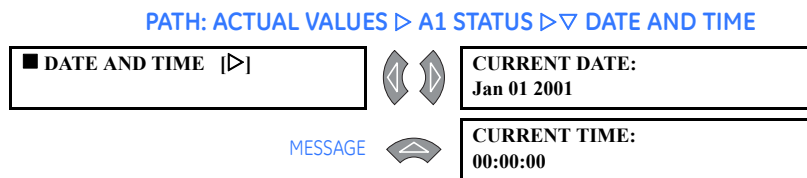

The current date and time are displayed here.

6.2.3 Logic Inputs

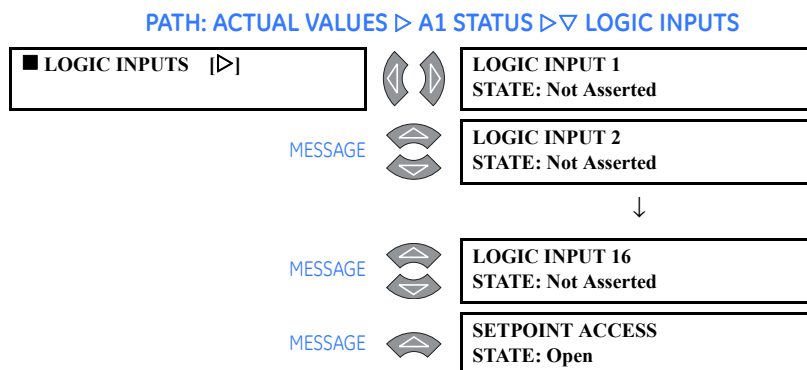

The states of logic inputs 1 through 16 and the setpoint access jumper are displayed here. Setpoints cannot be changed from the front panel when the **SETPOINT ACCESS STATE** is "Open".

6.2.4 Virtual Inputs

PATH: ACTUAL VALUES > A1 STATUS > VIRTUAL INPUTS

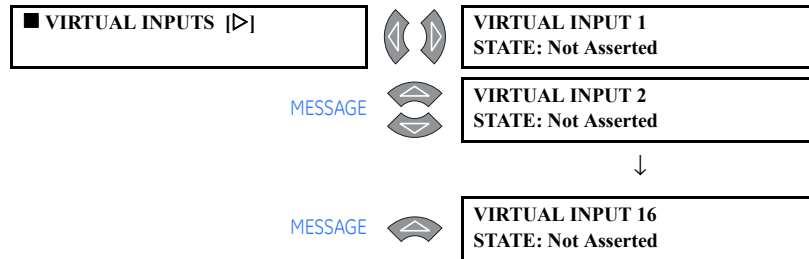

The states of virtual inputs 1 through 16 are displayed here.

6.2.5 Output Relays

PATH: ACTUAL VALUES > A1 STATUS > OUTPUT RELAYS

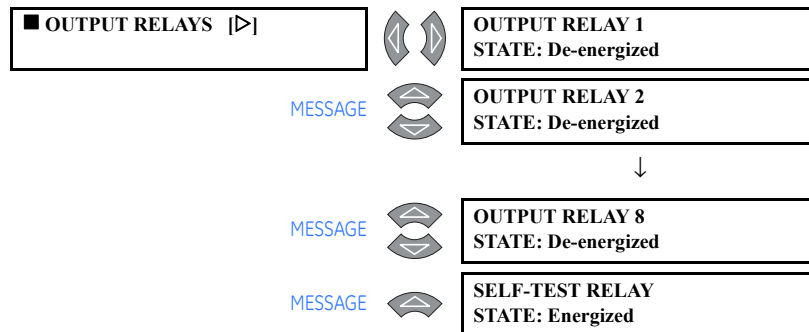

The states of output relays 1 through 8 and the self-test relay are displayed here.

6.2.6 Virtual Outputs

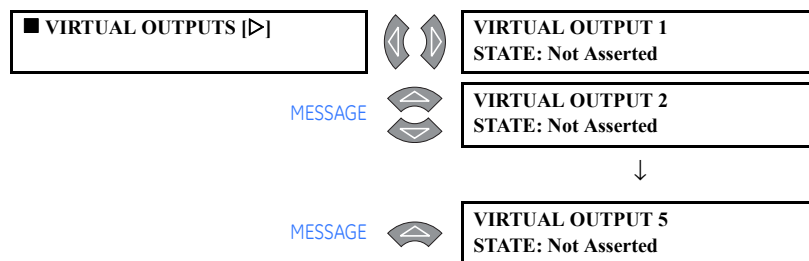

PATH: ACTUAL VALUES > A1 STATUS > VIRTUAL OUTPUTS



The states of virtual outputs 1 through 5 are displayed here.

6.2.7 Self-test Errors

PATH: ACTUAL VALUES > A1 STATUS > SELF-TEST ERRORS

■ SELF-TEST ERRORS ▷		FLEXLOGIC EQN ERROR: None
MESSAGE 		BAD SETTINGS ERROR: None

The **FLEXLOGIC EQN ERROR** value displays the source of the error occurring in a FlexLogic™ equation. The **BAD SETTINGS ERROR** value displays the cause of a bad setting made while assigning setpoint values.

6.3 A2 Metering

6.3.1 Current

6.3.1.1 Main Menu

PATH: ACTUAL VALUES ▾ ▾ A2 METERING ▾ CURRENT

■ CURRENT ▷		■ W1 CURRENT ▷	See below.
MESSAGE		■ W2 CURRENT ▷	See below.
MESSAGE		■ W3 CURRENT ▷	See below.
MESSAGE		■ POSITIVE SEQUENCE ▷	See page 6-8
MESSAGE		■ NEGATIVE SEQUENCE ▷	See page 6-8
MESSAGE		■ ZERO SEQUENCE ▷	See page 6-9
MESSAGE		■ DIFFERENTIAL ▷	See page 6-9
MESSAGE		■ RESTRAINT ▷	See page 6-9
MESSAGE		■ GROUND DIFFERENTIAL ▷	See page 6-10

For each monitored winding, the fundamental frequency magnitude and phase angle of phase A, B, C and ground currents are recalculated every half-cycle for use in differential and overcurrent protection. From these values, neutral, positive, negative and zero-sequence as well as differential, restraint and ground differential currents are calculated. These are displayed and updated approximately twice a second for readability.

6.3.1.2 Winding Currents

PATH: ACTUAL VALUES ▾ ▾ A2 METERING ▾ CURRENT ▾ W1(3) CURRENT

<p>■ W1 CURRENT ▷ </p>		<p>W1 PHASE A CURRENT: 0 A at 0° Lag</p>
MESSAGE		<p>W1 PHASE B CURRENT: 0 A at 0° Lag</p>
MESSAGE		<p>W1 PHASE C CURRENT: 0 A at 0° Lag</p>
MESSAGE		<p>W1 NEUTRAL CURRENT: 0 A at 0° Lag</p>
MESSAGE		<p>W1 GROUND CURRENT: 0 A at 0° Lag</p>
MESSAGE		<p>WINDING 1 LOADING: 0% of rated load</p>
MESSAGE		<p>W1 AVERAGE PHASE CURRENT: 0 A</p>

The fundamental frequency current magnitudes for winding 1 phases A, B, and C, neutral, and ground are shown. The current angle for phase A is always set to 0° as it is used as reference for all other currents, both measured and derived. The maximum specified load and average phase current are also shown for the specified winding.

6.3.1.3 Positive-sequence Current

PATH: ACTUAL VALUES ▾ ▾ A2 METERING ▾ CURRENT ▾ POSITIVE SEQUENCE

<p>■ POSITIVE SEQUENCE ▷ </p>		<p>W1 POS SEQ CURRENT: 0 A at 0° Lag</p>
MESSAGE		<p>W2 POS SEQ CURRENT: 0 A at 0° Lag</p>
MESSAGE		<p>W3 POS SEQ CURRENT: 0 A at 0° Lag</p>



All positive-, negative-, and zero- sequence component phase angles are referenced to the winding 1 phase A current

The positive-sequence current magnitudes and phase values for windings 1, 2, and 3 are shown here.

6.3.1.4 Negative-sequence Current



PATH: ACTUAL VALUES ▾ ▾ A2 METERING ▾ CURRENT ▾ NEGATIVE SEQUENCE

<p>■ NEGATIVE SEQUENCE ▷ </p>		<p>W1 NEG SEQ CURRENT: 0 A at 0° Lag</p>
MESSAGE		<p>W2 NEG SEQ CURRENT: 0 A at 0° Lag</p>
MESSAGE		<p>W3 NEG SEQ CURRENT: 0 A at 0° Lag</p>

The negative-sequence current magnitudes and phase values for windings 1, 2, and 3 are shown here.

6.3.1.5 Zero-sequence Current







PATH: ACTUAL VALUES ▾ ▾ A2 METERING ▾ CURRENT ▾ ▾ ZERO SEQUENCE

ZERO SEQUENCE ▷		W1 ZERO SEQ CURRENT: 0 A at 0° Lag
	MESSAGE 	W2 ZERO SEQ CURRENT: 0 A at 0° Lag
	MESSAGE 	W3 ZERO SEQ CURRENT: 0 A at 0° Lag

The zero-sequence current magnitudes and phase values for windings 1, 2, and 3 are shown here.

6.3.1.6 Differential Current



PATH: ACTUAL VALUES ▾ ▾ A2 METERING ▾ CURRENT ▾ ▾ DIFFERENTIAL

DIFFERENTIAL ▷		PHASE A DIFFERENTIAL CURRENT: 0.00 x CT
	MESSAGE 	PHASE A DIFFERENTIAL ANGLE: 0° Lag
	MESSAGE 	PHASE B DIFFERENTIAL CURRENT: 0.00 x CT
	MESSAGE 	PHASE B DIFFERENTIAL ANGLE: 0° Lag
	MESSAGE 	PHASE C DIFFERENTIAL CURRENT: 0.00 x CT
	MESSAGE 	PHASE C DIFFERENTIAL ANGLE: 0° Lag

The differential current magnitudes and angles for phases A, B, and C are shown. The differential current phase angles are referenced to winding 1 phase A current.

6.3.1.7 Restraint Current

PATH: ACTUAL VALUES ▾ ▾ A2 METERING ▾ CURRENT ▾ ▾ RESTRAINT

RESTRAINT ▷		PHASE A RESTRAINT CURRENT: 0.00 x CT
	MESSAGE 	PHASE B RESTRAINT CURRENT: 0.00 x CT
	MESSAGE 	PHASE C RESTRAINT CURRENT: 0.00 x CT

The restraint current magnitudes for phases A, B, and C are shown here.

6.3.1.8 Ground Differential Current

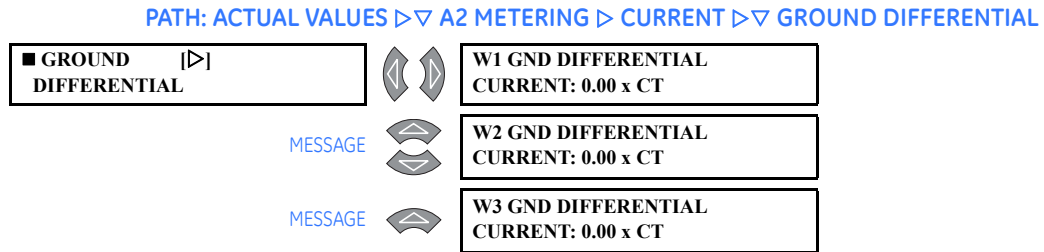

The ground differential current magnitudes for windings 1 through 3 are shown.

6.3.2 Harmonic Content

6.3.2.1 Main Menu

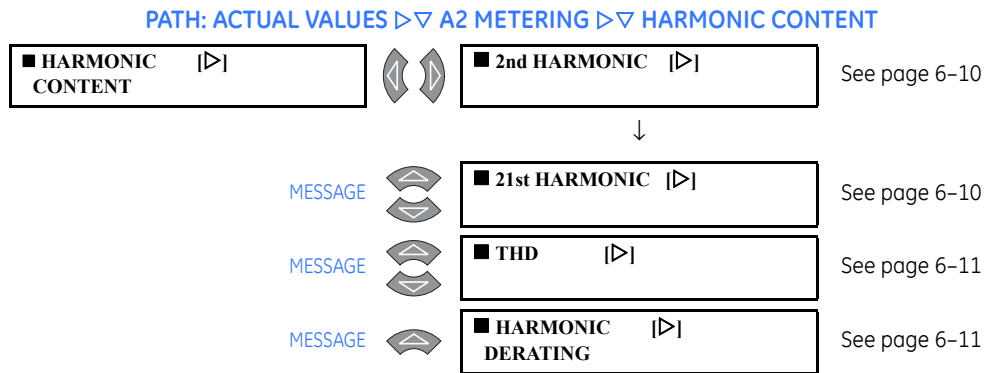

The 745 can determine the harmonic components of every current that it measures. This allows it to calculate total harmonic distortion (THD) as well as a harmonic derating factor that can be used to adjust phase time overcurrent protection to account for additional internal energy dissipation that arises from the presence of harmonic currents.

6.3.2.2 Harmonic Sub-components

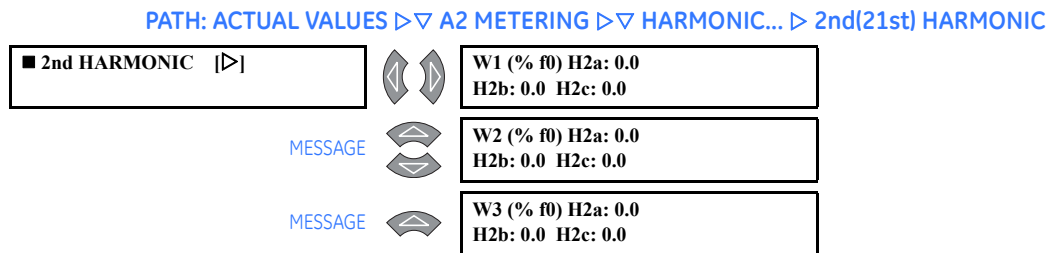

The 745 is capable of measuring harmonic components up to a frequency of 21 times nominal system frequency. An actual value is calculated for each phase of each monitored winding. The example above shows what is displayed in a typical case for harmonic components (in this case the second harmonic). Similar displays exist for all harmonics up to the 21st.

The second harmonic magnitude for each phase current of windings 1 through 3 are displayed. Values are expressed as a percentage of magnitude of the corresponding fundamental frequency component.

6.3.2.3 Total Harmonic Distortion (THD)

PATH: ACTUAL VALUES ▾ ▾ A2 METERING ▾ ▾ HARMONIC CONTENT ▾ ▾ THD

■ THD	▷		W1 THDa (2nd-21st): 0.0% fo
MESSAGE			W1 THDb (2nd-21st): 0.0% fo
MESSAGE			W1 THDc (2nd-21st): 0.0% fo
MESSAGE			W2 THDa (2nd-21st): 0.0% fo
MESSAGE			W2 THDb (2nd-21st): 0.0% fo
MESSAGE			W2 THDc (2nd-21st): 0.0% fo
MESSAGE			W3 THDa (2nd-21st): 0.0% fo
MESSAGE			W3 THDb (2nd-21st): 0.0% fo
MESSAGE			W3 THDc (2nd-21st): 0.0% fo

THD is calculated and displayed. Every THD value is calculated as the ratio of the RMS value of the sum of the squared individual harmonic amplitudes to the RMS value of the fundamental frequency. The calculations are based on IEEE standard 519-1986.

The actual values messages display the total harmonic distortion for phase A, B, and C currents for windings 1 through 3, expressed as a percentage of the fundamental frequency component. The numbers in parentheses indicate the programmed frequency band (in terms of harmonic number) over which THD is being calculated.

6.3.2.4 Harmonic Derating Factor

PATH: ACTUAL VALUES ▾ ▾ A2 METERING ▾ ▾ HARMONIC... ▾ ▾ HARMONIC DERATING

■ HARMONIC DERATING	▷		W1 HARMONIC DERATING FACTOR: 1.00
MESSAGE			W2 HARMONIC DERATING FACTOR: 1.00
MESSAGE			W3 HARMONIC DERATING FACTOR: 1.00



These actual values are shown only if the harmonic derating function is enabled.

The harmonic derating factor for each of the windings shows the effect of non-sinusoidal load currents on power transformer’s rated full load current. The calculations are based on ANSI/IEEE standard C57.110-1986. The actual values messages display the harmonic derating factor for windings 1 through 3.

6.3.3 Frequency

PATH: ACTUAL VALUES ▾ ▾ A2 METERING ▾ ▾ FREQUENCY

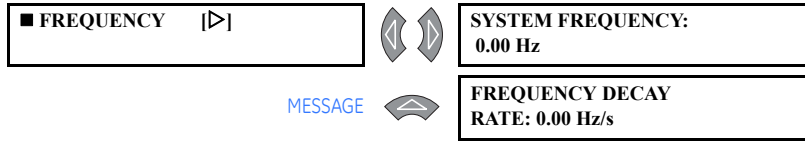

The **SYSTEM FREQUENCY** is calculated from the voltage input provided that voltage sensing is enabled and the injected voltage is above 50% of VT. If these criteria are not satisfied, then it is determined from winding 1 phase A current provided that it is above $0.05 \times CT$. If frequency still cannot be calculated, “0.00 Hz” is displayed, though the sampling rate is then set for the **S2 SYSTEM SETUP ▾ TRANSFORMER ▾ NOMINAL FREQUENCY** setpoint. The **FREQUENCY DECAY RATE** can only be calculated if system frequency can be calculated.

6.3.4 Tap Changer

PATH: ACTUAL VALUES ▾ A2 METERING ▾ ▾ TAP CHANGER



This message displays the actual tap position. If tap position sensing is disabled, “n/a” will be displayed.

6.3.5 Voltage

PATH: ACTUAL VALUES ▾ ▾ A2 METERING ▾ ▾ VOLTAGE

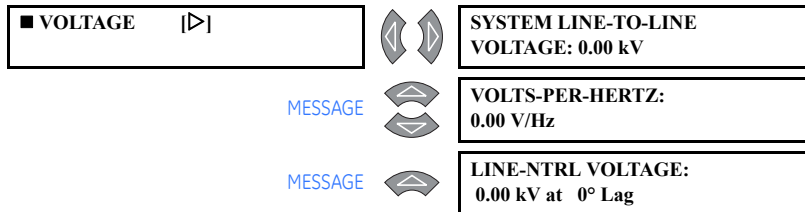





For phase-to-neutral input voltages, the **SYSTEM LINE-TO-LINE VOLTAGE** displays its line-to-line equivalent.

6.3.6 Demand

6.3.6.1 Main Menu



PATH: ACTUAL VALUES ▾ ▾ A2 METERING ▾ ▾ DEMAND

<div style="border: 1px solid black; padding: 2px;"> <p>■ DEMAND ▷ </p> </div>		<div style="border: 1px solid black; padding: 2px;"> <p>■ DEMAND DATA ▷ CLEAR</p> </div>	See page 6-13
MESSAGE		<div style="border: 1px solid black; padding: 2px;"> <p>■ W1 CURRENT ▷ DEMAND</p> </div>	See page 6-14
MESSAGE		<div style="border: 1px solid black; padding: 2px;"> <p>■ W2 CURRENT ▷ DEMAND</p> </div>	See page 6-14
MESSAGE		<div style="border: 1px solid black; padding: 2px;"> <p>■ W3 CURRENT ▷ DEMAND</p> </div>	See page 6-14

Current demand is measured on each phase of each monitored winding. These parameters can be monitored to reduce supplier demand penalties or for statistical metering purposes. The calculated demand is based on the [S2 SYSTEM SETUP ▾ ▾ DEMAND METERING ▾ CURRENT DEMAND METER TYPE](#) setpoint value. For each quantity, the 745 displays the demand over the most recent demand time interval, the maximum demand since the last date that the demand data was reset, and the time and date stamp of this maximum value.

6.3.6.2 Demand Data Clear

PATH: ACTUAL VALUES ▾ ▾ A2 METERING ▾ ▾ DEMAND ▾ DEMAND DATA CLEAR

<div style="border: 1px solid black; padding: 2px;"> <p>■ DEMAND DATA ▷ CLEAR</p> </div>		<div style="border: 1px solid black; padding: 2px;"> <p>CLEAR MAX DEMAND DATA: No</p> </div>
MESSAGE		<div style="border: 1px solid black; padding: 2px;"> <p>DATE OF LAST CLEAR: Jan 01 1996</p> </div>
MESSAGE		<div style="border: 1px solid black; padding: 2px;"> <p>TIME OF LAST CLEAR: 00:00:00.000</p> </div>

To clear all maximum demand data, set [CLEAR MAX DEMAND DATA](#) to “Yes”. The last time that the demand data were cleared is also displayed. If the date has never been programmed, the default values shown above appear.

6.3.6.3 Current Demand

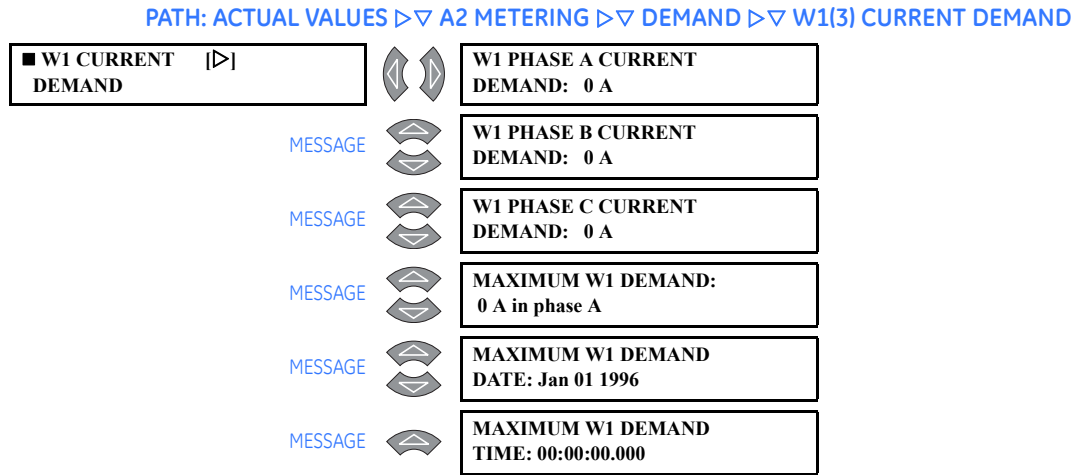

The current demand for winding 1 phases A through C are displayed in these messages. The maximum current demand, the phase in which it occurred, and the date and time it occurred are also shown. If the date has never been programmed, the default values shown above appear. These messages are repeated for windings 2 and 3.

6.3.7 Ambient Temperature



Ambient temperature is monitored via an RTD connected to the 745.

6.3.8 Loss of Life

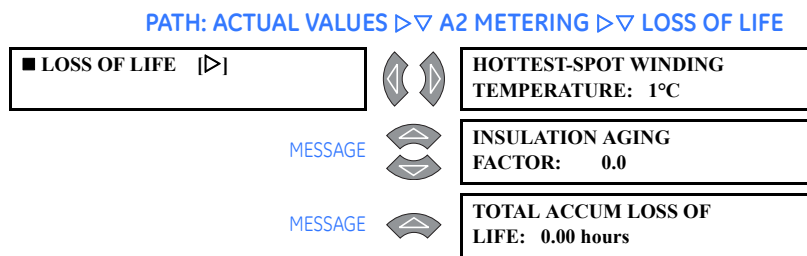

The **HOTTEST-SPOT WINDING TEMPERATURE** is calculated from the ambient temperature and the highest-load winding current. The **INSULATION AGING FACTOR** is calculated from the hottest-spot temperature. The **TOTAL ACCUM LOSS OF LIFE** value displays the total equivalent service hours of the transformer.

6.3.9 Analog Input

PATH: ACTUAL VALUES ▾ A2 METERING ▾ ANALOG INPUT



The 745 provides the ability to monitor any external quantity via an auxiliary current input called the Analog Input. The scaled value of the analog input is shown. In this message, the name programmed in [S2 SYSTEM SETUP ▾ ANALOG INPUT ▾ ANALOG INPUT NAME](#) is displayed instead of [ANALOG INPUT](#) (the factory default), and the units programmed in [S2 SYSTEM SETUP ▾ ANALOG INPUT ▾ ANALOG INPUT UNITS](#) are displayed instead of “μA” (which is the factory default).

6.3.10 Power

PATH: ACTUAL VALUES ▾ A2 METERING ▾ POWER w W1(3) POWER

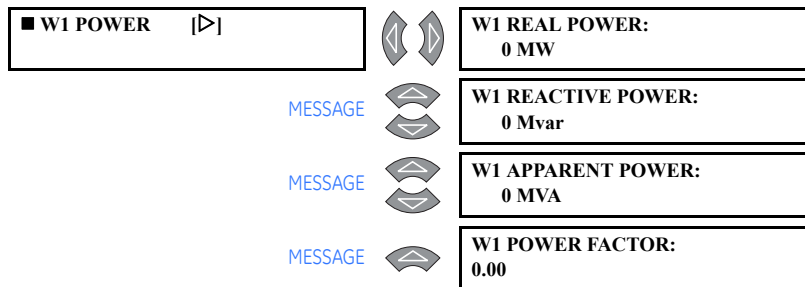

The 745 calculates and displays real, reactive, and apparent power as well as the power factor for all of the available windings providing that the voltage sensing is enabled. Power flowing into the power transformer is designated as source power and power flowing out of the transformer is designated as load power.

6.3.11 Energy

6.3.11.1 Main Menu

PATH: ACTUAL VALUES ▾ A2 METERING ▾ ENERGY

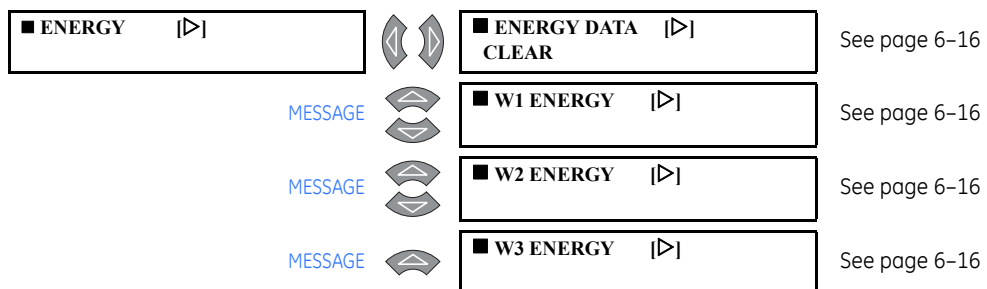

The 745 calculates and displays watthours and varhours for source and load currents for all available windings, providing that the voltage sensing is enabled.

6.3.11.2 Energy Data Clear

PATH: ACTUAL VALUES ▾ ▾ A2 METERING ▾ ▾ ENERGY ▾ ENERGY DATA CLEAR

■ ENERGY DATA CLEAR [▷]		CLEAR ENERGY DATA? No
		MESSAGE DATE OF LAST CLEAR: Jan 01 1996
		MESSAGE TIME OF LAST CLEAR: 00:00:00

To clear all energy data, set **CLEAR ENERGY DATA** to “Yes”. The last date and time that the energy data were cleared are also displayed. If the date has never been programmed, the default values shown above appear.

6.3.11.3 Windings 1 to 3 Energy

PATH: ACTUAL VALUES ▾ ▾ A2 metering ▾ ▾ ENERGY ▾ W1(3) ENERGY

■ W1 ENERGY [▷]		W1 SOURCE WATTHOURS: 0 MWh
		MESSAGE W1 LOAD WATTHOURS: 0 MWh
		MESSAGE W1 SOURCE VARHOURS: 0 Mvarh
		MESSAGE W1 LOAD VARHOURS: 0 Mvarh

The source and load watthours and varhours are displayed for winding 1. These messages are repeated for windings 2 and 3.

6.4 A3 Event Recorder

6.4.1 Event Data Clear

PATH: ACTUAL VALUES ▾ ▾ A3 EVENT RECORDER ▾ EVENT DATA CLEAR























■ EVENT DATA CLEAR [▷]			CLEAR EVENT DATA RECORDER? No
	MESSAGE		CLEAR EVENT RECORDER SIGNAL: Disabled
	MESSAGE		DATE OF LAST CLEAR: Jan 01 1996
	MESSAGE		TIME OF LAST CLEAR: 00:00:00.000
	MESSAGE		NO. OF EVENTS SINCE LAST CLEAR: 0

Enter "Yes" for the **CLEAR EVENT DATA RECORDER** to clear all event recorder data. The **CLEAR EVENT RECORDER SIGNAL** actual value assigns a logic input to be used for remote clearing of the event recorder. The last date and time the event data were cleared are also displayed. If the date has never been programmed, the default values shown above appear.

6.4.2 Event Records

PATH: ACTUAL VALUES ▾ ▾ A3 EVENT RECORDER ▾ EVENT 001(256)

■ EVENT 001 [▷]			EVENT DATE: Jan 01 2001
	MESSAGE		EVENT TIME: 00:00:00.000
	MESSAGE		EVENT CAUSE: On Control Power
	MESSAGE		W1 PHASE A CURRENT 0 A at 0° Lag
	MESSAGE		W1 PHASE B CURRENT 0 A at 0° Lag
	MESSAGE		W1 PHASE C CURRENT 0 A at 0° Lag
	MESSAGE		W1 GROUND CURRENT 0 A at 0° Lag
	MESSAGE		W1 (% fo) H2a: 0.0 H2b: 0.0 H2c: 0.0
	MESSAGE		W1 (% fo) H5a: 0.0 H5b: 0.0 H5c: 0.0
	MESSAGE		W2 PHASE A CURRENT 0 A at 0° Lag

MESSAGE		W2 PHASE B CURRENT 0 A at 0° Lag
MESSAGE		W2 PHASE C CURRENT 0 A at 0° Lag
MESSAGE		W2 GROUND CURRENT 0 A at 0° Lag
MESSAGE		W2 (% fo) H2a: 0.0 H2b: 0.0 H2c: 0.0
MESSAGE		W2 (% fo) H5a: 0.0 H5b: 0.0 H5c: 0.0
MESSAGE		W3 PHASE A CURRENT 0 A at 0° Lag
MESSAGE		W3 PHASE B CURRENT 0 A at 0° Lag
MESSAGE		W3 PHASE C CURRENT 0 A at 0° Lag
MESSAGE		W3 GROUND CURRENT 0 A at 0° Lag
MESSAGE		W3 (% fo) H2a: 0.0 H2b: 0.0 H2c: 0.0
MESSAGE		W3 (% fo) H5a: 0.0 H5b: 0.0 H5c: 0.0
MESSAGE		PHASE A DIFFERENTIAL CURRENT: 0.00 x CT
MESSAGE		PHASE B DIFFERENTIAL CURRENT: 0.00 x CT
MESSAGE		PHASE C DIFFERENTIAL CURRENT: 0.00 x CT
MESSAGE		PHASE A RESTRAINT CURRENT: 0.00 x CT
MESSAGE		PHASE B RESTRAINT CURRENT: 0.00 x CT
MESSAGE		PHASE C RESTRAINT CURRENT: 0.00 x CT
MESSAGE		SYSTEM FREQUENCY: 0.00 Hz
MESSAGE		FREQUENCY DECAY RATE: 0.00 Hz/s
MESSAGE		TAP CHANGER POSITION: n/a
MESSAGE		VOLTS-PER-HERTZ: 0.00 V/Hz
MESSAGE		AMBIENT TEMPERATURE: 0°C
MESSAGE		ANALOG INPUT: 0 μA

The event record runs continuously, capturing and storing conditions present at the moment of occurrence of the last 256 events, as well as the time and date of each event. The header message for each event contains two pieces of information: the event number (higher numbers denote more recent events) and the event date. If the event record is clear or if the date has never been programmed, "Unavailable" is displayed instead of a date. No more than 256 events are stored at the same time.

Pickup events are not recorded for elements that operate instantaneously (for example, percent differential, instantaneous differential, etc.). Also, elements that have operate times set to 0.00 seconds will not log pickup events. If the operate delay is set higher than 0.00, then the event recorder logs both the pickup and the operate events.

Test Mode 2 event is recorded for serial port command, using DNP protocol, to perform cold restart. Test Mode 3 event is recorded for serial port command to perform firmware upload.

Diagnostic message 1 is caused when 745 detects transients inside the 745.

Table 6-1: Types and causes of events

PICKUP / OPERATE / DROPOUT Events		
Percent Differential	Inst Differential	W1 Phase Time OC
W2 Phase Time OC	W3 Phase Time OC	W1 Phase Inst OC 1
W2 Phase Inst OC 1	W3 Phase Inst OC 1	W1 Phase Inst OC 2
W2 Phase Inst OC 2	W3 Phase Inst OC 2	W1 Neutral Time OC
W2 Neutral Time OC	W3 Neutral Time OC	W1 Neutral Inst OC 1
W2 Neutral Inst OC 1	W3 Neutral Inst OC 1	W1 Neutral Inst OC 2
W2 Neutral Inst OC 2	W3 Neutral Inst OC 2	W1 Ground Time OC
W2 Ground Time OC	W3 Ground Time OC	W1 Ground Inst OC 1
W2 Ground Inst OC 1	W3 Ground Inst OC 1	W1 Ground Inst OC 2
W2 Ground Inst OC 2	W3 Ground Inst OC 2	W1 Restd Gnd Fault
W2 Restd Gnd Fault	W3 Restd Gnd Fault	W1 Neg Seq Time OC
W2 Neg Seq Time OC	W3 Neg Seq Time OC	W1 Neg Seq Inst OC
W2 Neg Seq Inst OC	W3 Neg Seq Inst OC	Underfrequency 1
Underfrequency 2	Frequency Decay 1	Frequency Decay 2
Frequency Decay 3	Frequency Decay 4	Overfrequency
5th Harmonic Level	Volts-Per-Hertz 1	Volts-Per-Hertz 2
W1 THD Level	W2 THD Level	W3 THD Level
W1 Harmonic Derating	W2 Harmonic Derating	W3 Harmonic Derating
Analog Level 1	Analog Level 2	W1 Current Demand
W2 Current Demand	W3 Current Demand	Transformer Overload
ON/OFF events		
Logic Input 1	Logic Input 2	Logic Input 3
Logic Input 4	Logic Input 5	Logic Input 6
Logic Input 7	Logic Input 8	Logic Input 9
Logic Input 10	Logic Input 11	Logic Input 12
Logic Input 13	Logic Input 14	Logic Input 15
Logic Input 16	Virtual Input 1	Virtual Input 2
Virtual Input 3	Virtual Input 4	Virtual Input 5
Virtual Input 6	Virtual Input 7	Virtual Input 8
Virtual Input 9	Virtual Input 10	Virtual Input 11

Table 6-1: Types and causes of events (Continued)

Virtual Input 12	Virtual Input 13	Virtual Input 14
Virtual Input 15	Virtual Input 16	Output Relay 1
Output Relay 2	Output Relay 3	Output Relay 4
Output Relay 5	Output Relay 6	Output Relay 7
Output Relay 8	Self-Test Relay	Virtual Output 1
Virtual Output 2	Virtual Output 3	Virtual Output 4
Virtual Output 5	Control Power	Test Mode
Test Mode 2	Test Mode 3	
ERROR! events		
Logic Input Power	Analog Output Power	Unit Not Calibrated
EEPROM Memory	Real-Time Clock	Emulation Software
Int. Temperature	FlexLogic Equation	DSP Processor
Bad Xfmr Settings	IRIG-B Signal	Setpt Access Denied
Ambnt temperature	Diagnostic Message 1	

The following events are always logged. That is, they are logged regardless of any event recorder settings (they cannot be disabled).

Table 6-2: Continually logged events

Setpoint Group 1	Setpoint Group 2	Setpoint Group 3
Setpoint Group 4	Simulation Disabled	Simulation Prefault
Simulation Fault	Simulation Playback	Logic Input Reset
Front Panel Reset	Comm Port Reset	Manual Trace Trigger
Auto Trace Trigger	Aging Factor Limit	Ambient Temperature
Tap Changer Failure	DSP Processor	Test Mode 2
Test Mode 3	Diagnostic Message 1	



The recorded event displayed for logic inputs, virtual inputs, and relay outputs will show the programmed name of the input/output.



If Power to the SR745 is switched off before the relay is completely booted up and in service, a false event could be recorded in the event recorder.

6.5 A4 Product Information

6.5.1 Technical Support

PATH: ACTUAL VALUES ▾ ▾ A4 PRODUCT INFO ▾ TECHNICAL SUPPORT

<p>■ TECHNICAL SUPPORT ▷ </p>		<p>GE Multilin 215 Anderson Avenue</p>
MESSAGE		<p>Markham, Ontario, Canada, L6E 1B3</p>
MESSAGE		<p>Tel: (905) 294-6222 Fax: (905) 201-2098</p>
MESSAGE		<p>Internet Address: GEindustrial.com/pm</p>

The manufacturer's contact information for technical support is shown here.

6.5.2 Revision Codes



PATH: ACTUAL VALUES ▾ ▾ A4 PRODUCT INFO ▾ ▾ REVISION CODES

<p>■ REVISION CODES ▷ </p>		<p>■ ■ 745 Transformer ■ ■ Management Relay</p>
MESSAGE		<p>HARDWARE REVISION: H</p>
MESSAGE		<p>FIRMWARE REVISION: 500</p>
MESSAGE		<p>BOOTWARE REVISION: 300</p>
MESSAGE		<p>VERSION NUMBER: 000</p>
MESSAGE		<p>INSTALLED OPTIONS: W3-P1-G1-LO-ALR</p>
MESSAGE		<p>SERIAL NUMBER: D33xxxxx</p>
MESSAGE		<p>MANUFACTURE DATE: Jan 01 2006</p>

Hardware and firmware revision codes are shown here.

6.5.3 Calibration

PATH: ACTUAL VALUES ▷ ▾ A4 PRODUCT INFO ▷ ▾ CALIBRATION

■ CALIBRATION ▷		ORIGINAL CALIBRATION DATE: Jan 01 2001
MESSAGE		LAST CALIBRATION DATE: Jan 01 2001

The initial and most recent calibration dates are shown here.

6.6 Target and Flash Messages

6.6.1 Target Messages

Target messages are displayed when any protection, monitoring or self-test target is activated. The messages contain information about the type of the active target(s), and are displayed in a queue that is independent of both the setpoint and actual value message structures.

When any target is active, the Message LED will turn on, and the first message in the queue is displayed automatically. The target message queue may be scrolled through by pressing the MESSAGE DOWN and UP keys.

As long as there is at least one message in the queue, the Message LED will remain lit. Pressing any key other than MESSAGE DOWN or UP will return the display to the setpoint or actual value message that was previously displayed. The MESSAGE DOWN and UP keys may be pressed any time the Message LED is lit to re-display the target message queue.

If the MESSAGE RIGHT key is pressed when no target messages are in the queue, the following flash message will appear:

NO ACTIVE TARGETS

A typical active target message looks like this,

■ **LATCHED: a**
 ■ **Percent Different**

and consists of three components which are arranged as follows:

■ **<STATUS>: <PHASE>**
 ■ **<CAUSE>**

The **<STATUS>** part of the above message will be one of **PICKUP**, **OPERATE** or **LATCHED**:

- **PICKUP**: Indicates that the fault condition that is required to activate the protection element has been detected by the 745 but has not persisted for a sufficiently long time to cause the relay to activate its protection function.
- **OPERATE**: Indicates that the protection element has been activated.
- **LATCHED**: Indicates that the protection element is (or was) activated. This display will remain even if the conditions that caused the element to activate are removed.

The **<PHASE>** part of the message represents the phase(s) that are associated with the element (where applicable).

Messages for **LATCHED** targets remain in the queue until the relay is reset. Messages for **PICKUP** and **OPERATE** targets remain in the queue as long as the condition causing the target to be active is present. In addition, messages for **LATCHED** targets will automatically be deleted if an entire week passes without any changes to the state of the target messages but the conditions that caused the **LATCHED** messages to be displayed originally are no longer present.

The bottom line of the display (i.e., **<CAUSE>**) will be the name of the element that has been activated. These are as follows:

Table 6-3: Target message causes

Percent Differentl	Inst Differential	W1 Phase Time OC
W2 Phase Time OC	W3 Phase Time OC	W1 Phase Inst OC 1
W2 Phase Inst OC 1	W3 Phase Inst OC 1	W1 Phase Inst OC 2
W2 Phase Inst OC 2	W3 Phase Inst OC 2	W1 Ntrl Time OC
W2 Ntrl Time OC	W3 Ntrl Time OC	W1 Ntrl Inst OC 1
W2 Ntrl Inst OC 1	W3 Ntrl Inst OC 1	W1 Ntrl Inst OC 2
W2 Ntrl Inst OC 2	W3 Ntrl Inst OC 2	W1 Gnd Time OC
W2 Gnd Time OC	W3 Gnd Time OC	W1 Gnd Inst OC 1
W2 Gnd Inst OC 1	W3 Gnd Inst OC 1	W1 Gnd Inst OC 2
W2 Gnd Inst OC 2	W3 Gnd Inst OC 2	W1 Rest Gnd Fault
W2 Rest Gnd Fault	W3 Rest Gnd Fault	W1 Neg Seq Time OC
W2 Neg Seq Time OC	W3 Neg Seq Time OC	W1 Neg Seq Inst OC
W2 Neg Seq Inst OC	W3 Neg Seq Inst OC	Underfrequency 1
Underfrequency 2	Freq Decay Rate 1	Freq Decay Rate 2
Freq Decay Rate 3	Freq Decay Rate 4	Overfrequency
5th Harmonic Level	Volts-per-hertz 1	Volts-per-hertz 2
W1 THD Level	W2 THD Level	W3 THD Level
W1 Harmonic Derating	W2 Harmonic Derating	W3 Harmonic Derating
Analog Level 1	Analog Level 2	W1 Current Demand
W2 Current Demand	W3 Current Demand	Xformer Overload
Logic Input 1 (to 16)	Virtual Input 1 (to 16)	

The recorded event displayed for logic inputs and virtual inputs will show the programmed name of the input/output. An active target display may also be generated as a result of a self-test error. When this occurs, the self-test error target message will be displayed Refer to *Self-test Errors* on page 6-25 for a list of self-test error messages.

As well, there is an additional message that may appear as a target message. It looks like this:

SETPOINTS HAVE NOT BEEN PROGRAMMED!

This message will be placed in the target message queue whenever **S1 745 SETUP ▾ ▽ INSTALLATION ▸ 745 SETPOINTS** is set to "Not Programmed". This serves as a warning that the relay has not been programmed for the installation and is therefore not in the in-service state.

6.6.2 Self-test Errors

The 745 performs self-diagnostics at initialization (after power-up), and continuously thereafter (in a background task). The tests ensure that every testable unit of the hardware is functioning correctly.



Any self-test error indicates a serious problem requiring service.

Major self-test errors:

Upon detection of a major self-test error, the 745:

- disables all protection functionality
- turns on the front panel Self-Test Error LED
- turns off the front panel In Service LED
- de-energizes all output relays, including the self-test relay
- indicates the failure by inserting an appropriate message in the target message queue
- records the failure in the event recorder

Minor self-test errors:

Upon detection of a minor self-test error, the 745:

- turns on the front panel Self-Test Error LED
- de-energizes the Self-Test Relay
- indicates the failure by inserting an appropriate message in the target message queue
- records the failure in the event recorder

All conditions listed in the following table cause a target message to be generated.

Table 6-4: Self-test error interpretation

Event message	Target message	Severity	Cause
Logic Input Power	Self-Test Warning 0 Replace Immediately	Minor	This error is caused by failure of the +32 V DC power supply used to power dry contacts of logic inputs. Logic inputs using internal power are affected by this failure. This may be caused by an external connection which shorts this power supply to ground.
Analog Output Power	Self-Test Warning 1 Replace Immediately	Minor	This error is caused by failure of the +32 V DC power supply used to power analog outputs. Analog output currents are affected by this failure.
Unit Not Calibrated	Unit Not Calibrated Replace Immediately	Minor	This error message appears when the 745 determines that it has not been calibrated. Although the relay is fully functional, the accuracy of measured input values (e.g. currents and line voltage) as well as generated outputs (e.g. analog outputs) is not likely to be within those specified for the relay.

Table 6–4: Self-test error interpretation (Continued)

Event message	Target message	Severity	Cause
EEPROM Memory	Self-Test Warning 2 Replace Immediately	Major	This error is caused by detection of corrupted location in the 745 data memory which cannot be self-corrected. Errors that can be automatically corrected are not indicated. Any function of the 745 is susceptible to maloperate from this failure.
Clock Not Set	Clock Not Set Program Date/Time	Minor	This error is caused when the 745 detects that the real-time clock is not running. Under this condition, the 745 will not be able to maintain the current time and date. This would normally occur if backup power for the clock is lost and control power is removed from the 745. Even if control power is restored, the clock will not operate until the time and/or date are programmed via the S1 745 SETUP ▷▽ CLOCK menu.
Emulation Software	Self-Test Warning 4 Replace Immediately	Minor	This error is caused by development software being loaded in the relay.
Int Temperature	Unit Temp. Exceeded ServiceCheckAmbient	Minor	The relay has detected an unacceptably low (< -40°C) or high (> 85°C) temperature inside the unit.
Flexlogic Equation	Flexlogic Eqn Error Consult User Manual	Major	This error is caused by the detection of unacceptably low (less than -40°C) or high (greater than +85°C) temperatures detected inside the unit
DSP Processor	Self-Test Warning 6 Replace Immediately	Major	This error is caused when communications with the internal digital signal processor is lost. Most of the monitoring capability of the 745 (including all measurement of current) will be lost when this failure occurs.
Bad Xfmr Settings	Bad Xfmr Settings Consult User Manual	Major	This error is caused when the 745 determines that the transformer configuration programmed via setpoints does not correspond to a realistic physical system.
IRIG-B Signal	IRIG-B Error Consult User Manual	Minor	This error is caused when the IRIG-B signal type selected does not match the format code being injected into the IRIG-B terminals.
Setpt Access Denied	Setpoint Access Denied Consult User Manual	Minor	This error is caused when the passcode is entered incorrectly three times in a row from either the front panel or any of the communication ports. This error may be removed by entering the correct passcode.
Ambient Temperature	Amb. Temp. Exceeded Check Ambient	Minor	This error is caused when ambient temperature is out of range.(-50 to 250°C inclusive).
Self-Test Warning 7	Self-Test Warning 7 Call Service	Minor	This warning is caused by 745 microprocessor reset forced by watchdog circuit.
Self-Test Warning 9	Self-Test Warning 9 Call Service	Minor	This warning is caused when cumulative time for Diagnostic Message 1 exceeds tolerance. To clear this condition, reset 745 relay.

Table 6–4: Self-test error interpretation (Continued)

Event message	Target message	Severity	Cause
Self-Test Warning 10	Self-Test Warning 10 Call Service	Minor	This warning is caused by 745 microprocessor self-monitoring its own tasks.
Self-Test Warning 11	Self-Test Warning 11 Call Service	Minor	This warning is caused at power-on by fault in microprocessor reset status.

6.6.3 Flash Messages

Flash messages are warning, error, or general information messages displayed in response to certain key presses. The length of time these messages remain displayed can be programmed in **S1 745 SETUP ▸ ▾ PREFERENCES ▸ ▾ FLASH MESSAGE TIME**. The factory default flash message time is 4 seconds.

ADJUSTED VALUE HAS BEEN STORED

This flash message is displayed in response to pressing ENTER while on a setpoint message with a numerical value. The edited value had to be adjusted to the nearest multiple of the step value before it was stored.

COMMAND IS BEING EXECUTED

This flash message is displayed in response to executing a command at a command message. Entering “Yes” at a command message will display the message **ARE YOU SURE?**. Entering “Yes” again will perform the requested command, and display this flash message.

DEFAULT MESSAGE HAS BEEN ADDED

This flash message is displayed in response to pressing the decimal key, followed by ENTER twice, on any setpoint or actual value message except those in the default messages subgroup.

DEFAULT MESSAGE HAS BEEN REMOVED

This flash message is displayed in response to pressing the decimal key, followed by ENTER twice, on one of the selected default messages in the default messages subgroup.

ENTERED PASSCODE IS INVALID

This flash message is displayed in response to an incorrectly entered passcode when attempting to enable or disable setpoint access. It is also displayed when an attempt has been made to upgrade to an option without the correct passcode.

ENTRY MISMATCH – CODE NOT STORED

This flash message is displayed while changing the programmed passcode from the change passcode command. If the passcode entered at the prompt **PLEASE RE-ENTER NEW PASSCODE is different** from the one entered at the prompt **PLEASE ENTER A NEW PASSCODE**, the 745 will not store the entered passcode, and display this flash message.

INPUT FUNCTION IS ALREADY ASSIGNED	(a) This flash message is displayed under certain conditions when attempting to assign logic input functions under S3 LOGIC INPUTS . Only the “Disabled” and “To FlexLogic” functions can be assigned to more than one logic input. If an attempt is made to assign any another function to a logic input when it is already assigned to another logic input, the assignment will not be made and this message will be displayed, (b) Ground Input Selection settings also use this flash message.
INVALID KEY: MUST BE IN LOCAL MODE	This flash message is displayed in response to pressing RESET while the 745 is in remote mode. The 745 must be put into local mode in order for this key to be operational.
INVALID SERIAL NUMBER	This flash message is displayed when an attempt is made to upgrade installed options and the 745 detects an invalid serial number.
NEW PASSCODE HAS BEEN STORED	This flash message is displayed in response to changing the programmed passcode from the setpoint S1 745 SETUP ▷ PASSCODE ▷▽ CHANGE PASSCODE . The directions to change the passcode were followed correctly, and the new passcode was stored as entered.
NEW SETPOINT HAS BEEN STORED	This flash message is displayed in response to pressing ENTER while editing on any setpoint message. The edited value was stored as entered.
NO ACTIVE TARGETS (TESTING LEDS)	This flash message is displayed in response to the MESSAGE UP or DOWN key while the Message LED is off. There are no active conditions to display in the target message queue.
OUT OF RANGE – VALUE NOT STORED	This flash message is displayed in response to pressing ENTER while on a setpoint message with a numerical value. The edited value was either less than the minimum or greater than the maximum acceptable value for this setpoint and, as a result, was not stored.
PASSCODE VALID - OPTIONS ADJUSTED	This flash message is displayed when an attempt to upgrade an option was successful.
PLEASE ENTER A NON-ZERO PASSCODE	This flash message is displayed while changing the passcode from the S1 745 SETUP ▷ PASSCODE ▷▽ CHANGE PASSCODE setpoint. An attempt was made to change the passcode to “0” when it was already 0.
PRESS [ENTER] TO ADD AS DEFAULT	This flash message is displayed for 5 seconds in response to pressing the decimal key followed by ENTER while displaying any setpoint or actual value message except the S1 745 SETUP ▷▽ DEFAULT MESSAGES ▷▽ SELECTED DEFAULTS setpoint. Pressing ENTER again while this message is displayed adds the setpoint or actual value message to the default list.

**PRESS [ENTER] TO
BEGIN TEXT EDIT**

This flash message is displayed in response to pressing the VALUE keys while on a setpoint message with a text entry value. The ENTER key must first be pressed to begin editing.

**PRESS [ENTER] TO
REMOVE MESSAGE**

This flash message is displayed for 5 seconds in response to pressing the decimal key followed by ENTER while displaying one of the selected default messages in the [S1 745 SETUP ▷ ▽ DEFAULT MESSAGES ▷ ▽ SELECTED DEFAULTS](#) menu. Pressing ENTER again while this message is displayed removes the default message.

**PRESSED KEY
IS INVALID HERE**

This flash message is displayed in response to any pressed key that has no meaning in the current context.

**RESETTING LATCHED
CONDITIONS**

This flash message is displayed in response to pressing RESET when the relay is in local mode. All active targets for which the activating condition is no longer present will be cleared.

**SETPOINT ACCESS
DENIED (PASSCODE)**

This flash message is displayed in response to pressing ENTER while on any setpoint message. Setpoint access is restricted because the programmed passcode has not been entered to allow access.

**SETPOINT ACCESS
DENIED (SWITCH)**

This flash message is displayed in response to pressing ENTER while on any setpoint message. Setpoint access is restricted because the setpoint access terminals have not been connected.

**SETPOINT ACCESS
IS NOW ALLOWED**

This flash message is displayed in response to entering the programmed passcode at the [S1 745 SETUP ▷ ▽ PASSCODE ▷ ▽ ALLOW SETPOINT WRITE ACCESS](#) setpoint. The command to allow write access to setpoints has been successfully executed and setpoints can be changed and entered.

**SETPOINT ACCESS
IS NOW RESTRICTED**

This flash message is displayed in response to correctly entering the programmed passcode at [S1 745 SETUP ▷ ▽ PASSCODE ▷ ▽ ALLOW SETPOINT WRITE ACCESS](#). The command to restrict access to setpoints has been successfully executed and setpoints cannot be changed.



745 Transformer Protection System

Chapter 7: Commissioning

7.1 General

7.1.1 Introduction

The procedures contained in this section can be used to verify the correct operation of the 745 Transformer Protection System prior to placing it into service for the first time. These procedures may also be used to verify the relay on a periodic basis. Although not a total functional verification, the tests in this chapter verify the major operating points of all features of the relays. Before commissioning the relay, users should read the installation chapter, which provides important information about wiring, mounting, and safety concerns. The user should also become familiar with the relay as described in the setpoints and actual values chapters.

Test personnel must be familiar with general relay testing practices and safety precautions to avoid personal injuries or equipment damage.

This chapter is divided into several sections, as follows:

- **GENERAL:** outlines safety precautions, conventions used in the test procedures.
- **TEST EQUIPMENT:** the test equipment required.
- **GENERAL PRELIMINARY WORK**
- **LOGIC INPUTS AND OUTPUT RELAYS:** tests all digital and analog inputs, the analog-to-digital data acquisition system, and relay and transistor outputs.
- **DISPLAY, METERING, COMMUNICATIONS, ANALOG OUTPUTS:** tests all values derived from the AC current and voltage inputs.
- **PROTECTION SCHEMES:** tests all features that can cause a trip, including differential, overcurrent, over and underfrequency elements.
- **AUXILIARY PROTECTION/MONITORING FUNCTIONS**
- **PLACING RELAY INTO SERVICE**
- **SETPOINT TABLES**

7.1.2 Testing Philosophy

The 745 is realized with digital hardware and software algorithms, using extensive internal monitoring. Consequently, it is expected that, if the input circuits, CTs, VTs, power supply, auxiliary signals, etc., are functioning correctly, all the protection and monitoring features inside the relay will also perform correctly, as per applied settings. It is therefore only necessary to perform a calibration of the input circuits and cursory verification of the protection and monitoring features to ensure that a fully-functional relay is placed into service.

Though tests are presented in this section to verify the correct operation of all features contained in the 745, only those features which are placed into service need be tested. Skip all sections which cover features not included or not enabled when the relay is in service, except for the provision of the next paragraph.

Some features such as the Local/Remote Reset of targets, display messages and indications are common to all the protection features and hence are tested only once. Testing of these features has been included with the Harmonic Restraint Percent Differential, which will almost always be enabled. If, for some reasons, this element is not enabled when the relay is in service, you will need to test the Local/Remote Reset when testing another protection element.

7.1.3 Safety Precautions

Ensure the following precautions are observed before testing the relay.



HIGH VOLTAGES ARE PRESENT ON THE REAR TERMINALS OF THE RELAY, CAPABLE OF CAUSING DEATH OR SERIOUS INJURY. USE CAUTION AND FOLLOW ALL SAFETY RULES WHEN HANDLING, TESTING, OR ADJUSTING THE EQUIPMENT.



DO NOT OPEN THE SECONDARY CIRCUIT OF A LIVE CT, SINCE THE HIGH VOLTAGE PRODUCED IS CAPABLE OF CAUSING DEATH OR SERIOUS INJURY, OR DAMAGE TO THE CT INSULATION.



THE RELAY USES COMPONENTS WHICH ARE SENSITIVE TO ELECTROSTATIC DISCHARGES. WHEN HANDLING THE UNIT, CARE SHOULD BE TAKEN TO AVOID ELECTRICAL DISCHARGES TO THE TERMINALS AT THE REAR OF THE RELAY.



ENSURE THAT THE CONTROL POWER APPLIED TO THE RELAY, AND THE AC CURRENT AND VOLTAGE INPUTS, MATCH THE RATINGS SPECIFIED ON THE RELAY NAMEPLATE. DO NOT APPLY CURRENT TO THE CT INPUTS IN EXCESS OF THE SPECIFIED RATINGS.



ENSURE THAT THE LOGIC INPUT WET CONTACTS ARE CONNECTED TO VOLTAGES BELOW THE MAXIMUM VOLTAGE SPECIFICATION OF 300 V DC.

7.1.4 Conventions

The following conventions are used for the remainder of this chapter:

- All setpoints and actual values are mentioned with their path as a means of specifying where to find the particular message. For instance, the setpoint **WINDING 1 PHASE CT PRIMARY**, which in the message structure is located under setpoints page S2, would be written as:

S2 SYSTEM SETUP ▷▽ WINDING 1 ▷▽ WINDING 1 PHASE CT PRIMARY

- Normal phase rotation of a three-phase power system is ABC.
- The phase angle between a voltage signal and a current signal is positive when the voltage leads the current.
- Phase A to neutral voltage is indicated by V_{an} (arrowhead on the "a").
- Phase A to B voltage is indicated by V_{ab} (arrowhead on the "a").
- The neutral current signal is the $3I_0$ signal derived from the three phase currents for any given winding.
- The ground current is the current signal measured by means of a CT in the power transformer connection to ground.

7.1.5 Test Equipment

It is possible to completely verify the 745 relay operation using the built-in test and simulation features described earlier in this manual. However, some customers prefer to perform simple signal-injection tests to verify the basic operation of each element placed into service. The procedures described in this chapter have been designed for this purpose. To use the built-in facilities, refer to the appropriate sections in this manual.

The conventional, decades-old approach to testing relays utilized adjustable voltage and current sources, variacs, phase shifters, multimeters, timing device, and the like. In the last few years several instrumentation companies have offered sophisticated instrumentation to test protective relays. Generally this equipment offers built-in sources of AC voltage and current, DC voltage and current, timing circuit, variable frequency, phase shifting, harmonic generation, and complex fault simulation. If using such a test set, refer to the equipment manufacturer's instructions to generate the appropriate signals required by the procedures in this section. If you do not have a sophisticated test set, then you will need the following 'conventional' equipment:

- Variable current source able to supply up to 40 A (depends on relay settings)
- Variable power resistors to control current amplitude
- Ten-turn 2 k Ω low-power potentiometer
- Power rectifier to build a circuit to generate 2nd harmonics
- Accurate timing device
- Double-pole single-throw contactor suitable for at least 40 amperes AC.
- Combined fundamental and 5th-harmonic adjustable current supply for elements involving the 5th harmonic.
- Variable-frequency source of current or voltage to test over/underfrequency and frequency trend elements.
- Ammeters (RMS-responding), multimeters, voltmeters
- variable DC mA source
- variable DC mV source

- single-pole single-throw contactor

The simple test setup shown below can be used for the majority of tests. When the diode is not shorted and the two currents are summed together prior to the switch, the composite current contains the 2nd harmonic necessary to verify the 2nd harmonic restraint of the harmonic restraint percent differential elements. With the diode shorted and the two currents fed to separate relay inputs, the slope of the differential elements can be measured. With only I_1 connected (with a return path) the pickup level of any element can be measured.

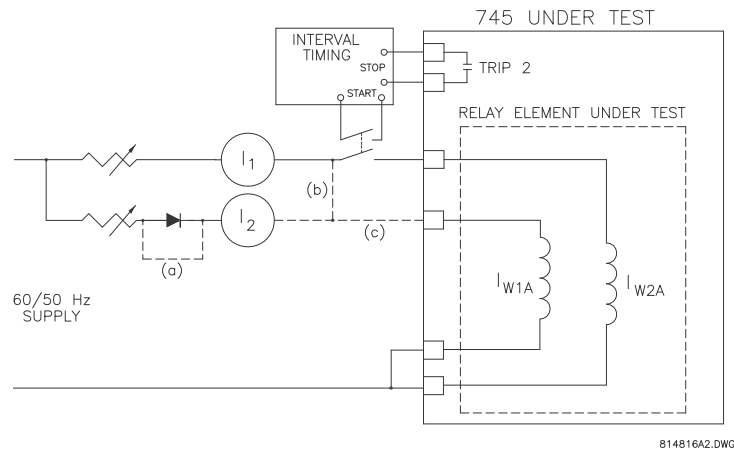

FIGURE 7-1: Test setup

7.2 Preliminary Work

7.2.1 Description

- ▷ Review appropriate sections of this manual to familiarize yourself with the relay. Confidence in the commissioning process comes with knowledge of the relay features and methods of applying settings.
- ▷ Verify the installation to ensure correct connections of all inputs and outputs.
- ▷ Review the relay settings and/or determine features and settings required for your installation. In large utilities a central group is often responsible for determining which relay features will be enabled and which settings are appropriate. In a small utility or industrial user, the on-site technical person is responsible both for the settings and also for the complete testing of the relay.
- ▷ Set the relay according to requirements.
Ensure that the correct relay model has been installed. A summary table is available in this manual for users to record all the relay settings.
- ▷ When the testing is completed, verify the applied relay settings, and verify that all desired elements have been enabled, using the EnerVista 745 Setup software or the relay front panel.
- ▷ Verify that the relay rated AC current matches the CT secondary value.
- ▷ Verify that the relay rated AC voltage matches the VT secondary value.
- ▷ Verify that the relay rated frequency setting matches the power system frequency.
- ▷ Open all blocking switches so as not to issue an inadvertent trip signal to line breakers.
- ▷ Verify that the auxiliary supply matches relay nameplate. Turn the auxiliary supply on.
- ▷ Verify that all grounding connections are correctly made.

To facilitate testing it is recommended that all functions be initially set to Disabled. Every feature which will be used in the application should be set per desired settings, enabled for the specific commissioning test for the feature, then returned to Disabled at completion of its test. Each feature can then be tested without complications caused by operations of other features. At the completion of all commissioning tests all required features are then Enabled.



It is necessary to keep track of modifications/changes made to settings during the course of these commissioning steps and ensure that all settings are returned to the 'in-service' values at the end of the tests, prior to placing the relay into service.

7.2.2 Dielectric Strength Testing

The 745 is rated for 1.9 kV AC for 1 second or 1.6 kV for 1 minute (as per UL 508) isolation between relay contacts, CT inputs, VT inputs and the safety ground terminal G12. Some precautions are required to prevent 745 damage during these tests.

Filter networks and transient protection clamps are used between control power and the filter ground terminal G11. This filtering is intended to filter out high voltage transients, radio frequency interference (RFI), and electromagnetic interference (EMI). The filter capacitors and transient suppressors could be damaged by application continuous high voltage. Disconnect filter ground terminal G11 during testing of control power and trip coil supervision. CT inputs, VT inputs, and output relays do not require any special precautions. Low voltage inputs (< 30 V) such as RTDs, analog inputs, analog outputs, digital inputs, and RS485 communication ports are not to be tested for dielectric strength under any circumstance.

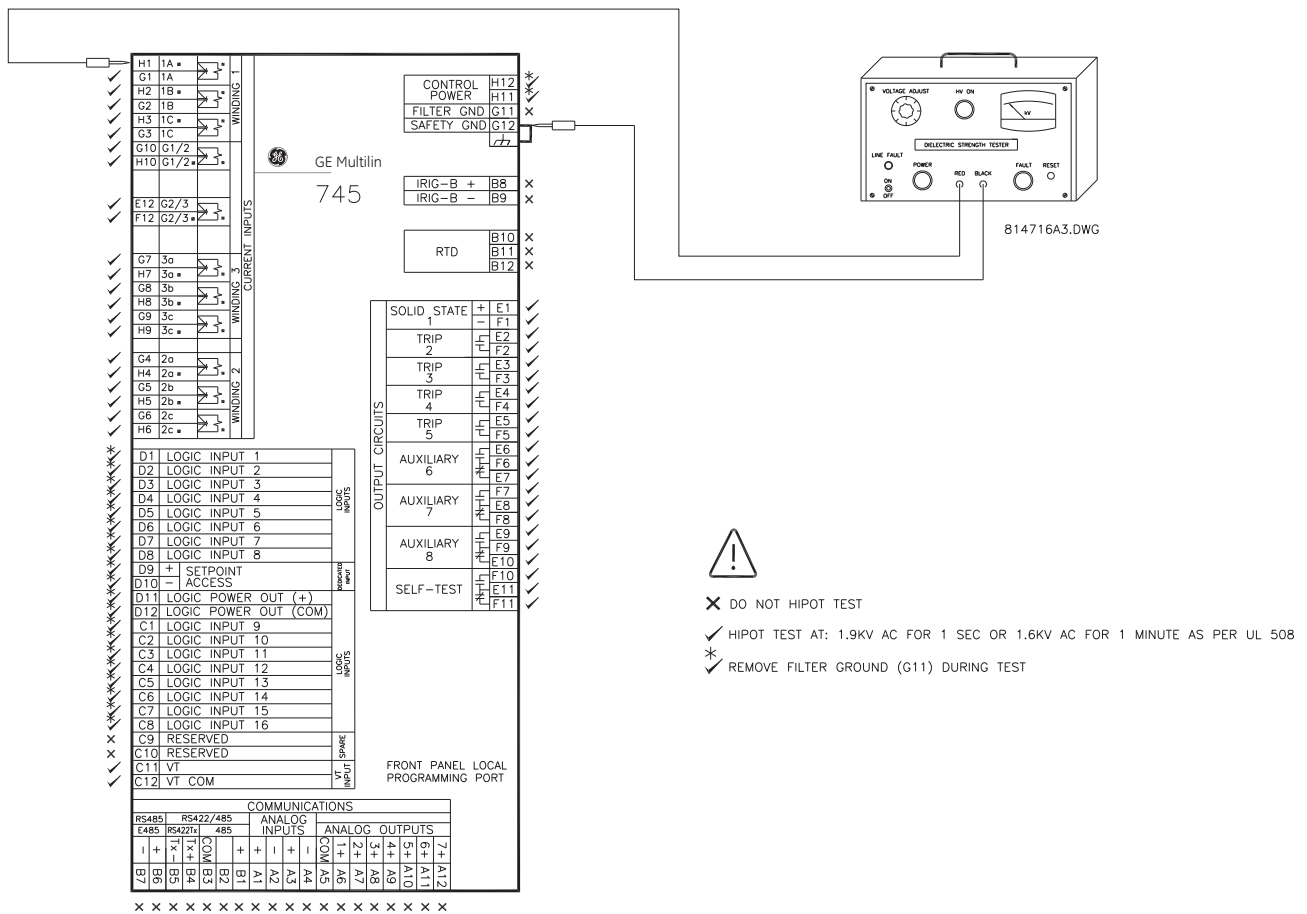

FIGURE 7-2: Testing for dielectric strength

7.3 Logic Inputs and Output Relays

7.3.1 Logic Inputs

The dry and wet contact connections are shown below:

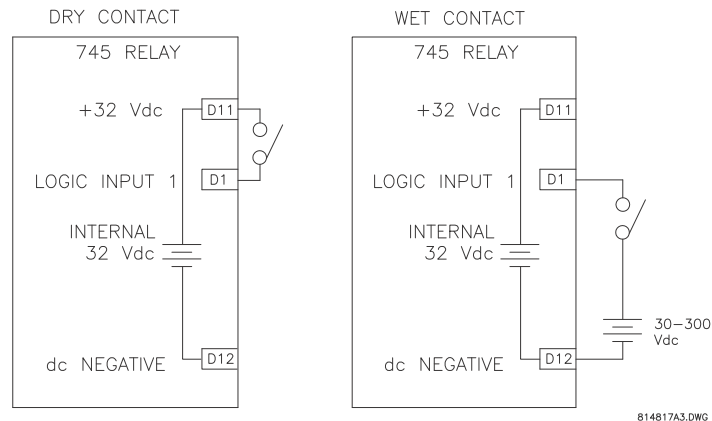

FIGURE 7-3: Logic inputs

- ▷ Prior to energizing any of the Logic Inputs, ensure that doing so will not cause a relay trip signal to be issued beyond the blocking switches. These should have been opened prior to starting on these tests. If you wish, you can disable the Logic Input functions by setting:
 - [S3 LOGIC INPUTS](#) ▷ [LOGIC INPUT 1 \(16\)](#) ▷ [LOGIC INPUT 1\(16\) FUNCTION: "Disabled"](#)
- ▷ Connect a switch between Logic Input 1 (Terminal D1) and +32 V DC (Terminal D12), as shown above (alternatively, use the wet contact approach shown in the same figure). Logic Inputs can be asserted with either an opened or closed contact, per the user choice. Verify/set the type of Logic Input to be used with the following setpoint:
 - [S3 LOGIC INPUTS](#) ▷ [LOGIC INPUTS](#) ▷ [LOGIC INPUT 1 \(16\)](#) ▷ [INPUT 1\(16\) ASSERTED STATE](#)
- ▷ Display the status of the Logic Input using the [A1 STATUS](#) ▷ [LOGIC INPUTS](#) ▷ [LOGIC INPUT 1\(16\) STATE](#) actual value.
- ▷ With the switch contact open (or closed), check that the input state is detected and displayed as **Not Asserted**.
- ▷ Close (open) the switch contacts. Check that the input state is detected and displayed as **Asserted**.
- ▷ Repeat for all the relay logic inputs which are used in your application.

7.3.2 Output Relays

- ▷ To verify the proper functioning of the output relays, enable the Force Output Relays function by setting:
 - **S6 TESTING ▷ OUTPUT RELAYS ▷ FORCE OUTPUT RELAYS FUNCTION: Enabled**
The Test Mode LED on the front of the relay will come ON, indicating that the relay is in test mode and no longer in service. In test mode all output relays can be controlled manually.
- ▷ Under **S6 TESTING ▷ OUTPUT RELAYS** set the **FORCE OUTPUT 1** to **FORCE OUTPUT 8** setpoints to **De-energized**.
- ▷ Using a multimeter, check that all outputs are de-energized. For outputs 2 to 5, the outputs are dry N.O. contacts and for outputs 6 to 8, the outputs are throw-over contacts (form-C). Output 1 is a solid state output. When de-energized, the resistance across E1 and F1 will be greater than 2 M Ω ; when energized, and with the multimeter positive lead on E1, the resistance will be 20 to 30 k Ω .
- ▷ Now change the **FORCE OUTPUT 1** to **FORCE OUTPUT 8** setpoints to **Energized**.
- ▷ Using a multimeter, check that all outputs are now energized.
- ▷ Now return all output forcing to **De-energized** and disable the relay forcing function by setting **S6 TESTING ▷ OUTPUT RELAYS ▷ FORCE OUTPUT RELAYS FUNCTION** to **Disabled**.

All the output relays should reset.

7.4 Metering

7.4.1 Description

Accuracy of readings taken in this section should be compared with the specified accuracies in *Specifications* on page 2–5. If the measurements obtained during this commissioning procedure are ‘out-of-specification’ verify your instrumentation accuracy. If the errors are truly in the relay, advise the company representative.

7.4.2 Current Inputs

The general approach used to verify the AC current inputs is to supply rated currents in all the input CTs. Displayed readings will then confirm that the relay is correctly measuring all the inputs and performing the correct calculations to derive sequence components, loading values, etc. Since the displayed values are high-side values, you can use this test to verify that the CT ratios have been correctly entered.

- ▷ If you are using a single phase current supply, connect this current signal to all the input CTs in series, winding 1, 2 and 3, if using a three-winding configuration, and the ground CT input(s). Adjust the current level to 1 A for 1-amp-rated relays and to 5 A for 5-amp-rated relays. **Some elements may operate under these conditions unless all elements have been disabled!**
- ▷ With the above current signals ON, read the actual values displayed under **A2 METERING ▷ CURRENT**. The actual values can be quickly read using the EnerVista 745 Setup software.
- ▷ Read the RMS magnitude and the phase of the current signal in each phase of each winding. **Note that the Winding 1 Phase A current is used as the reference for all angle measurements.**

$$I_{\text{phase rms displayed}} = I_{\text{phase input}} \times \text{CT ratio for that winding}$$

The phase angle will be 0° for all phase currents if the same current is injected in all phase input CTs. Sequence components will be:

$$\begin{aligned}
 I_1 &= \text{CT Ratio} \times \frac{I_a + aI_b + a^2I_c}{3} = 0, \text{ all 3 currents in phase, and } a = \angle 120^\circ \\
 I_2 &= \text{CT Ratio} \times \frac{I_a + a^2I_b + aI_c}{3} = 0, \text{ the 3 currents are in phase} \\
 I_{\text{zero-sequence}} &= \text{CT Ratio} \times \text{input current} \\
 I_{\text{neutral}} &= 3 \times \text{CT Ratio} \times \text{input current} \\
 I_{\text{ground}} &= \text{Ground CT Ratio} \times \text{input current into Ground CT}
 \end{aligned}
 \tag{EQ 7.1}$$

Since the transformer load is calculated using the maximum current from phases A, B, or C, the displayed load should be:

$$\% \text{ Loading} = \frac{\text{Actual Current}}{\text{Rated MVA Current}} \times 100\%$$

$$\text{where Rated MVA Current} = \frac{\text{MVA}}{\sqrt{3}kV_{L-L}} \quad (\text{EQ 7.2})$$

- ▷ Verify the harmonic content display in [A2 METERING ▷ HARMONIC CONTENT ▷ THD ▷ W1...W2...W3](#).
It should be zero or equal to distortion of input current.
- ▷ Verify frequency shown in [A2 METERING ▷ FREQUENCY ▷ SYSTEM FREQUENCY](#).
It should be 60 or 50 Hz, as per frequency of input current on Phase A.
- ▷ To verify the positive and negative sequence component values, apply the current signal to Phase A of each winding in series.
Read the values of positive and negative sequence current displayed by the relay.

$$I_1 = \frac{1}{3} \times \text{CT Ratio} \times (I_a + aI_b + a^2I_c) = \frac{1}{3} \times \text{CT Ratio} \times I_a \quad \text{since } I_b = I_c = 0$$

where $a = 1 \angle 120^\circ$ (EQ 7.3)

$$I_2 = \frac{1}{3} \times \text{CT Ratio} \times (I_a + a^2I_b + aI_c) = \frac{1}{3} \times \text{CT Ratio} \times I_a \quad \text{since } I_b = I_c = 0$$

(EQ 7.4)

All angles will be 0° . These values are displayed in the [A2 METERING ▷ CURRENT ▷ POSITIVE SEQUENCE ▷ W1...W2...W3](#) and [A2 METERING ▷ CURRENT ▷ NEGATIVE SEQUENCE ▷ W1...W2...W3](#) actual values menus.

- ▷ Lower the current amplitude while displaying the system frequency.
- ▷ Verify that the frequency is displayed correctly with current levels down to approximately 50 mA RMS input.
- ▷ Decrease current to 0 A.

7.4.3 Voltage Input

- ▷ Connect an AC voltage to the voltage input (if the input voltage feature is enabled) to terminals C11 and C12.
- ▷ Set the level at the expected VT secondary voltage on the VT for your installation.
- ▷ Remove all current signals from the relay.
- ▷ Verify the voltage reading in [A2 METERING ▷ VOLTAGE ▷ SYSTEM LINE-TO-LINE VOLTAGE](#).
The reading should be equal to the input voltage \times VT ratio.



The displayed system voltage is always the line-to-line voltage regardless of the input VT signal. Earlier versions of the 745 may display the same voltage as the selected input, i.e. phase-to-neutral if the input is a phase-to-neutral signal and phase-to-phase if the input is phase-to-phase.

- ▷ With the voltage signal still ON, read the displayed system frequency under **A2 METERING ▷ ▾ FREQUENCY ▷ SYSTEM FREQUENCY**.
- ▷ Lower the voltage amplitude while displaying the system frequency.
- ▷ Verify that the frequency is displayed correctly with voltage levels down to less than 3 V RMS input (when the lower limit is reached, the system frequency will be displayed as 0.00 Hz).
- ▷ Verify that at less than 1.0 V, frequency is displayed as 0.00 Hz.

7.4.4 Transformer Type Selection

7.4.4.1 Description

The 745 automatically configures itself to correct for CT ratio mismatch, phase shift, etc., provided that the input CTs are all connected in wye. The following example illustrates the automatic setting feature of the 745.

7.4.4.2 Automatic Transformation

The automatic configuration routines examine the CT ratios, the transformer voltage ratios, the transformer phase shift, etc., and apply correction factors to match the current signals under steady state conditions.

Consider the case of a Y:D30° power transformer with the following data (using a 1 A CT secondary rating for the relay):

- Winding 1: 100 MVA, 220 kV, 250/1 CT ratio (rated current is 262.4 A, hence CT ratio of 250/1)
- Winding 2: 100 MVA, 69 kV, 1000/1 CT ratio (rated current is 836.8 A, hence CT ratio of 1000/1)

The 1000/1 CT ratio is not a perfect match for the 250/1 ratio. The high-side CT produces a secondary current of $262.5/250 = 1.05$ A whereas the low-side CT produces a current of 0.837 A. The 745 automatically applies an amplitude correction factor to the Winding 2 currents to match them to the Winding 1 currents. The following illustrates how the correction factor is computed:

$$CT_2(\text{ideal}) = CT_1 \times \frac{V_1}{V_2} = \frac{250}{1} \times \frac{220 \text{ V}}{69 \text{ V}} = 797.1 \quad (\text{EQ 7.5})$$

The mismatch factor is therefore:

$$\frac{\text{Ideal CT Ratio}}{\text{Actual CT Ratio}} = \frac{797.1}{1000} = 0.7971 \quad (\text{EQ 7.6})$$

Winding 2 currents are divided by this factor to obtain balanced conditions for the differential elements.

If this transformer were on line, fully loaded, and protected by a properly set 745 relay, the actual current values read by the relay would be:

- Winding 1: 262.5 A $\angle 0^\circ$ (this is the reference winding)
- Winding 2: 836.8 A $\angle 210^\circ$ (30° lag due to transformer and 180° lag due to CT connections)

- Differential current: $< 0.03 \times \text{CT}$ as the two winding currents are equal once correctly transformed inside the relay.
- The loading of each winding would be 100% of rated.

The above results can be verified with two adjustable sources of three-phase current. With a single current source, how the relay performs the necessary phase angle corrections must be taken into account. Table 5-1: *Transformer types* on page 5-13 shows that the Y-side currents are shifted by 30° to match the Delta secondary side. The 30° phase shift is obtained from the equations below:

$$I_{W1a'} = \frac{I_{W1a} - I_{W1c}}{\sqrt{3}}, \quad I_{W1b'} = \frac{I_{W1b} - I_{W1a}}{\sqrt{3}}, \quad I_{W1c'} = \frac{I_{W1c} - I_{W1b}}{\sqrt{3}} \quad (\text{EQ 7.7})$$

By injecting a current into Phase A of Winding 1 and Phase A of Winding 2 only, $I_{W1b} = I_{W1c} = 0$ A. Therefore, if we assume an injected current of $1 \times \text{CT}$, the *transformed* Y-side currents will be:

$$I_{W1a'} = \frac{1 \times \text{CT}}{\sqrt{3}}, \quad I_{W1b'} = \frac{-1 \times \text{CT}}{\sqrt{3}}, \quad I_{W1c'} = \frac{0 \times \text{CT}}{\sqrt{3}} \quad (\text{EQ 7.8})$$

For the purposes of the differential elements only, the transformation has reduced the current to 0.57 times its original value into Phase A, and created an apparent current into Phase B, for the described injection condition. If a $1 \times \text{CT}$ is now injected into Winding 1 Phase A, the following values for the differential currents for all three phases should be obtained:

Phase A differential: $0.57 \times \text{CT} \angle 0^\circ$ Lag
 Phase B differential: $0.57 \times \text{CT} \angle 180^\circ$ Lag
 Phase C: $0 \times \text{CT}$.

7.4.4.3 Effects of Zero-sequence Compensation Removal



The transformation used to obtain the 30° phase shift on the Y-side automatically removes the zero-sequence current from those signals. The 745 always removes the zero-sequence current from the delta winding currents.

If the zero-sequence component is removed from the Delta-side winding currents, the Winding 2 current values will change under unbalanced conditions. Consider the case described above, with the $1 \times \text{CT}$ injected into Phase A of Winding 2.

For the $1 \times \text{CT}$ current, the zero-sequence value is $1/3$ of $1.0 \times \text{CT}$ or $0.333 \times \text{CT}$ A. The value for $I_{W2a'}$ is therefore $(1.0 - 0.333) \times \text{CT} = 0.667 \times \text{CT}$ A. This value must be divided by the CT error correction factor of 0.797 as described above.

Therefore, the value of differential current for Phase A, when injecting $1 \times \text{CT}$ in Winding 2 only, is:

$$I_{A(\text{differential})} = \frac{0.667 \times \text{CT A}}{0.797} = 0.84 \times \text{CT A} \quad (\text{EQ 7.9})$$

The action of removing the zero-sequence current results in a current equal to the zero-sequence value introduced into phases B and C. Hence, the differential current for these two elements is:

$$I_{B(\text{differential})} = I_{C(\text{differential})} = \frac{0.333 \times \text{CT A}}{0.797} = 0.42 \times \text{CT A} \quad (\text{EQ 7.10})$$

Now, applying $1 \times CT$ into Winding 1 Phase A and the same current into Phase A Winding 2, but 180° out-of-phase to properly represent CT connections, the total differential current in the Phase A element will be $(0.57 - 0.84) \times CT = -0.26 \times CT$. The injection of currents into Phase A of Windings 1 and 2 in this manner introduces a differential current of $(-0.57 \times CT + 0.42 \times CT) = -0.15 \times CT$ into Phase B and $(0.0 \times CT + 0.42 \times CT) = 0.42 \times CT$ into Phase C.

7.4.5 Ambient Temperature Input

7.4.5.1 Basic Calibration of RTD Input

- ▷ Enable ambient temperature sensing with the [S2 SYSTEM SETUP ▷▽ AMBIENT TEMP ▷ AMBIENT TEMPERATURE SENSING](#) setpoint.
- ▷ Connect a thermocouple to the relay terminals B10, B11, and B12 and read through the [A2 METERING ▷▽ AMBIENT TEMP ▷ AMBIENT TEMPERATURE](#) actual value.
- ▷ Compare the displayed value of temperature against known temperature at the location of the sensor.
Use a thermometer or other means of obtaining actual temperature.

An alternative approach is to perform a more detailed calibration per the procedure outlined below.

7.4.5.2 Detailed Calibration of RTD Input

1. Alter the following setpoints. Set [S2 SYSTEM SETUP ▷▽ AMBIENT TEMP ▷ AMBIENT TEMPERATURE SENSING](#) to **Enabled** and set [S2 SYSTEM SETUP ▷▽ AMBIENT TEMP ▷▽ AMBIENT RTD TYPE](#) to the desired type.
The measured values should be $\pm 2^\circ\text{C}$ or $\pm 4^\circ\text{F}$.
2. Alter the resistance applied to the RTD input (note the 3-input connection must be used for the measurements to be valid) as per the *typical* table below to simulate RTDs and verify accuracy of the measured values.
3. View the measured values in [A2 METERING ▷▽ AMBIENT TEMP ▷ AMBIENT TEMPERATURE](#).

Refer to RTD tables included in this manual for calibration of resistance versus temperature.

Table 7-1: Measured RTD temperature

RTD type	100 Ω Platinum resistance	Expected RTD reading		Measured RTD temperature ____ $^\circ\text{C}$ ____ $^\circ\text{F}$ (select one)
		$^\circ\text{C}$	$^\circ\text{F}$	
100 Ω Platinum	80.31	-50	-58	
	100.00	0	32	
	119.39	50	122	
	138.50	100	212	
	157.32	150	302	
	175.84	200	392	
	194.08	250	482	

Table 7-1: Measured RTD temperature

RTD type	100 Ω Platinum resistance	Expected RTD reading		Measured RTD temperature ____°C ____°F (select one)
		°C	°F	
120 Ω Nickel	86.17	-50	-58	
	120.0	0	32	
	157.74	50	122	
	200.64	100	212	
	248.95	150	302	
	303.46	200	392	
	366.53	250	482	
100 Ω Nickel	71.81	-50	-58	
	100.00	0	32	
	131.45	50	122	
	167.20	100	212	
	207.45	150	302	
	252.88	200	392	
	305.44	250	482	

7.4.5.3 Ambient Temperature by Monthly Averages

- ▷ If the ambient temperature is entered as 12 monthly averages, program the value for the month during which the relay is being commissioned.
- ▷ Examine the **A2 METERING ▷▽ AMBIENT TEMP ▷ AMBIENT TEMPERATURE** actual value to verify the programmed temperature.
- ▷ Verify that values entered for other months do not affect the value for the present month.

7.4.6 Analog outputs

The analog output settings are located in the **S2 SYSTEM SETUP ▷▽ ANALOG OUTPUTS** setpoints section.

- ▷ Connect a milliammeter to the analog output contacts: COM on A5 and analog output 1 on A6, analog output 2 on A7, analog output 3 on A8, analog output 4 on A9, analog output 5 on A10, analog output 6 on A11, or analog output 7 on A12.
- ▷ From the settings used for the tested analog output, determine the mA range for the output and the driving signal and its range for the full range of output current.
- ▷ Apply the input signal and vary its amplitude over the full range and ensure the analog output current is the correct amplitude.
- ▷ Record the results in the table below.
- ▷ Duplicate as required for each analog output.

Table 7-2: Analog Output Calibration Results

Analog output number: _____ Analog output minimum: _____ Analog output value: _____ Analog output maximum: _____ Analog output range: _____		
Input signal amplitude (% of full range)	Expected mA output	Measured mA output
0		
25		
50		
75		
100		

7.4.7 Tap Position

The analog input used to sense tap position is programmed with the [S2 SYSTEM SETUP](#) [ONLOAD TAP CHANGER](#) setpoints.

- ▷ To verify the operation of this circuit, connect a variable resistor across terminals A3 and A4.
The resistor range should cover the full range of resistance produced by the tap changer mechanism. The tap position is displayed in [A2 METERING](#) [TAP CHANGER](#) [TAP CHANGER POSITION](#).
- ▷ Adjust the resistance to simulate the minimum tap position and verify that a “1” is displayed.
- ▷ Gradually increase the resistance up to the value which represents the maximum tap value, verifying that the tap position indicator tracks the resistance.

7.5 Protection Schemes

7.5.1 Precaution



Keep track of modifications/changes made to settings during the course of these commissioning steps and ensure that all settings are returned to the 'in-service' values at the end of the tests.

7.5.2 Harmonic Restrained Percent Differential

7.5.2.1 Description

The harmonic restrained percent differential element setpoints are located in [S4 ELEMENTS > DIFFERENTIAL > PERCENT DIFFERENTIAL](#). Disable all other protection elements to ensure that trip relay(s) and auxiliary relays are operated by element under test only. With a multimeter, monitor the appropriate output contact(s) per intended settings of the FlexLogic™. Refer to the relay settings to find out which relay(s) should operate when a given element operates.

7.5.2.2 Minimum Pickup

The minimum pickup of the phase A element is measured by applying a fundamental frequency AC current to terminals H1 and G1, winding 1 phase A. Monitor the appropriate trip and auxiliary contact(s) as the current is increased from 0 A. Compare the current value at which operation is detected against the [S4 ELEMENTS > DIFFERENTIAL > PERCENT DIFFERENTIAL > PERCENT DIFFERENTIAL PICKUP](#) setpoint. Since the operating point is normally set quite low, fine control of the current signal will be required to obtain accurate results.

The currents in the winding may be phase shifted or may have the zero-sequence component removed due to auto-configuration (see *Auto-configuration* on page 5–6). As an alternate to calculating to relation of input current to differential current, the differential current is displayed in [A2 METERING > CURRENT > DIFFERENTIAL](#). Ensure that the displayed value is the same as the minimum pickup setting when the element operates.

- ▷ Check that the Trip and Message LEDs are flashing and one of the following trip messages is displayed:

LATCHED a: Percent Differential, or OPERATED a: Percent Differential



The above messages will indicate either **OPERATED** or **LATCHED** depending on the [S4 ELEMENTS > DIFFERENTIAL > PERCENT DIFFERENTIAL > PERCENT DIFFERENTIAL TARGET](#) setting.

To independently verify that auto-configuration causes the currents to be as measured, follow the rules outlined in the steps below.

- ▷ Look up transformer type in Table 5–1: *Transformer types* on page 5–13.

- ▷ For the phase shift for the particular set of vectors, determine the processing applied to the current vectors for that winding from Table 5–2: *Phase shifts* on page 5–24.
- ▷ Calculate the “dashed” current values using the equations in Table 5–2: *Phase shifts* on page 5–24.
If applicable, use the zero-sequence removal computation. This is applicable for all Delta windings and for both windings of a wye-wye transformer. Compute the processed current vectors to obtain the “dashed” values for that winding.
- ▷ Calculate the CT correction factor for windings 2 (and 3 if applicable) and apply as necessary.
- ▷ Turn the equations around to compute the threshold differential currents in terms of the applied currents.
- ▷ To check the threshold without performing computations, inject balanced 3-phase currents into any winding.
With balanced conditions, there is no effect on magnitude due to phase shifting and zero-sequence removal has no effect. However, the CT ratio mismatch is still applicable.
- ▷ Repeat the minimum pickup level measurements for the Phase B (inputs H2 and G2) and the Phase C element (inputs H3 and G3).



NOTE

The above tests have effectively verified the minimum operating level of the three harmonic restrained differential elements. If desired the above measurements may be repeated for the phase inputs for the other winding(s). The results should be identical.

7.5.2.3 Verification of Local Reset Mode

- ▷ Set the differential element with a latched target.
- ▷ Apply enough current to cause the relay to operate, then remove the current.
The Trip LED and the Phase LED should be latched on.
- ▷ Set **S1 745 SETUP ▷ ▾ RESETTING ▷ LOCAL RESET BLOCK** to **Disabled**.
- ▷ Press the **RESET** key. The target should reset.
- ▷ Set **S1 745 SETUP ▷ ▾ RESETTING ▷ LOCAL RESET BLOCK** to **Logic Input 1(16)**.
- ▷ Press the **RESET** key and verify that the target does not reset if the logic input is not asserted.
- ▷ Verify the status of selected logic input through the **A1 STATUS ▷ ▾ LOGIC INPUTS ▷ ▾ LOGIC INPUT 1(16) STATE** actual value.
- ▷ Assert the selected logic input, apply the current to cause the target to latch and verify that pressing the **RESET** button does not reset the LED. The following message should appear: **INVALID KEY: MUST BE IN LOCAL MODE**.

7.5.2.4 Verification of Remote Reset Mode

- ▷ Set the differential element with a latched target.
- ▷ Apply enough current to cause the relay to operate, then remove the current.
The Trip LED and the Phase LED should be latched on.
- ▷ Set **S1 745 SETUP ▷ ▾ RESETTING ▷ ▾ REMOTE RESET SIGNAL** to **Logic Input 1(16)**.
- ▷ Assert logic input 1.
The target should reset.

7.5.2.5 Verification of Solid-state Output

If the solid-state Output Is Used To Drive Auxiliary Relays,

- ▷ Verify that these relays operate whenever the relay is in a trip condition.
- ▷ Ensure that the current through the auxiliary coils is interrupted by an external contactor between each test.

To avoid operating the breaker during the commissioning process when the solid-state output operates the breaker directly,

- ▷ Use the circuit shown below to verify this output.
Whenever the relay is in a trip state, current flows through the load resistor.
- ▷ Select the resistor for approximately $1 \times CT$ of DC current with the normal DC supply voltage used in your relay scheme.

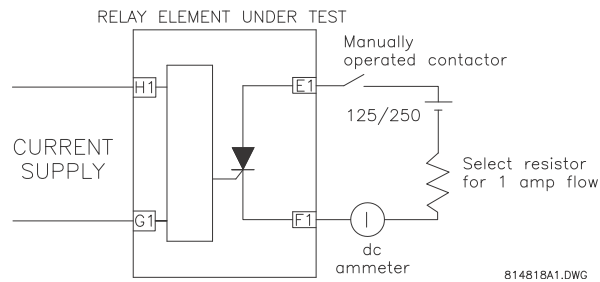

FIGURE 7-4: Solid-state output test circuit

7.5.2.6 Basic Operating Time

To measure the basic operating time of the harmonic restrained differential elements,

- ▷ Connect an AC current signal to terminals H1 and G1, through a double-pole single-throw switch.
The second pole of the switch starts a timer circuit which is stopped by the operation of the relay trip contact. Refer to the figure below for details.
- ▷ Close the switch and set the current level to three (3) times the minimum pickup value measured earlier.

- ▷ Re-open the switch and reset all targets on the relay.
- ▷ Ensure that timer circuit functions correctly.
- ▷ Close the switch and record operating time of relay.

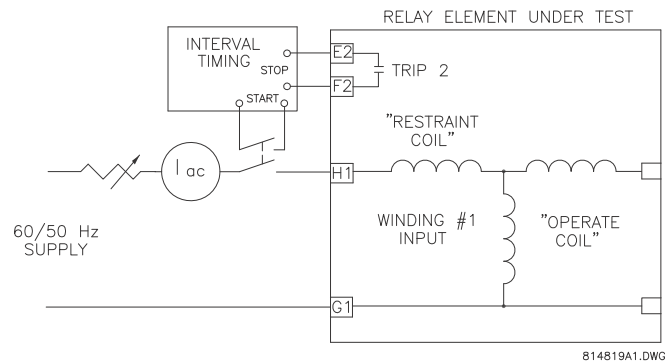

FIGURE 7-5: Timer test circuit

7.5.2.7 Slope Measurements

The auto configuration processes the currents to correct for phase shifts, CT mismatch, and zero sequence component removal. As such, it more complex to measure the slope from an external single phase injection. Therefore, the use of displayed actual values is recommended.

The differential and restraint currents are displayed the [A2 METERING ▷ CURRENT ▷ ▷ DIFFERENTIAL ▷ PHASE A DIFFERENTIAL CURRENT](#) and [A2 METERING ▷ CURRENT ▷ ▷ RESTRAINT ▷ PHASE A RESTRAINT CURRENT](#) actual values:

To measure the slope,

- ▷ Connect current signals to the relay as shown in the figure below:

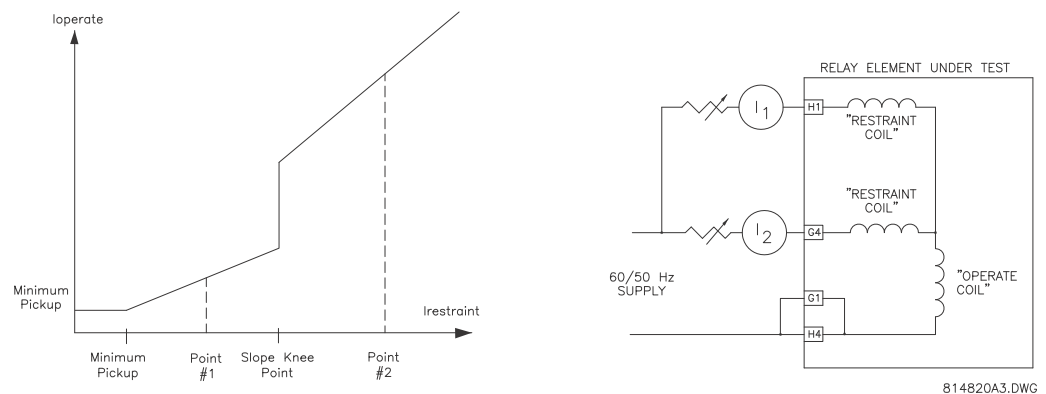

FIGURE 7-6: Current signal connections

If $I_1 = 1.5 \times CT$ and $I_2 = 0$, the element is operated as all the current appears as a differential current.

The slope is calculated from the values of $I_{differential}$ and $I_{restraint}$ as follows:

$$\%slope = \frac{I_{differential}}{I_{restraint}} \times 100\%$$

- ▷ Slowly increase I_2 . As I_2 is increased, the element will reset when the differential current drops below the minimum pickup.

As I_2 continues to increase, the element operates again when both the initial slope and the minimum pickup conditions are satisfied.

- ▷ Calculate the initial slope 1 value at this point.

As I_2 increases further, the element may reset again, depending on the setting of the slope kneepoint. This is caused by the current values moving into the slope 2 region.

- ▷ Continue increasing I_2 until the element operates again.
- ▷ Compute the slope 2 value at this point.

7.5.2.8 Slope Kneepoint

- ▷ To measure the approximate kneepoint location, follow the procedure above, setting I_1 equal to the kneepoint.
- ▷ Gradually increase I_2 until the element resets.
- ▷ Calculate the first slope at this point.
This value should be equal to the initial slope setting.
- ▷ Increase I_2 until the element operates again.
- ▷ Calculate the slope at this point.
It should be equal to the final slope.
If the kneepoint is much different than the selected value of I_1 , the two values of slope will be the same.
- ▷ For an accurate measurement of the kneepoint, select a value of I_1 just above the kneepoint value.
- ▷ Increase I_2 until the element resets.
- ▷ Calculate the slope.
The value should be equal to the initial slope value.
- ▷ Increase I_1 by a small amount, say 10%, and adjust I_2 until a new operating point is obtained.
- ▷ Calculate the slope.
- ▷ Repeat until the slope value equals the final slope.
The kneepoint value is the value of the restraint current at which the slope changed in value.



Keep in mind the effects of auto-configuration on the magnitude of the current signal fed to the differential elements when conducting the slope kneepoint test.

7.5.2.9 Second Harmonic Restraint

To measure the percentage of second harmonic required to block the operation of the harmonic-restraint differential elements, use the connection diagram shown below. Current is supplied as an operating current to the phase A element.

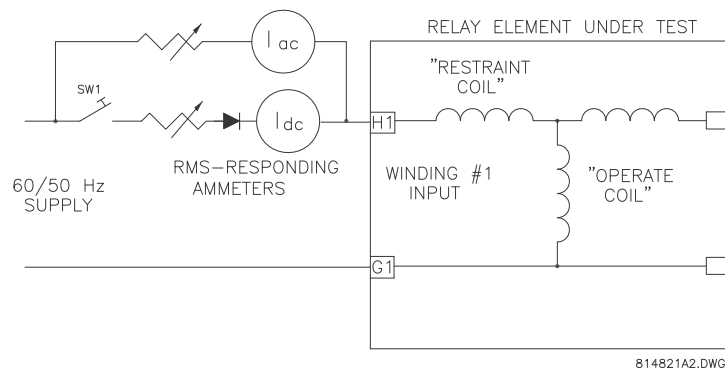

FIGURE 7-7: Second harmonic restraint testing

- ▷ Close switch S1. Set the AC current, I_{AC} to $2 \times$ rated CT secondary. Set I_{DC} to obtain harmonic content above the 2nd harmonic restraint setting under **S4 ELEMENTS ▷ ▽ DIFFERENTIAL ▷ ▽ HARMONIC INHIBIT ▷ ▽ HARMONIC INHIBIT LEVEL**.
- ▷ Calculate the percent second harmonic content from the following equations. If the current is measured with average-responding/reading meters:
 - ▷
$$\%2nd = \frac{100 \times 0.424 \times I_{DC}}{I_{DC} + 0.9 \times I_{AC}}$$
- ▷ If the current is measured with RMS-responding/reading meters, then:
 - ▷
$$\%2nd = \frac{100 \times 0.424 \times I_{DC}}{I_{DC} + 1.414 \times I_{AC}}$$
- ▷ Open and reclose S1. The relay should not operate.
- ▷ Decrease I_{DC} until the element operates. Calculate the percent of second harmonic at this point using the equations above. The calculated percent harmonic value should equal the relay setting.

7.5.2.10 Fifth Harmonic Restraint

Verifying the operation of the 5th harmonic restraint requires test equipment capable of generating a current signal containing a fundamental and 5th harmonic. Most modern dedicated relay test instruments, such as Powertec's (or Manta) DFR, Doble, or MultiAmp instruments are capable of generating appropriate signals. A power operational amplifier with a suitably rated output, or a power audio amplifier, may also be used to generate the appropriate signal.

- ▷ Connect the test setup as below to supply the phase A element. Set the fundamental current level to the CT rated secondary value. The harmonic restraint differential element of phase A should be operated.

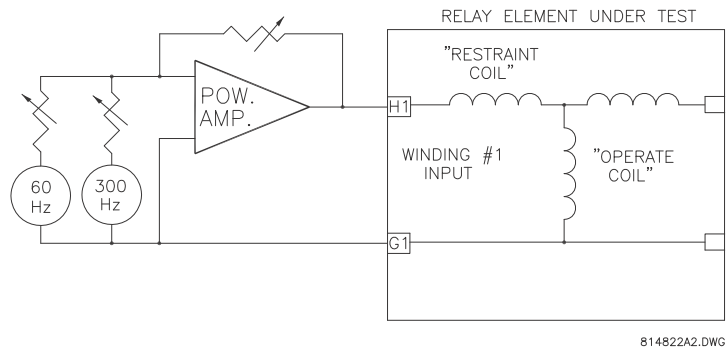

FIGURE 7-8: Fifth harmonic restraint testing

- ▷ Increase the 5th harmonic component to a value well above the **S4 ELEMENTS ▷ ▾ DIFFERENTIAL ▷ ▾ 5th HARM INHIBIT ▷ ▾ 5th HARMONIC INHIBIT LEVEL** setting.
- ▷ Remove the total current signal and reapply. The relay should not operate.
- ▷ Decrease the 5th harmonic component until the element operates.
- ▷ Calculate the percentage 5th harmonic to restrain from the following equation:

$$\%5th = \frac{100 \times \text{level of 5th harmonic}}{\text{level of fundamental}}$$
- ▷ Compare this value to the relay setting.

7.5.2.11 Energization Detection Scheme

Refer to *Differential Element* on page 5-48 for a description of this feature. This feature is activated by up to three inputs: breaker auxiliary switch, current below a threshold, or absence of voltage. The procedure below tests the current-level enabling feature. A similar approach can verify the other two enabling functions with the proper test equipment.

- ▷ Enable the Energization Detection Scheme by setting **S4 ELEMENTS ▷ ▾ DIFFERENTIAL ▷ ▾ ENERGIZATION INHIBIT ▷ ENERGIZATION INHIBIT FUNCTION** to **Enabled**.
- ▷ Make the following setpoint changes in the **S4 ELEMENTS ▷ ▾ DIFFERENTIAL ▷ ▾ ENERGIZATION INHIBIT** setpoints menu:
 - ENERGIZATION INHIBIT PARMETERS:** "2nd"
 - HARMONIC AVERAGING:** "Disabled"
 - ENERGIZATION INHIBIT LEVEL:** "15%"
 - ENERGIZATION INHIBIT DURATION:** "5 s"
 - ENERGIZATION SENSING BY CURRENT:** "Enabled"
 - ENERGIZATION INHIBIT/MINIMUM ENERGIZATION CURRENT:** "0.10 × CT"
- ▷ Preset current with harmonic content just above the **ENERGIZATION INHIBIT LEVEL** used during the 'energization period'.

- ▷ Apply the current signal and measure the operating time. The time should be equal to 'energization period' plus approximately 50 ms.
- ▷ Disable the energization detection scheme and repeat the timing test. The operate time should be the normal operating time of harmonic restraint differential element.

7.5.2.12 Target, Output, Contact, And Display Operation

- ▷ Verify the correct operation of all targets, output contacts, and display messages during the percent differential tests above.

7.5.2.13 Blocking from Logic Inputs

Each element can be programmed to be blocked by a logic input, virtual input, virtual output, output relay operation, or self-test relay operation. This procedure verifies that the differential element is blockable by logic input 1.

- ▷ Select logic input 1 by setting the **S4 ELEMENTS ▷ ▾ DIFFERENTIAL ▷ PERCENT DIFFERENTIAL ▷ ▾ PERCENT DIFFERENTIAL BLOCK** setpoint to **Logic Inpt 1**.
- ▷ Apply current to operate the differential element then assert logic input 1.
- ▷ Verify that the element has reset and that all targets can be reset.
- ▷ With logic input 1 asserted, remove the current and reapply.
- ▷ Verify that the element did not operate.

7.5.3 Instantaneous Differential Protection

7.5.3.1 Overview

Settings for this element are under the **S4 ELEMENTS ▷ ▾ INST DIFFERENTIAL** setpoints group. All other protective elements must be disabled to ensure that trip relay(s) and auxiliary relays are operated by element under test. Monitor the appropriate contact per intended settings of the FlexLogic™.

7.5.3.2 Minimum Pickup

The operating level of the phase A element is measured by applying an AC current to terminals H1 and G1. Monitor the appropriate trip and auxiliary contact(s) as the current is increased from 0 A. Due to the auto-configuration feature, it may be easier to read the actual differential current on the relay rather computing it.

- ▷ Compare the value of the differential current at which operation is detected against the **S4 ELEMENTS ▷ ▾ INST DIFFERENTIAL ▷ ▾ INST DIFFERENTIAL PICKUP** setpoint.

- ▷ Check that the Trip and Message LEDs are flashing and the following trip message is displayed:

LATCHED a (bc) Inst Differential.



The message may show **OPERATED** instead of **LATCHED** if the **TARGET** setpoint is “**Self-Reset**”.

NOTE

7.5.3.3 Operating Time

To measure the basic operating time of the instantaneous differential elements,

- ▷ Connect an AC current signal to terminals H1 and G1 through a double-pole, single-throw switch.
The second pole of the switch starts a timer circuit that will be stopped by the operation of the relay trip contact. Refer to **FIGURE 7-5: Timer test circuit** on page 7-19.
- ▷ Close the switch and set the current level to two times the pickup value measured earlier.
- ▷ Re-open the switch and reset all targets on the relay.
- ▷ Ensure that the timer circuit functions correctly.
- ▷ Close the switch and record operating time of relay.



All differential currents are calculated using the same principal shown in *Transformer Type Selection* on page 7-11. The differential current derivation is affected by phase shift compensation and zero sequence removal.

NOTE

7.5.3.4 Target, Output Contact, and Display Operation

- ▷ Verify the correct operation of all targets and output contacts and display messages during testing.

7.5.3.5 Blocking from Logic Inputs

Each element is programmable to be blocked by a logic input, virtual input, virtual output, output relay operation, or self-test relay operation. This test verifies that the differential element can be blocked by logic input 1.

- ▷ Select Logic Input 1 by setting the **S4 ELEMENTS ▷ ▾ DIFFERENTIAL ▷ PERCENT DIFFERENTIAL ▷ ▾ PERCENT DIFFERENTIAL BLOCK** setpoint to **Logic Inpt 1**.
- ▷ Apply current to operate the differential element then assert logic input 1.
- ▷ Verify that the element has reset and that all targets can be reset.
- ▷ With logic input 1 asserted, remove the current and reapply.
- ▷ Verify that the element did not operate.

7.5.4 Phase Time Overcurrent

7.5.4.1 Description

This procedure verifies that the phase time overcurrent element performance matches the in-service settings. Since these elements can have any one of a multitude of timing curves, a table of expected operating times versus applied current should be prepared prior to testing the elements. Refer to *Time Overcurrent Curves* on page 5–58 for information on timing curves.

If the relay elements are set for a “Linear” reset characteristic when measuring the operating times, ensure that there is sufficient time between test current injections for the element to reset fully; otherwise, erroneous timing measurements will be obtained. The settings for these elements are found in the [S4 ELEMENTS ▸ ▾ PHASE OVERCURRENT](#) setpoints page.

7.5.4.2 Winding 1 Elements

To ensure that only the phase time overcurrent elements operate the trip relays (and any other output relays) selected by the logic, disable all protection features except phase time overcurrent. Use the general test setup shown below:

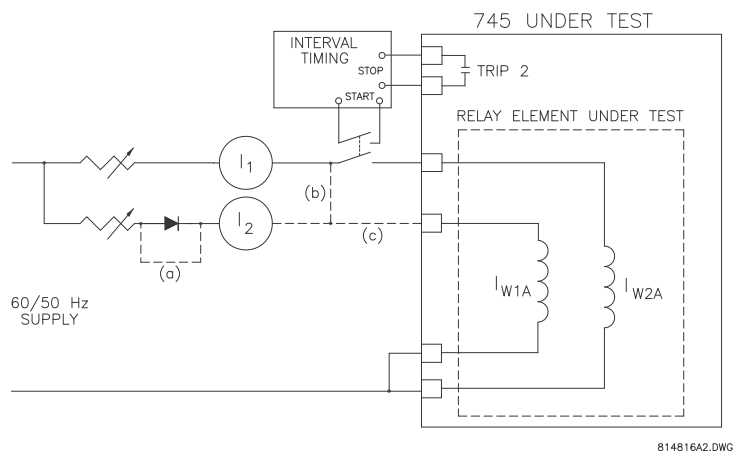

FIGURE 7-9: General test setup

Connect the current supply to terminals $X = H1$ and $Y = G1$ to test the winding 1 phase A element. Monitor the appropriate output relays per the FlexLogic™ settings or from assigned relay settings from Phase TOC.

7.5.4.3 Pickup Level

- With the interval timer disabled, apply the current signal and increase its magnitude slowly until the trip relay and all the selected auxiliary relays operate.

If the element has a very inverse time characteristic, it is easier and more accurate to increase the current far above the pickup level until the trip relay operates then reduce the current to just above the operate level. Then, current can be slowly reduced below the operate level and observed for a reset action on the trip relay. This reset level for the current should be approximately 98% of the pickup level.

- ▷ Once the relay drops out, slowly increase the current until the trip contact closes.
The operate level should correspond to the pickup setting.
- ▷ Check that one of the following messages is displayed:

LATCHED a: W1 Phase Time OC or **OPERATED a: W1 Phase Time OC**

The message will indicate **LATCHED** or **OPERATED**, depending on the setting for the target.

7.5.4.4 Operating Time

Using a table like the one shown below, select three (3) or four (4) values of current multiples at which the timing is to be measured.

- ▷ Enter the expected operating times from the timing curve applied in the settings.
- ▷ Using the setup shown in FIGURE 7-9: *General test setup* on page 7-25 and the Interval Timer enabled, set the current level to the desired value.
- ▷ Apply suddenly by closing the double-pole switch.
- ▷ Record the operating time.
- ▷ Compare this to the expected value.
- ▷ Repeat for all desired values of current.

Current multiple	Nominal time	Measured time
1.5		
3		
5		

7.5.4.5 Reset Time

A precise measurement of the reset time requires a relay test set capable of dynamic operation, with three sequenced stages, each with programmable current levels and time duration external contact, and flexible triggering. To perform such a test, please contact GE Multilin for detailed test instructions.

A simple verification the selected reset mode can be obtained using FIGURE 7-9: *General test setup* on page 7-25. The procedure consists of performing repetitive operating time measurements in quick succession. If the reset is selected for instantaneous, the operating time will always be equal to the nominal time derived from the selected curve. If the reset is selected as linear, the operating time will vary as a function of the time between successive application of the current signal. If performed at current multiples of 2 to 3 times the pickup level, the variations in operating time will be easier to detect.

7.5.4.6 Phase B and C Elements

If the Phase A element performed correctly and met specifications, repeat the pickup level portion of the above test for the B and C phases of winding 1. For Phase B, X = H2 and Y = G2. For phase C, X = H3 and Y = G3. The displayed message should change to indicate the correct phase, winding, and element that operated.

7.5.4.7 Winding 2 and 3 Elements

Because the winding 2 and 3 elements can be set with completely different parameters than the elements for winding 1, it is necessary to repeat the full set of tests described above for each winding.



The blocking from logic input, if enabled, can be tested as described in earlier tests for other elements.

NOTE

7.5.5 Phase Instantaneous Overcurrent 1

7.5.5.1 Description

This procedure verifies that the phase instantaneous overcurrent performance matches the in-service settings. The settings for these elements are found under the **S4 ELEMENTS >> PHASE OVERCURRENT** setpoints menu. The testing occurs at current multiples of at least five times the rated CT secondary value. *Do not leave the current signal on for more than a few seconds!*

7.5.5.2 Winding 1 elements

To ensure that only the phase instantaneous overcurrent 1 element operates the trip relays (and any other output relays) selected by the logic, disable all protection features except phase instantaneous overcurrent 1. Use the general test setup shown in FIGURE 7-9: *General test setup* on page 7-25.

Connect the current supply to terminals X = H1 and Y = G1 to test the winding 1 phase A element. Monitor the appropriate output relays as per the relay FlexLogic™ settings or assigned output relays from Phase IOC settings.

7.5.5.3 Pickup level

- ▷ With the interval timer disabled, apply the current signal and increase its magnitude until the trip relay (and all selected auxiliary relays) operate.
- ▷ Compare the measured operating level against the **S4 ELEMENTS >> PHASE OC >> W1 PHASE INST OC 1 >> W1 PHASE INST OC 1 PICKUP** setpoint.
- ▷ Check that Trip, Pickup, and Phase A(C) LEDs turn on when the element operates.
- ▷ Check that one of the following messages is displayed:

LATCHED a: W1 Phase Inst OC 1 or **OPERATED a: W1 Phase Inst OC 1**

- ▷ Reduce the current until the element resets.
The reset level should be 97% of the operate level. When the element resets, the Trip and Phase LEDs should remain on if the **W1 PHASE INST OC 1 TARGET** was selected as **Latched**. Otherwise, only the Trip LED should stay on.
- ▷ Reset indicators and clear messages.

7.5.5.4 Operating Time

- ▷ Using the setup shown in FIGURE 7–9: *General test setup* on page 7–25 and the Interval Timer enabled, set the current level to 1.5 times the operating level of the element.
- ▷ Apply current suddenly by closing the double-pole switch.
- ▷ Record the operate time and compare it to the **S4 ELEMENTS ▷ ▾ PHASE OC ▷ ▾ W1 PHASE INST OC 1 ▷ ▾ W1 PHASE INST OC 1 DELAY** setpoint value.

7.5.5.5 Phase B and C Elements

If the phase A element performed correctly and met specifications, repeat the pickup level portion of the above test for phases B and C of winding 1. For phase B, X = H2 and Y = G2. For phase C, X = H3 and Y = G3. The displayed message should change to indicate the correct phase, winding, and element that operated.

7.5.5.6 Winding 2 and 3 elements

Because the winding 2 and 3 elements can be set with completely different parameters than the winding 1 elements, it is necessary to repeat the full set of tests described above for each winding.

7.5.6 Phase Instantaneous Overcurrent 2

The phase instantaneous overcurrent 2 elements are identical to the phase instantaneous overcurrent 1 elements. As such, the same test procedure can be used to verify their correct operation. Disable all protection features except the phase instantaneous overcurrent 2 elements and follow the steps in the previous section, making the appropriate changes for the display indications and output relays which are operated by the phase instantaneous overcurrent 2 elements.



The blocking from logic input, if enabled, can be tested as described in earlier tests for other elements.

7.5.7 Neutral Time Overcurrent

7.5.7.1 Description

This procedure verifies that the neutral time overcurrent performance matches the in-service settings. Since these elements can have any one of a multitude of timing curves, a table of expected operating times versus applied current should be prepared prior to testing. The neutral element measures the derived zero-sequence current signal as an input. Refer to *Time Overcurrent Curves* on page 5–58 for information on timing curves.

If the relay elements are set for the “Linear” reset characteristic when measuring the operating times, ensure there is sufficient time between test current injections for the element to reset fully. Otherwise, erroneous timing measurements will be obtained.

The settings for these elements are found under the **S4 ELEMENTS ▷ ▾ NEUTRAL OC** setpoints menu. Note that there can only be one or two Neutral Time Overcurrent elements in service at the same time.

7.5.7.2 Winding 1 Element

To ensure that only the neutral time overcurrent element under test operates the trip relays (and any other output relays) selected by the logic, disable all protection features except neutral time overcurrent. Use the general test setup shown in FIGURE 7-9: *General test setup* on page 7–25.

Connect the current supply to terminals X = H1 and Y = G1 to test the winding 1 neutral element. Monitor the appropriate output relays as per the relay FlexLogic™ settings or assigned relays from phase IOC2 page.

7.5.7.3 Pickup Level

- ▷ With the interval timer disabled, apply the current signal and slowly increase its magnitude until the trip relay (and all the selected auxiliary relays) operate.

If the relay under test has a very inverse time characteristic, it is easier and more accurate to increase the current far above the pickup level until the trip relay operates, then reduce the current to just above the expected operate level.

- ▷ Slowly reduce the current below the operate level and observe for a reset action on the trip relay.
This current reset level should be approximately 98% of the pickup level setting. Once the relay drops out, *slowly* increase the current until the trip contact closes. The operate level should correspond to the **S4 ELEMENTS ▷ ▾ NEUTRAL OC ▷ W1 NTRL TIME OC ▷ ▾ W1 NEUTRAL TIME OC PICKUP** setpoint: Since current is being introduced into one phase only, the input current signal is equal to the $3I_0$ signal used by the element.
- ▷ When the element operates, check that the Trip, Pickup, and Phase LEDs are on and one of the following messages is displayed:

LATCHED a: W1 Ntrl Time OC or **OPERATED a: W1 Ntrl Time OC**

- ▷ Reduce the current until the element resets.
The reset level should be 97% of the operate level. When the element resets, the Trip and Message LEDs should remain on if the **W1 NEUTRAL TIME OC TARGET** was selected as **Latched**. Otherwise only the Trip LED remains on.
- ▷ Reset indicators and clear messages.

7.5.7.4 Operating Time

- ▷ Using a table like the one shown below, select three (3) or four (4) values of current multiples at which timing is to be measured.
- ▷ Enter the expected operating times from the timing curve applied in the settings.
- ▷ Using the setup in FIGURE 7-9: *General test setup* on page 7-25 and the interval timer enabled, set the current level to the desired value and apply suddenly by closing the double-pole switch.
- ▷ Record the operate time and compare to the expected value.
- ▷ Repeat for all desired values of current.

Current multiple	Nominal time	Measured time
1.5		
3		
5		

7.5.7.5 Reset Time

A precise measurement of the reset time requires a relay test set capable of dynamic operation, with three sequenced stages, each with programmable current levels and time duration, and flexible external contact triggering. To perform such a test, contact GE Multilin for detailed test instructions.

A simple verification of the reset mode selected by **S4 ELEMENTS ▷ ▾ NEUTRAL OC ▷ W1 NTRL TIME OC ▷ ▾ W1 NEUTRAL TIME OC RESET** is obtained using the setup shown in FIGURE 7-9: *General test setup* on page 7-25. The test consists of repetitive operating time measurements in quick succession. If the reset is set for “Instantaneous”, the operating time is always equal to the nominal time derived from the selected curve. If the reset is set as “Linear”, the operating time varies as a function of the time between successive applications of current. The variations in operating time are easier to detect if this test is performed at current multiples of 2 to 3 times the pickup level.

7.5.7.6 Winding 2 or 3 Elements

Since the winding 2 and 3 elements can be set with completely different parameters than the winding 1 elements, it is necessary to repeat the full set of tests described above for each winding.

- ▷ To test winding 2 elements, disable all protection elements except for **W2 NEUTRAL TIME OVERCURRENT**.

- ▷ Connect the current signal to X = H4 and Y = G4 and repeat tests in this section.
- ▷ To test winding 3 elements, disable all protection elements except for **W3 NEUTRAL TIME OVERCURRENT**.
- ▷ Connect the current signal to X = H7 and Y = G7 and repeat the tests in this section.



The blocking from logic input, if enabled, can be tested as described in earlier tests for other elements.

7.5.8 Neutral Instantaneous Overcurrent 1

7.5.8.1 Description

This procedure verifies that the neutral instantaneous overcurrent performance is as per the in-service settings. Settings for these elements are found under the **S4 ELEMENTS ▷ ▽ NEUTRAL OC ▷ ▽ W1 NTRL INST OC 1** setpoints menu. If the relay settings require testing at current multiples of several times the rated CT secondary value, *do not leave the current signal on for more than a few seconds*.

7.5.8.2 Winding 1 Element

To ensure that only the neutral instantaneous overcurrent 1 element operates the trip relays (and any other output relays) selected by the logic,

- ▷ Disable all protection features except neutral instantaneous overcurrent 1. Use the general test setup shown in FIGURE 7–9: *General test setup* on page 7–25.
- ▷ Connect the current supply to terminals X = H1 and Y = G1 to test the winding 1 phase A element.
- ▷ Monitor the appropriate output relays as per the relay FlexLogic™ settings or assigned relay settings.

7.5.8.3 Pickup level

- ▷ With the interval timer disabled, apply the current signal and increase its magnitude until the trip relays (and all the selected auxiliary relays) operate.
- ▷ Compare the measured operating level against the **S4 ELEMENTS ▷ ▽ NEUTRAL OC ▷ ▽ W1 NTRL INST OC 1 ▷ ▽ W1 NEUTRAL INST OC 1 PICKUP** value.
- ▷ Check that, when the element operates, the Trip and Pickup LEDs are on and one of the following messages is displayed:

LATCHED a: W1 Ntrl Inst OC 1 or **OPERATED a: W1 Ntrl Inst OC 1**

- ▷ Reduce the current until the element resets.
The reset level should be 97% of the operate level. When the element resets, the Trip and Message LEDs should remain on if the **W1 NEUTRAL INST OC 1 TARGET** was selected as “Latched”. Otherwise only the Trip LED should stay on.
- ▷ Reset indicators and clear messages.

7.5.8.4 Operating Time

- ▷ With the setup shown in FIGURE 7–9: *General test setup* on page 7–25 and the interval timer enabled, set the current level to 1.5 times the operate level of the element and apply suddenly by closing the double-pole switch.
- ▷ Record the operate time and compare to the **S4 ELEMENTS ▷ ▾ NEUTRAL OC ▷ ▾ W1 NTRL INST OC 1 ▷ ▾ W1 NEUTRAL INST OC 1 DELAY** value.

7.5.8.5 Winding 2 and 3 elements

Because the winding 2 and 3 elements can be set with completely different parameters than the winding 1 elements, it is necessary to repeat the full set of tests described in this section for each winding.



Only two neutral instantaneous overcurrent 1 elements can be in service simultaneously.



The blocking from logic input, if enabled, can be tested as described in earlier tests for other elements.

7.5.9 Neutral Instantaneous Overcurrent 2

The neutral instantaneous overcurrent 2 elements are identical to the neutral instantaneous overcurrent 1 elements. Consequently, the same test procedure can be used to verify their correct operation. Disable all protection features except neutral instantaneous overcurrent 2 and follow the steps in the previous section, making the appropriate changes for the LEDs and output relays operated by the neutral instantaneous overcurrent 2 elements.

7.5.10 Ground Time Overcurrent

7.5.10.1 Description

This procedure verifies that the ground time overcurrent performance matches the in-service settings. Since these elements can be assigned a multitude of timing curves, a table of expected operating times versus applied current should be prepared prior to testing. The ground element measures the current signal connected to the ground current input CT, H10 and G10 or F12 and E12. Refer to *Time Overcurrent Curves* on page 5–58 for information on timing curves. There can only be one or two ground time overcurrent

elements in service at the same time.

If the relay elements are set for the “Linear” reset characteristic when measuring the operating times, ensure there is sufficient time between test current injections for the element to reset fully. Otherwise, erroneous timing measurements will be obtained. The settings for these elements will be found under the [S4 ELEMENTS ▾ ▾ GROUND OC ▾ W1 GND TIME OC](#) setpoints menu.

7.5.10.2 Winding 1 Element

To ensure that only the ground time overcurrent element operates the trip relays (and any other output relays) selected by the logic,

- ▷ Disable all protection features except ground time overcurrent. Use the general test setup shown in FIGURE 7–9: *General test setup* on page 7–25.
- ▷ Connect the current supply to terminals X = H10 and Y = G10 to test the winding 1 ground element.
- ▷ Monitor the appropriate output relays as per the relay FlexLogic™ settings or assigned relay settings.

7.5.10.3 Pickup Level

- ▷ With the interval timer disabled, apply the current signal and slowly increase its magnitude until the trip relay (and all the selected auxiliary relays) operate.

If the relay has a very inverse time characteristic, it is easier and more accurate to increase the current far above the pickup level until the trip relay operates and then reduce the current to just above the operate level. Then slowly reduce the current below the operate level and observe for a reset action on the trip relay. This reset level for the current should be approximately 98% of the pickup level. Once the relay drops out, *slowly* increase the current until the trip contact closes. The operate level should correspond to the [S4 ELEMENTS ▾ ▾ GROUND OC ▾ W1 GND TIME OC ▾ ▾ W1 GROUND TIME OC PICKUP](#) setpoint.

- ▷ When the element operates, check that the Trip, Ground, and Pickup LEDs are on and one of the following messages is displayed:
 - LATCHED a: W1 Gnd Time OC** or **OPERATED a: W1 Gnd Time OC**
- ▷ Reduce the current until the element resets. The reset level should be 97% of the operate level. When the element resets the Trip and Message LEDs should remain on if the [W1 GROUND TIME OC TARGET](#) was selected as **Latched**. Otherwise, only the Trip LED should remain on.
- ▷ Reset indicators and clear messages.

7.5.10.4 Operating Time

Using a table like the one shown below,

- ▷ Select three (3) or four (4) values of current multiples at which the timing is to be measured.

- ▷ Enter the expected operating times from the timing curve applied in the settings.
- ▷ Using FIGURE 7-9: *General test setup* on page 7-25 with the interval timer enabled, set the current level to the desired value and apply suddenly by closing the double-pole switch.
- ▷ Record the operate time and compare to the expected value.
- ▷ Repeat for the all the desired values of current.

Current multiple	Nominal time	Measured time
1.5		
3		
5		

7.5.10.5 Reset Time

A precise measurement of the reset time requires a relay test set capable of dynamic operation, with three sequenced stages, each with programmable current levels and time duration, and flexible external contact triggering. To perform such a test, contact GEGE Multilin for detailed test instructions.

A simple verification of the reset mode selected with the [S4 ELEMENTS ▷ ▾ GROUND OC ▷ W1 GND TIME OC ▷ ▾ W1 GROUND TIME OC RESET](#) setpoint is obtained using the setup in FIGURE 7-9: *General test setup* on page 7-25. The procedure consists of repetitive operating time measurements in quick succession. If the reset is selected for “Instantaneous”, the operating time always equals the nominal time derived from the selected curve. If the reset is selected as “Linear”, the operating time varies as a function of the time between successive applications of the current signal. If this test is performed at current multiples of 2 to 3 times the pickup level, the variations in operating time are easier to detect.

7.5.10.6 Winding 2 or 3 elements

Because the second ground time overcurrent element could be set with completely different parameters than the element for the first winding, it is necessary to repeat the full set of tests described above for each winding.

To test the second element,

- ▷ Disable all protection elements except for the [W2 GROUND TIME OVERCURRENT](#) (or [W3 GROUND TIME OVERCURRENT](#)) element.
- ▷ Connect the current signal to X = F12 and Y = E12.
- ▷ Repeat all the tests described for the winding 1 ground time overcurrent element in this section.



The blocking from logic input, if enabled, can be tested as described in earlier tests for other elements.

7.5.11 Ground Instantaneous Overcurrent 1

7.5.11.1 Description

This procedure verifies that the ground instantaneous overcurrent performance matches the in-service settings. Settings for these elements are found under the **S4 ELEMENTS ▾ ▾ GROUND OC ▾ ▾ W1 GND INST OC 1** setpoints menu. If your relay settings require you to test at current multiples of several times the rated CT secondary value do not leave the current signal on for more than a few seconds.

7.5.11.2 Winding 1 Element

To ensure only the ground instantaneous overcurrent 1 element operates the trip relays (and any other output relays) selected by the logic, disable all protection features except ground instantaneous overcurrent 1. Use the test setup shown in FIGURE 7-9: *General test setup* on page 7-25.

Connect the current supply to terminals X = H10 and Y = G10 to test the winding 1 element. Monitor the appropriate output relays as per the relay FlexLogic™ settings or assigned relay settings.

7.5.11.3 Pickup Level

- ▷ With the interval timer disabled, apply the current signal and increase its magnitude until the trip relay (and all the selected auxiliary relays) operate.
- ▷ Compare the measured operating level against the **S4 ELEMENTS ▾ ▾ GROUND OC ▾ ▾ W1 GND INST OC 1 ▾ ▾ W1 GND INST OC 1 PICKUP** setpoint.
- ▷ When the element operates, check that the Trip and Message LEDs are flashing and one of the following messages is displayed:
 - LATCHED a: W1 Gnd Inst OC 1** or **OPERATED a: W1 Gnd Inst OC 1**
- ▷ Reduce the current until the element resets.
The reset level should be 97% of the operate level. When the element resets the Trip, Ground, and Message LEDs should remain on if the **W1 GND INST OC 1 TARGET** was selected as “Latched”. Otherwise, only the Trip LED should stay on.
- ▷ Reset indicators and clear messages.

7.5.11.4 Operating Time

Using the setup shown in FIGURE 7-9: *General test setup* on page 7-25 with the Interval Timer enabled,

- ▷ Set the current level to 1.5 times the element operate level and apply suddenly by closing the double-pole switch.
- ▷ Record the operate time and compare to the **S4 ELEMENTS ▾ ▾ GROUND OC ▾ ▾ W1 GND INST OC 1 ▾ ▾ W1 GND INST OC 1 DELAY** value.

7.5.11.5 Winding 2 or 3 Element

Because the winding 2 and 3 elements can be set with completely different parameters than the winding 1 elements, it is necessary to repeat the full set of tests described in this section for each winding.



Only two ground instantaneous overcurrent 1 elements can be in service simultaneously.



The blocking from logic input, if enabled, can be tested as described in earlier tests for other elements.

7.5.12 Ground Instantaneous Overcurrent 2

The ground instantaneous overcurrent 2 elements are identical to the ground instantaneous overcurrent 1 elements. Consequently, the same test procedure may be used to verify their correct operation. Disable all protection features except ground instantaneous overcurrent 2. Make the appropriate changes for the display indications and output relays operated by the ground instantaneous overcurrent 2 elements.

7.5.13 Restricted Ground Fault Polarity Test

This procedure verifies the correct wiring of field CTs (phase and ground) to the corresponding phase and ground CT terminals on the relay for the purposes of the restricted ground fault protection. The correct wiring is determined by the distribution of fault current during external phase A to ground faults on wye-connected windings with grounded neutral.

From the figure below, the I_f fault current travels through the wye-grounded neutral as I_g and can be simulated by injecting a single current into the phase A (W2) and G1/2 terminals.

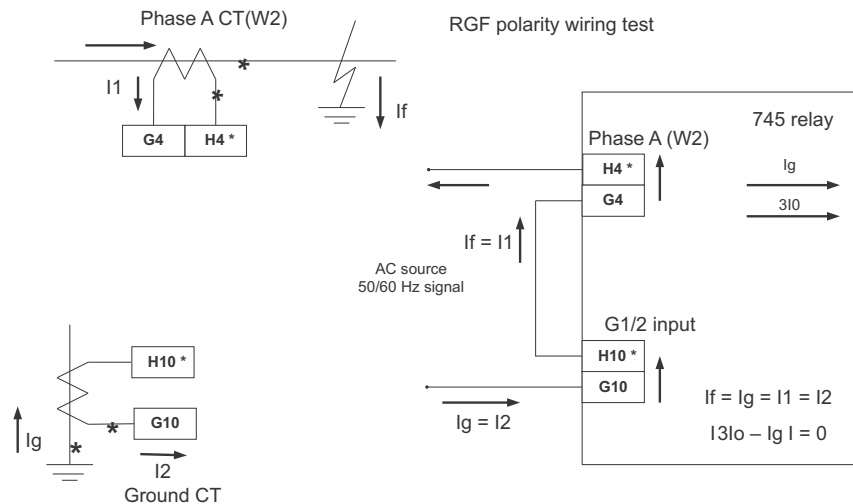

FIGURE 7-10: Fault current distribution due to an external phase-to-ground fault on winding 2

The procedure for this test is shown below:

- ▷ Select the D/Y30° transformer type into the relay and set the same CT ratio for both phase and ground winding inputs.
The selected transformer type assures the G1/2 ground input is associated to winding 2 (wye).
- ▷ Enable the restricted ground fault protection only and monitor the ground differential current under the relay actual values.
- ▷ Connect the single current source to inject current into G10 of the ground G1/2 terminal and to the connected in-series winding 2 phase A terminals as shown on the figure above.
- ▷ Verify the ground current and phase A current are in phase
- ▷ Verify the ground differential current is zero



NOTE

The polarities and wirings of the CTs for the restricted ground fault protection are correct if the external phase-to-ground fault current is seen on both relay terminals (phase and ground) in the same direction. The response of the restricted ground fault protection is based on the magnitude of the ground differential current resulting from the vector difference of the neutral and ground currents; that is, $I_{gd} = |3I_0 - I_g|$.

7.5.14 Restricted Ground Fault Element Test

7.5.14.1 Description

This procedure verifies that the restricted ground fault performance matches the in-service settings. The ground element measures the current signal connected to the ground current input CT, H10 and G10 or F12 and E12. The neutral ($3I_0$) current is calculated from the vector sum of the three phase currents. Injecting current into one phase automatically produces a neutral current (i.e. $3I_0 = I_A$). Settings for these elements are found in the [S4 ELEMENTS ▷ ▾ RESTRICTED GROUND ▷ ▾ W1\(3\) RESTD GND FAULT](#) setpoints menu.

7.5.14.2 Winding 1 Element

To ensure that only the restricted ground fault element operates the trip relays (and any other output relays selected by the logic) disable all protection features except restricted ground fault.

Using a current supply as shown in the figure below, connect the I_1 current source to terminals H1 and G1 for the winding 1 phase current element and I_2 to terminals G10 and H10 as shown for the ground current element. Monitor the appropriate output relays as per the relay FlexLogic™ settings or assigned relay settings.

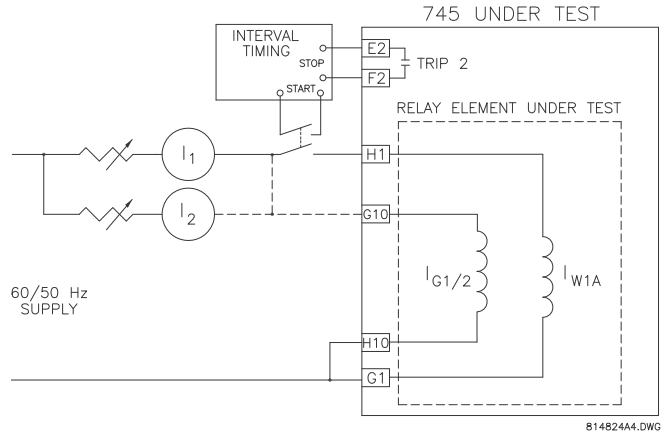

FIGURE 7-11: Restricted ground test setup

7.5.14.3 Pickup Level

- ▷ With the interval timer disabled, apply the current signal feeding the phase current element and increase its magnitude slowly until the trip relay, and all the selected auxiliary relays, operate. The operate level should correspond to the [S4 ELEMENTS ▷▽ RESTRICTED GROUND ▷ W1 RESTD GND FAULT ▷▽ W1 RESTD GND FAULT PICKUP](#) setting.
- ▷ When the element operates, check that the Trip, Ground, and Pickup LEDs are on and that one of the following messages is displayed:
LATCHED a: W1 Restd Gnd Fault or **OPERATED a: W1 Restd Gnd Fault**
- ▷ Reduce the current until the element resets. The reset level should be 97% of the operate level. When the element resets, the Trip and Message LEDs should remain on if the [W1 RESTD GND FAULT TARGET](#) was selected as **Latched**. Otherwise, only the Trip LED should remain on.
- ▷ Reset indicators and clear messages.

7.5.14.4 Operating Time

- ▷ Select three (3) or four (4) delay times at which the timing is to be measured.
- ▷ With the interval timer enabled, set the current level to the desired value and apply suddenly by closing the double-pole switch.
- ▷ Record the operate time and compare to the expected value.
- ▷ Repeat for the all the desired values of current.

7.5.14.5 Slope

- ▷ To measure the slope, connect current signals to the relay as shown in the figure above.

- ▷ Inject the I_1 current such that the ground differential pickup value divided by the I_1 current is less than the slope setting. Set $I_2 = 0$ A. The element will operate since the current appears as ground differential.
- ▷ The slope is calculated from the values of $I_{ground\ differential}$ and I_{max} as shown below:

$$\%slope = \frac{I_{ground\ differential}}{I_{max}} \times 100\% \quad (\text{EQ 7.11})$$

where I_{max} represents the maximum phase current for the winding being measured.

As I_2 is increased, the element will reset when the percentage of slope drops below the slope setting.

- ▷ Slowly increase I_2 until the element operates again.
- ▷ Calculate the slope at this point.
- ▷ Decrease the slope setting to 0% then continue to increase the I_2 current until the element resets.
- ▷ Slowly increase I_2 until the element operates again.

The reset level should be 97% of operate level. When the element resets, the Trip and Message LEDs should remain on if the **W1 RESTD GND FAULT TARGET** was selected as "Latched". Otherwise only the Trip LED should remain on.

7.5.14.6 Winding 2 or 3 Elements

Since the second restricted ground fault element can be set with completely different parameters than the first element winding, it is necessary to repeat the full set of tests described in this section for each winding.

To test the second element,

- ▷ Disable all protection elements except for the winding 2 (or winding 3 as appropriate) restricted ground fault element.
- ▷ Connect the ground current signal to terminals F12 and E12.
- ▷ Repeat all the tests described for the winding 1 element in this section.



The blocking from logic input, if enabled, can be tested as described in earlier tests for other elements.

7.5.15 Negative-sequence Time Overcurrent

7.5.15.1 Description

This procedure verifies that the negative-sequence time overcurrent performance matches the in-service settings. Since these elements can have any one of a multitude of timing curves, a table of expected operating times versus applied current should be prepared prior to testing the elements. The negative-sequence element measures the derived negative-sequence component of the phase current signals connected to the

phase input CTs. Refer to *Time Overcurrent Curves* on page 5–58 for additional information on timing curves.

If the relay elements are set for “Linear” reset characteristic when measuring the operating times, ensure that there is sufficient time between test current injections for the element to reset fully. Otherwise, erroneous timing measurements will be obtained. Settings for these elements are found in the [S4 ELEMENTS ▾ ▽ NEG SEQ OC ▾ ▽ W1 NEG SEQ TIME OC](#) settings menu.

7.5.15.2 Winding 1 Element

To ensure that only the negative-sequence time overcurrent element operates the trip relays (and any other output relays selected by the logic),

- ▷ Disable all protection features except negative-sequence time overcurrent.
- ▷ Use the general test setup shown in [FIGURE 7–9: General test setup](#) on page 7–25.
- ▷ Connect the current supply to terminals X = H1 and Y = G1 to test the winding 1 negative-sequence element.
- ▷ Monitor the appropriate output relays as per the relay FlexLogic™ settings or assigned relay settings.

7.5.15.3 Pickup Level

- ▷ With the interval timer disabled, apply the current signal and slowly increase its magnitude until the trip relay and all selected auxiliary relays operate.
If the relay has a very inverse time characteristic, it is easier and more accurate to increase the current far above the pickup level until the trip relay operates then reduce the current to just above the operate level.
- ▷ Slowly reduce the current below the operate level and observe for a reset action on the trip relay.
This reset level for the current should be approximately 98% of the pickup level.
- ▷ Once the relay drops out, *slowly* increase the current until the trip contact closes. The operate level should correspond to the [S4 ELEMENTS ▾ ▽ NEG SEQ OC ▾ ▽ W1 NEG SEQ TIME OC ▾ ▽ W1 NEG SEQ TIME OC PICKUP](#) setting.



With current applied to a single phase, the negative sequence current component is calculated from:

$$I_{neg\ seq} = \frac{1}{3} \times I_{phase} \tag{EQ 7.12}$$

Hence, the phase current will be three times the pickup setting.

- ▷ Check that, when the element operates, the Trip and Pickup LEDs are on, and one of the following messages is displayed:

LATCHED a: W1 Neg Seq Time OC or OPERATED a: W1 Neg Seq Time OC

- ▷ Reduce the current until the element resets.
The reset level should be 97% of the operate level. When the element resets the Trip and Message LEDs should remain on if the **W1 NEG SEQ TIME OC TARGET** was selected as **Latched**. Otherwise only the Trip LED remains on.
- ▷ Reset indicators and clear messages.

7.5.15.4 Operating Time

- ▷ Using a table like the one shown below, select 3 or 4 values of current multiples at which the timing is to be measured.
- ▷ Enter the expected operating times from the timing curve applied in the settings.
- ▷ Using the setup in FIGURE 7–9: *General test setup* on page 7–25 with the interval timer enabled, set the current level to the desired value (taking into account the relationship mentioned above) and apply suddenly by closing the double-pole switch.
- ▷ Record the operate time and compare to the expected value.
- ▷ Repeat for all desired values of current.

Current multiple	Nominal time	Measured time
1.5		
3		
5		

7.5.15.5 Reset time

A simple verification of which reset mode, selected with the **S4 ELEMENTS ▷ ▽ NEG SEQ OC ▷ W1 NEG SEQ TIME OC ▷ ▽ W1 NEG SEQ TIME OC RESET** setpoint, can be obtained using the simple test setup in FIGURE 7–9: *General test setup* on page 7–25. The procedure consists of repetitive operating time measurements in quick succession. If the reset is selected for “Instantaneous”, the operating time is always equal to the nominal time derived from the selected curve. If the reset is selected as **Linear**, the operating time varies as a function of the time between successive applications of the current signal. If this test is performed at current multiples of 2 to 3 times the pickup level, the variations in operating time are easier to detect.

7.5.15.6 Winding 2 and 3 Elements

Because the negative-sequence time overcurrent elements on windings 2 and/or 3 can be set with completely different parameters than those for the first element, it is necessary to repeat the full set of tests described in this section for each winding.

To test these elements, disable all protection elements except for winding 2 negative-sequence time overcurrent. Connect the current signal to X = H4 and Y = G4. Repeat all the tests described for the winding 1 element in this section. For winding 3, connect the current signal to X = H7 and Y = G7.



The blocking from logic input, if enabled, can be tested as described in earlier tests for other elements.

7.5.16 Negative-sequence Instantaneous Overcurrent

7.5.16.1 Description

This procedure verifies that the negative-sequence instantaneous overcurrent performance matches the in-service settings. These elements are found under the **S4 ELEMENTS > NEG SEQ OC > W1 NEG SEQ INST OC** settings menu. If the relay settings require testing at current multiples of several times the rated CT secondary value, *do not leave the current signal on for more than a few seconds.*

7.5.16.2 Winding 1 element

To ensure that only the Negative Sequence Instantaneous Overcurrent element operates the trip relays (and any other output relays selected by the logic),

- ▷ Disable all protection features except Negative Sequence Instantaneous Overcurrent.
- ▷ Use the general test setup in FIGURE 7-9: *General test setup* on page 7-25.
- ▷ Connect the current supply to terminals X = H1 and Y = G1 to test the Winding 1 element.
- ▷ Monitor the appropriate output relays as per the relay FlexLogic™ settings.

7.5.16.3 Pickup Level

- ▷ With the interval timer disabled, apply the current signal and increase its magnitude until the trip relay and all selected auxiliary relays operate.
- ▷ Compare the measured operating level against the **S4 ELEMENTS > NEG SEQ OC > W1 NEG SEQ INST OC > W1 NEG SEQ INST OC PICKUP** relay settings.



With current applied to a single phase, the negative sequence current component is calculated from:

$$I_{neg\ seq} = \frac{1}{3} \times I_{phase} \tag{EQ 7.13}$$

Hence, the phase current will be three times the pickup setting.

- ▷ When the element operates, check that the Trip and Pickup LEDs are on and one of the following is displayed:

LATCHED a: W1 Neg Seq Inst OC or **OPERATED a: W1 Neg Seq Inst OC**

- ▷ Reduce the current until the element resets.
The reset level should be 97% of the operate level. When the element resets, the Trip and Message LEDs should remain on if the **W1 NEG SEQ INST OC TARGET** was selected as **Latched**. Otherwise, only the Trip LED should remain on.
- ▷ Reset indicators and clear messages.

7.5.16.4 Operating Time

- ▷ Using the setup in *General test setup* on page 7–25 with the Interval Timer enabled, set the current level to 1.5 times the operate level of the element and apply suddenly by closing the double-pole switch.
- ▷ Record the operate time and compare to the **S4 ELEMENTS ▷ ▾ NEG SEQ OC ▷ ▾ W1 NEG SEQ INST OC ▷ ▾ W1 NEG SEQ INST OC DELAY** setting.

7.5.16.5 Winding 2 and 3 Elements

Because the winding 2 and 3 elements can be set with completely different parameters than the element for winding 1,

- ▷ Repeat the full set of tests described for the winding 1 element in this section.
- ▷ Connect the current supply to terminals X = H4 and Y = G4 to test the Winding 2 element. Use X = H7 and Y = G7 for the Winding 3 element.



NOTE

The blocking from logic input, if enabled, can be tested as described in earlier tests for other elements.

7.5.17 Frequency

7.5.17.1 Setup

The power system frequency is measured from the voltage input if it has been enabled. If there is no voltage input, it is measured from the winding 1 phase A current signal. These tests require a variable-frequency current source for relays without a voltage input and a variable-frequency voltage and current source for relays with a voltage input. Connections are shown in the figure below. Only perform tests specific to the relay model.



NOTE

The underfrequency, overfrequency, and frequency decay elements are all supervised by optional adjustable minimum current and minimum voltage level detectors. When testing the performance of these elements on a 745 with the voltage input enabled, it may be necessary to inject a current signal into winding 1 phase A if the current supervision is enabled, or else the detectors will not operate.

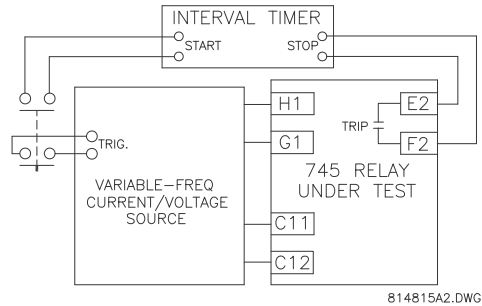

FIGURE 7-12: Frequency element testing

7.5.17.2 Underfrequency 1

As a preliminary step, disable all protection functions except underfrequency 1. Verify that settings match the in-service requirements. Settings are entered or modified in the **S4 ELEMENTS > ▾ FREQUENCY > UNDERFREQUENCY 1** settings menu.

Voltage input function (voltage input enabled):

- ▷ Using the variable-frequency voltage/current source connected to terminals C11 and C12 for the voltage signal and H1 and G1 for the current signal, set the frequency to 60.00 Hz (or 50.00 Hz for 50 Hz systems) and the voltage amplitude to the rated VT secondary voltage.
- ▷ Set the current amplitude to rated CT secondary.
- ▷ Monitor the appropriate trip and auxiliary relays.
- ▷ Reset all alarms and indications on the relay.
The relay display should remain with no trip indications.
- ▷ Slowly decrease the frequency until the output relay(s) operate.
- ▷ Check that the operation took place at the selected frequency setting.
- ▷ As the frequency is varies, verify that the correct system frequency is displayed by the **A2 METERING > ▾ FREQUENCY > SYSTEM FREQUENCY** actual value.
- ▷ Slowly reduce the voltage and note the voltage at which the output relay(s) reset.
- ▷ Check that this dropout voltage is approximately the voltage supervision value in the **S4 ELEMENTS > ▾ FREQUENCY > UNDERFREQUENCY 1 > ▾ MINIMUM OPERATING VOLTAGE** setpoint.



If voltage supervision is set to 0.0, then the element remains operated until the voltage is decreased below approximately 2%, the level at which measurements become unreliable.

- ▷ Slowly increase the voltage and check that the element operates when the voltage reaches 2% above the supervision level.
- ▷ Return the voltage to nominal value.
- ▷ Slowly decrease the current until the element resets.

- ▷ Check that this dropout current level is equal to the **S4 ELEMENTS ▷ FREQUENCY ▷ UNDERFREQUENCY 1 ▷ MINIMUM OPERATING CURRENT** setting:



If current sensing is disabled in the element, it will remain operated with current reduced to 0.0 A.

- ▷ Slowly increase the current and ensure the element operates when the current reaches a value just above the setting. Set the current to rated CT secondary.
- ▷ Check that the Trip and Pickup LEDs are on and one of the following trip messages is displayed:

LATCHED: Underfrequency 1 or **OPERATED: Underfrequency 1**

- ▷ Slowly increase the frequency until the Pickup LED and output relays reset. Note the dropout level, which should be the pickup plus 0.03 Hz.
- ▷ Check that the Trip LED is still on.
The trip message will stay on if the **UNDERFREQUENCY 1 TARGET** setting is “Latched”; if set to “Self-resetting”, the message will reset when frequency is above the setpoint.

For timing tests, the signal generator must be capable of triggering into step-wise changing of frequency or ramping down to a pre-selected frequency in only a few milliseconds.

- ▷ Connect the Signal Source and Timer Start triggers as shown in FIGURE 7–12: *Frequency element testing* on page 7–44.
- ▷ Set the voltage to rated VT secondary value, the current to rated CT secondary, and the pre-trigger frequency to the nominal frequency (60 or 50 Hz).
If current sensing is not enabled, it is not necessary to connect the current signal.
- ▷ Set the post-trigger to 0.5 Hz below the setting for underfrequency 1. Reset all targets and relays, if necessary.
- ▷ Reset the timer.
- ▷ Initiate the frequency step and timer start.
The Interval Timer will record the operating time of element. Compare this time to the **S4 ELEMENTS ▷ FREQUENCY ▷ UNDERFREQUENCY 1 ▷ UNDERFREQUENCY 1 DELAY** setpoint value:

Provided that the operate times are not scattered over a wide range, it may be desirable to repeat this test several times and average the results. If there is a wide scatter, verify the test setup and ensure the signal source behaves in a consistent manner.

Current input function (voltage input disabled):

- ▷ If the frequency elements are using the winding 1 phase A current signal as a source, verify the operation of the element using the instructions below.

- ▷ Using the variable-frequency current source connected to terminals H1 and G1 with no voltage connections, set the frequency to 60.00 Hz (or 50.00 Hz) and the amplitude to the rated CT secondary current.
- ▷ Monitor the appropriate trip and auxiliary relays.
- ▷ Reset all alarms and indications.
The display should remain unchanged with no trip indications.
- ▷ Slowly decrease the frequency until the output relay(s) operate.
Check that the frequency at which operation took place is the selected frequency setting.
- ▷ Slowly reduce the current.
- ▷ Note the current at which the output relay(s) reset.
- ▷ Check that this dropout current is the minimum operating current selected in the settings.



If current sensing is not enabled, then the element will continue working all the way down to a current level of $0.02 \times CT A$.

- ▷ Increase the current back to nominal. Verify that the relay(s) operate.
- ▷ Check that the Trip and Pickup LEDs are on and one of the following trip messages is displayed:
LATCHED: Underfrequency 1 or **OPERATED: Underfrequency 1**
- ▷ Slowly increase the frequency until the Pickup LED and output relays reset.
- ▷ Note the dropout level, which should be the pickup plus 0.03 Hz.
- ▷ Check that the Trip LED is still on.
The trip message remains on if the **UNDERFREQUENCY 1 TARGET** setting is **Latched**; if set to “Self-Resetting”, the message resets when frequency is above the setpoint.

For timing tests, the signal generator must be capable of triggering into step-wise changing of frequency or ramping down to a pre-selected frequency in only a few milliseconds.

- ▷ Connect the signal source and timer start triggers as shown in FIGURE 7-12: *Frequency element testing* on page 7-44.
- ▷ Set the current to rated CT secondary value, no voltage connection, and the pre-trigger frequency to the nominal frequency (60 or 50 Hz).
- ▷ Set the post-trigger to 0.5 Hz below the underfrequency 1 setting.
If necessary, reset all targets and relays.
- ▷ Reset the timer.
- ▷ Initiate the frequency step and timer start.
The Interval Timer will record the operating time of element.
- ▷ Compare this time to the **S4 ELEMENTS ▷▽ FREQUENCY ▷ UNDERFREQUENCY 1 ▷▽ UNDERFREQUENCY 1 DELAY** setting.

- ▷ Provided that the operate times are not scattered over a wide range, it may be desirable to repeat this test several times and average the results.
- ▷ If there is a wide scatter, verify the test setup and ensure the signal source behaves in a consistent manner.



NOTE

The blocking from logic input, if enabled, can be tested as described in earlier tests for other elements.

7.5.17.3 Underfrequency 2

- ▷ Disable all protection functions except the underfrequency 2 function.
- ▷ Verify that settings match in-service requirements. Enter/modify settings and logic in the [S4 ELEMENTS ▷ ▾ FREQUENCY ▷ ▾ UNDERFREQUENCY 2](#) setpoints menu.
- ▷ Repeat the appropriate steps of *Underfrequency 1* on page 7–44 for this element.
- ▷ Compare the results to the settings for the underfrequency 2 element.

7.5.17.4 Overfrequency

- ▷ Disable all protection functions except overfrequency.
- ▷ Verify that settings match in-service requirements. Overfrequency settings are modified in the [S4 ELEMENTS ▷ ▾ FREQUENCY ▷ ▾ OVERFREQUENCY](#) settings menu.

Voltage input function (voltage input enabled):

Using the variable-frequency voltage/current source connected to terminals C11 and C12 for the voltage signal and H1 and G1 for the current signal,

- ▷ Set the frequency to 60.00 Hz (or 50.00 Hz) and the voltage amplitude to the rated VT secondary voltage.
- ▷ Set the current amplitude to rated CT secondary.
- ▷ Monitor the appropriate trip and auxiliary relays.
- ▷ Reset all alarms and indications on the relay. The 745 display should remain unchanged with no trip indications.
- ▷ Slowly increase the frequency until the output relay(s) operate.
- ▷ Check that the frequency at which operation took place is the selected frequency setting.
- ▷ As the frequency is varied, verify that the [A2 METERING ▷ ▾ FREQUENCY ▷ SYSTEM FREQUENCY](#) actual value indicates the correct value of system frequency.
- ▷ Slowly reduce the voltage.
- ▷ Note the voltage at which the output relay(s) reset.

- ▷ Check that this dropout voltage is equal to the **S4 ELEMENTS ▷▷ FREQUENCY ▷▷ OVERFREQUENCY ▷▷ MINIMUM OPERATING VOLTAGE** voltage level.
Note that this level can be set down to 0.00 A, in which case the element remains operated to a voltage level of approximately 2% of nominal.
- ▷ Slowly increase the voltage and check that the element operates when the voltage reaches 2% above the set level.
- ▷ Return the voltage to nominal value.
- ▷ Slowly decrease the current until the element resets.
- ▷ Check that this dropout current level is equal to the **S4 ELEMENTS ▷▷ FREQUENCY ▷▷ OVERFREQUENCY ▷▷ MINIMUM OPERATING CURRENT** setting.
If current sensing has not been enabled for this element, the element remains operated for current levels down to 0.00 A.
- ▷ Slowly increase the current and check that the element operates when the current reaches a value just above the setting.
- ▷ Set the current to rated CT secondary.
- ▷ Check that the Trip and Pickup LEDs are on and one of the following trip messages is displayed:
LATCHED: Overfrequency or **OPERATED: Overfrequency**
- ▷ Slowly decrease the frequency until the Pickup LED and output relays reset.
- ▷ Note the dropout level, which should be the pickup minus 0.03 Hz.
Check that the Trip LED is still on.
The trip message remains on if the **OVERFREQUENCY TARGET** setting is “Latched”; if set to “Self-resetting”, the message resets when frequency is below the setpoint.

For timing tests, the signal generator must be capable of triggering into step-wise changing of frequency or ramping down to a pre-selected frequency in only a few milliseconds.

- ▷ Connect the signal source and timer start triggers as shown in FIGURE 7-12: *Frequency element testing* on page 7-44.
- ▷ Set the voltage to rated VT secondary value, the current to rated CT secondary, and the pre-trigger frequency to nominal frequency (60 or 50 Hz).
The current signal is not required if current sensing is not enabled for this element.
- ▷ Set the post-trigger to 0.5 Hz above the setting of the overfrequency element. If necessary, reset all targets and relays.
- ▷ Reset the timer.
- ▷ Initiate the frequency step and timer start.
The interval timer records the operating time of element.

- ▷ Compare this time to the **S4 ELEMENTS ▷ FREQUENCY ▷ OVERFREQUENCY DELAY** setting.

Provided that the operate times are not scattered over a wide range, it may be desirable to repeat this test several times and average the results.

If there is a wide scatter, verify the test setup and ensure the signal source behaves in a consistent manner.

Current input function (voltage input disabled):

If the voltage input is disabled, the frequency elements use the winding 1 phase A current signal as a source. Verify the operation of the element using the procedure below.

- ▷ Using the variable-frequency current source connected to terminals H1 and G1, no voltage connections, frequency at 60.00 Hz (or 50.00 Hz), and the amplitude to rated CT secondary current.
- ▷ Monitor the appropriate trip and auxiliary relays.
- ▷ Reset all relay alarms and indications.
The relay display should remain unchanged with no trip indications.
- ▷ Slowly increase the frequency until the output relay(s) operate.
- ▷ Check that the frequency at which operation took place is the selected frequency setting.
- ▷ Slowly reduce the current.
- ▷ Note the current at which the output relay(s) reset.
- ▷ Check that this dropout current is the minimum operating current selected in the settings.
If current sensing has been disabled for this element, then operation continues down to 0.00 A.
- ▷ Increase the current back to nominal.
- ▷ Check that the relay(s) operate.
- ▷ Check that the Trip and Pickup LEDs are on and one of the following trip messages is displayed:
LATCHED: Overfrequency or **OPERATED: Overfrequency**
- ▷ Slowly decrease the frequency until the Pickup LED turns on and output relays reset.
- ▷ Note the dropout level, which should be the pickup minus 0.03 Hz.
- ▷ Check that the Trip LED is still on.
The trip message stays on if the **OVERFREQUENCY TARGET** setting is **Latched**; if it is **Self-resetting**, the message resets when frequency is below the setpoint.
- ▷ For timing tests, the signal generator must be capable of triggering into step-wise changing of frequency or ramping down to a pre-selected frequency in only a few milliseconds.
- ▷ Connect the signal source and timer start triggers as shown in FIGURE 7-12: *Frequency element testing* on page 7-44.

- ▷ Set the current to rated CT secondary value, no voltage connection, and the pre-trigger frequency to the nominal frequency (60 or 50 Hz).
- ▷ Set the post-trigger to 0.5 Hz above the setting of the Overfrequency element.
- ▷ Reset all targets and relays, if necessary.
- ▷ Reset the timer.
- ▷ Initiate the frequency step and timer start.
The Interval Timer records the element operating time.
- ▷ Compare this time to the [S4 ELEMENTS ▷ ▾ FREQUENCY ▷ ▾ OVERFREQUENCY ▷ ▾ OVERFREQUENCY DELAY](#) setting:

Provided that the operate times are not scattered over a wide range, it may be desirable to repeat this test several times and average the results.

If there is a wide scatter, verify the test setup and ensure the signal source behaves in a consistent manner.



The blocking from logic input, if enabled, can be tested as described in earlier tests for other elements.

7.5.17.5 Frequency Decay Rate



A high-quality programmable function generator is required to verify this element. Since the frequency rates of change are measured over a narrow range, the test instrumentation must accurately simulate frequency decay rates without any significant jitter. It is the experience of GE Multilin that some commercial dedicated relay test equipment with built-in frequency ramping functions is not accurate enough to verify the 745 performance.

- ▷ Disable all protection functions except the Frequency Decay function.
- ▷ Verify that settings match in-service requirements.
The settings are entered and modified in the [S4 ELEMENTS ▷ ▾ FREQUENCY ▷ ▾ FREQUENCY DECAY](#) setpoints menu.

The following procedures are for the frequency decay rate 1 element. They can be applied to the frequency decay rate 2, 3, and 4 elements as well, making the necessary changes where appropriate.

Voltage input function (voltage input enabled):

- ▷ Use a frequency-ramping programmable voltage/current source connected to terminals C11 and C12 for the voltage signal and H1 and G1 for the current signal.
- ▷ Set the frequency to 60.00 Hz (or 50.00 Hz) and the voltage amplitude to the rated VT secondary voltage.
- ▷ Set the current amplitude to rated CT secondary (*Note: if current sensing is disabled for this element, the current signal is not required for the tests*).
- ▷ Monitor the appropriate trip and auxiliary relays.

- ▷ Reset all alarms and indications on the relay.
The relay display should remain unchanged with no trip indications.
- ▷ Program the function generator to simulate a frequency rate-of-change just above rate 1.
The start frequency should be the nominal frequency of the relay; the end frequency must be below the frequency decay threshold if the relay is to operate. Note that operation occurs if the rate criterion is satisfied and the frequency is below the threshold.
- ▷ Initiate ramping action and verify element operation once the frequency drops below the threshold.
- ▷ Check that the Trip and Pickup LEDs are on and one of the following trip messages is displayed:
LATCHED: Freq Decay Rate 1 or **OPERATED: Freq Decay Rate 1**
If the target was selected as **Latched**, the Trip LED and the message remain on.
- ▷ Reduce the voltage to below the **S4 ELEMENTS ▷▽ FREQUENCY ▷▽ FREQUENCY DECAY ▷▽ MINIMUM OPERATING VOLTAGE** voltage supervision level.
- ▷ Repeat ramping action and verify that element does not operate.
If the voltage supervision level has been set to 0.00, the element continues to operate correctly down to approximately 2% or nominal.
- ▷ Return voltage to nominal value.
- ▷ If current sensing is enabled, set the current level below the **S4 ELEMENTS ▷▽ FREQUENCY ▷▽ FREQUENCY DECAY ▷▽ MINIMUM OPERATING CURRENT** value.
- ▷ Repeat ramping action and verify that element does not operate.
- ▷ For timing tests, an approximate operate time is obtained if a timer is triggered at the same time as the ramping action and the time interval between the trigger point and the relay operation measured.
From that measured time, subtract the time required for the frequency to reach the threshold value.

Current input function (voltage input disabled):

- ▷ Using a frequency-ramping programmable voltage/current source connected to terminals H1 and G1 for the current signal, set the frequency to 60.00 Hz (or 50Hz). Set the current amplitude to rated CT secondary.
- ▷ Monitor the appropriate trip and auxiliary relays.
- ▷ Reset all alarms and indications on the relay.
The relay display should remain unchanged with no trip indications.
- ▷ Program the function generator to simulate a frequency rate-of-change just above rate 1.
The start frequency should be the nominal frequency of the relay. The end frequency must be below the frequency decay threshold if the relay

is to operate.

Note that operation occurs if the rate criterion is satisfied and the frequency is below the threshold.

- ▷ Initiate ramping action and verify that the element operates once the frequency drops below the threshold.
- ▷ Check that the Trip and Pickup LEDs are on and one of the following trip messages is displayed:
 - LATCHED: Freq Decay Rate 1** or **OPERATED: Freq Decay Rate 1**

If the target was selected as **Latched**, the Trip LED and the message remain on.
- ▷ Set the current level to a value below the [S4 ELEMENTS ▷ FREQUENCY ▷ FREQUENCY DECAY ▷ MINIMUM OPERATING CURRENT](#) value.
- ▷ Repeat ramping action and verify that element does not operate.

If current sensing has been disabled for this element, operation will continue down to a current level of approximately 2% of nominal.
- ▷ For timing tests, an approximate operate time is obtained if a timer is triggered at the same time as the ramping action and the time interval between the trigger point and the relay operation measured.
- ▷ From that measured time, subtract the time required for the frequency to reach the threshold value.

The expected time must be computed using the rate of change and the effect of the [S4 ELEMENTS ▷ FREQUENCY ▷ FREQUENCY DECAY ▷ FREQUENCY DECAY DELAY](#) time delay.

7.5.18 Overexcitation

7.5.18.1 Volts per Hertz

The following procedure applies to both volts-per-hertz elements; make the necessary changes where appropriate. The volts-per-hertz operating levels are set in terms of the relay-input voltage divided by the frequency of that voltage.

- ▷ Disable all elements except volts-per-hertz 1.
- ▷ Monitor the appropriate contact.
- ▷ Use the test setup in [FIGURE 7–12: Frequency element testing](#) on page 7–44 with variable-frequency voltage source.

The Volts-per-hertz settings are found in the [S4 ELEMENTS ▷ OVEREXCITATION ▷ VOLTS-PER-HERTZ 1](#) setpoints menu.

- ▷ Apply a voltage starting at 60 Hz and increase the magnitude until the element operates.
- ▷ Reduce the frequency in steps of 5 Hz and repeat the measurement.

The element should operate at a consistent value of volts/hertz equal to the setting of the element.
- ▷ Check that the Trip and Pickup LEDs are on and one of the following trip messages is displayed:

LATCHED: Volts-Per-Hertz 1 or **OPERATED: Volts-Per-Hertz 1**

- ▷ For timing tests, prepare a table of expected operating time versus applied V/Hz signal from the selected timing curve for the element.
- ▷ Using the variable frequency function generator to simulate the different V/Hz ratios, apply suddenly to the relay and measure the operating time.

7.5.18.2 Fifth Harmonic Scheme

The 5th harmonic scheme operates if the 5th harmonic content of any current signal connected to the relay exceeds the threshold setting, for the set time, provided that the level is above the set threshold.

- ▷ Disable all protection functions except the 5th harmonic function. The 5th harmonic scheme settings are in the [S4 ELEMENTS ▷▽ OVEREXCITATION ▷▽ 5th HARMONIC LEVEL](#) setpoints menu.

This test requires a current generator capable of producing a fundamental and 5th harmonic component.

- ▷ Connect the current signal to H1 and G1 and set the fundamental component level above the threshold setting.
- ▷ Slowly increase the amplitude of the 5th harmonic component until the element operates.
- ▷ Calculate the ratio of 5th harmonic to fundamental at which operation occurred and compare this value to the setting of the element.
- ▷ Check that the Trip, Pickup (and if selected, Alarm) LEDs are on, and one of the following is displayed:

LATCHED: 5th Harmonic Level or **OPERATED: 5th Harmonic Level**

- ▷ Reduce the 5th harmonic component until the element resets. The reset level should be 97% of the operate level.
- ▷ Reset indicators and clear messages.
- ▷ Repeat the above steps with a fundamental current level below the threshold setting.
- ▷ Ensure that the element does not operate.
- ▷ For timing tests, simulate an operating condition as above and apply suddenly to the relay and measure the operating time. The time should be the same as the setting in the element.

7.5.19 Insulation Aging

7.5.19.1 Description

The three elements under the insulation aging feature, *hottest-spot limit*, *aging factor limit*, and *loss of life limit*, must be tested with a valid set of transformer data programmed into the relay. The ambient temperature must also be programmed (obtained from an RTD or programmed as 12-month averages). The tests consist of simulating transformer loading by applying a current signal to winding 1 phase A at the correct frequency.

7.5.19.2 Hottest-spot Limit

The hottest-spot temperature value is a function of load, ambient temperature, and transformer rating.

- ▷ Apply a current to winding 1 phase A to represent at least a 100% load on the transformer.
- ▷ Use the [A2 METERING ▷ ▾ LOSS OF LIFE ▷ HOTTEST-SPOT WINDING TEMPERATURE](#) actual value to observe the hottest spot temperature increases gradually. The simulated load to may be increased for a faster temperature rise.

When the hottest spot temperature reaches the [S4 ELEMENTS ▷ ▾ INSULATION AGING ▷ HOTTEST-SPOT LIMIT ▷ ▾ HOTTEST-SPOT LIMIT PICKUP](#) operating level, the element should operate.

- ▷ Verify all programmed relay operations as per FlexLogic™ settings.
- ▷ Verify that all the targets and messages are as expected and programmed.

The time delay can be verified with a watch as the delay is normally set in minutes.

7.5.19.3 Aging Factor Limit

The Aging Factor value is also a function of load, ambient temperature, and transformer ratings.

- ▷ Apply a current to Winding 1 Phase A to represent at least a 100% transformer load.
- ▷ Use the [A2 METERING ▷ ▾ LOSS OF LIFE ▷ ▾ INSULATION AGING FACTOR](#) actual value to observe that the aging factor increases gradually.
- ▷ You may want to increase the simulated load or the simulated or programmed ambient temperature to cause a faster increase.

When the aging factor reaches the [S4 ELEMENTS ▷ ▾ INSULATION AGING ▷ ▾ AGING FACTOR LIMIT ▷ ▾ AGING FACTOR LIMIT PICKUP](#) operating level, the element should operate.

- ▷ Verify all programmed relay operations as per FlexLogic™ settings.
- ▷ Verify that all the targets and messages are as expected and programmed.

The time delay can be verified with a watch as the delay is normally set in minutes.

7.5.19.4 Loss of Life Limit

Typical settings for the loss-of-life limit element dictate that either the limit be changed or the initial transformer loss-of-life be changed temporarily. Verification of this function is recommended by programming an initial loss-of-life above the element threshold. The element operates instantly as it has no associated time delay.

7.5.20 Tap Monitor Failure

The tap monitor failure element operates when the sensed resistance is 150% larger than the programmed values for the monitor circuit.

- ▷ Connect a resistance to simulate the tap changer resistance and increase this resistance until the element operates.
- ▷ Calculate that the resistance at which the element operated is 150% of the resistance that would be present at the maximum tap position.
- ▷ Verify all relay, targets and messages for correct operation per programmed values.

7.6 Auxiliary protection and monitoring functions

7.6.1 THD Level Scheme

7.6.1.1 Minimum Pickup

Testing of this element uses with the same setup used in testing the harmonic restraint percent differential elements (see FIGURE 7-1: *Test setup* on page 7-4).

To test the winding 1 THD element,

- ▷ Connect the composite current signal to terminals H1 and G1. Since the DC component actually consists of a half-wave rectified signal, it contains all even harmonics which the relay measures and operates on.
Note that the fundamental component is required to prevent saturation of the input CTs. Monitor the output relays as per the relay FlexLogic™ assignment.
- ▷ Set the fundamental component to rated CT secondary (1 or 5 A).
- ▷ Gradually increase the DC component to produce even harmonics until the THD level element operates.
- ▷ Display the total harmonic content under **A2 METERING ▷ ▾ HARMONIC CONTENT ▷ ▾ THD ▷ W1 THDα (2nd-21st)**.
The displayed value of THD at which operation took place should be the same as the programmed value.
- ▷ Check that the Trip, Pickup (and Alarm if selected) LEDs are on and one of the following is displayed:
LATCHED: W1 THD Level or **OPERATED: W1 THD Level**
- ▷ Lower the DC component until the element resets.
The reset value should be approximately 2% less than the operate value.
- ▷ Verify that the Phase, Pickup, and Alarm LEDs reset if the target function is set to **Self-resetting**.
The Trip LED should remain latched.

7.6.1.2 Operating time

To measure the basic operating time of this element,

- ▷ Preset a fundamental and DC component composite current signal to cause the element to operate.
- ▷ Using the setup of Figure 10-1, apply the current suddenly, at the same time as you trigger the timer.
The measured operating time should correspond to the time delay setting for the element.

7.6.1.3 Minimum Operating Current

The THD elements will only operate if the amplitude of the fundamental component is above the threshold setting.

To verify this threshold,

- ▷ Initially set the fundamental component above the threshold, with a harmonic content high enough to cause the element to operate.
- ▷ Now reduce the fundamental component only.
This will have the effect of increasing the THD level. When the fundamental component reaches a value below the set threshold, the element will reset.



If an RMS-responding meter is used to measure the current signal, the reading is the total value of current. To determine the fundamental component only, use the relay values in [A2 METERING ▷ CURRENT ▷ W1 CURRENT](#). These values represent the fundamental component only.

7.6.1.4 Other THD Elements

A THD element can be programmed for each winding of the transformer. Use the above procedures to verify the element(s) on the other winding(s).

7.6.2 Harmonic Derating Function

Testing of the harmonic derating function requires that accurate transformer parameters such as load losses at rated load and winding resistance be entered. This feature makes use of the harmonic derating factor (HDF) computed by the relay, using the harmonic content of the current signals and the transformer data (refer to IEEE C57.110-1986 for the computation method). Once the derating factor falls below a set value, the 745 can trip and/or alarm.

7.6.2.1 Operating level

To verify the correct operation of this element, a current signal containing harmonics must be introduced into one phase of the relay. Use FIGURE 7-1: *Test setup* on page 7-4 to accomplish this.

- ▷ Set the fundamental component at rated CT secondary into winding 1 phase A.
- ▷ Gradually increase the second harmonic component (and the rest of the even harmonics) while displaying the [A2 METERING ▷ ▾ HARMONIC CONTENT ▷ ▾ HARMONIC DERATING ▷ ▾ W1\(3\) HARMONIC DERATING FACTOR](#) value.
The element should operate when the displayed HDF equals the element setting.
- ▷ Check that the Trip, Pickup (and Alarm if selected) LEDs are on, and one of the following is displayed:

LATCHED: W1 Harm Derating or **OPERATED: W1 Harm Derating**

- ▷ Lower the DC component until the element resets.
The reset value should be approximately 2% larger than the operate value.
- ▷ Verify that the Pickup and Alarm LEDs reset if the target function is set to **Self-resetting**.
The Trip LED should remain latched.

7.6.2.2 Operating Time

To measure the basic operating time of this element,

- ▷ Preset a fundamental and DC component composite current signal to cause the element to operate.
- ▷ Using the setup of FIGURE 7-1: *Test setup* on page 7-4, apply the current suddenly, at the same time the timer is triggered.
The measured operating time should correspond to the time delay setting for the element.

7.6.3 Transformer Overload

The transformer overload element uses the phase A current of each winding to compute a transformer loading. The computation assumes a rated voltage on the winding, hence the loading is effectively a percent of rated load current.

7.6.3.1 Operating Level

- ▷ Inject a fundamental-frequency current into phase a of winding 1.
- ▷ Increase the current signal to a value just above the transformer overload pickup setting (take into account the CT ratio and the rated-MVA phase current to set the current correctly).
The element should operate after its set time delay.
- ▷ Check that the Trip, Pickup (and Alarm if selected) LEDs are on, and one of the following is displayed:
LATCHED: Xformer Overload or **OPERATED: Xformer Overload**
- ▷ Lower the current until the element resets.
The reset value should be approximately 97% of the operate value.
- ▷ Verify that the Pickup and Alarm LEDs reset if the target function is set to **Self-resetting**.
The Trip LED should remain latched.

7.6.3.2 Operating Time

Using the setup in *Frequency element testing* on page 7-44 with the interval timer enabled,

- ▷ Set the current level to 1.5 times the operate level of the element and apply suddenly by closing the double pole switch.
- ▷ Record the operate time and compare to the [S4 ELEMENTS ▷ ▾](#) [XFORMER OVERLOAD ▷ ▾](#) [TRANSFORMER OVERLOAD DELAY](#) setting.



The blocking from logic input, if enabled, can be tested as described in earlier tests for other elements.

7.7 Placing the Relay into Service

7.7.1 Precautions

The procedure outlined in this section is explicitly concerned with the 745 relay and does not include the operation/commissioning or placing into service of any equipment external to the 745. Users should have already performed such tests as phasing of CTs, ratio measurement, verification of saturation curve, insulation test, continuity and resistance measurements.

7.7.2 Procedure

- ▷ Restore all settings and logic to the desired in-service values.
- ▷ Verify against the check list prepared while testing the relay.
- ▷ Upload all the 745 setpoints to a computer file and print for a final inspection to confirm that all setpoints are correct.
- ▷ Set the 745 clock (date and time).
- ▷ Clear all historical values stored in the relay by entering “Yes” at **A3 EVENT RECORDER ▷▽ EVENT DATA CLEAR ▷ CLEAR EVENT RECORDER**.
- ▷ Remove all test connections, supplies, monitoring equipment from the relay terminals and relay panels except for equipment to be used to monitor first transformer energization.
- ▷ Restore all panel wiring to normal except for those changes made intentionally for the first energization (blocking of some tripping functions for example).
- ▷ Perform a complete visual inspection to confirm that the 745 is ready to be placed into service.
- ▷ Ensure that the relay is properly inserted in its case.
- ▷ Energize the relay power supply and verify that the Relay In Service LED is ON, and that the Self-Test Error LED is OFF, establishing that the relay is operating normally.



745 Transformer Protection System

Appendix

A.1 Change Notes

A.1.1 Revision History

Manual part no.	Revision	Release date	ECO
1601-0161-A1	3.0x	July 2, 2004	---
1601-0161-A2	3.0x	April 24, 2006	745-296
1601-0161-A3	5.0x	March 9, 2007	
1601-0161-A4	5.1x	July 31, 2007	745-311
1601-0161-A5	5.1x	March 24, 2008	
1601-0161-A6	5.1x	June 12, 2008	
1601-0161-A7	5.1x	June 29, 2009	
1601-0161-A8	5.2x	November, 2010	
1601-0161-A9	5.2x	July 13, 2011	

A.1.2 Changes to the 745 Manual

Table A-3: Major updates for 745 manual revision A9

Page (A8)	Page (A9)	Change	Description
Title	Title	Update	Manual part number to 1601-0161-A9
4-5/6	4-5/6	Correction	745 Access Switch location
5.3.5	5.3.5	Update	Supercap-backed internal clock

Table A-4: Major updates for 745 manual revision A8

Page (A7)	Page (A8)	Change	Description
Title	Title	Update	Manual part number to 1601-0161-A8
2-11	2-11	Revised	Dielectric Strength (Production Test)

Table A-4: Major updates for 745 manual revision A8

Page (A7)	Page (A8)	Change	Description
4-5/6	4-5/6	Correction	745 Access Switch location
6-19	6-19	Revised	Event Records
Table 6-1 Table 6-2 Table 6-4	Table 6-1 Table 6-2 Table 6-4	Revised	Test/Self-test information

Table A-5: Major updates for 745 manual revision A7

Page (A6)	Page (A7)	Change	Description
Title	Title	Update	Manual part number to 1601-0161-A7
General	General	Update	Restructure page numbering

Table A-6: Major updates for 745 manual revision A6

Page (A5)	Page (A6)	Change	Description
Title	Title	Update	Manual part number to 1601-0161-A6
5-152	5-152	Update	Replace drawing 5-16

Table A-7: Major updates for 745 manual revision A5

Page (A4)	Page (A5)	Change	Description
Title	Title	Update	Manual part number to 1601-0161-A5
2-16	2-16	Update	Change to DC Power Supply range - order table

Table A-8: Major updates for 745 manual revision A4

Page (A3)	Page (A4)	Change	Description
Title	Title	Update	Manual part number to 1601-0161-A4
3-10	3-36	Update	Changes to Typical Ground Input Connections table (table 3-2).
Ch 5	Ch 5	Addition	New Protection Element setting situated between "function" and "target" on all Protection Element settings pages.
5-11	5-101	Update	Changes to Transformer Types table (table 5-1).
5-39	5-134	Update	Changes to "Introduction to Elements" section.
5-45	5-139	Update	Changes to fig 5-9
5-90	5-192	Update	Changes to fig 5-49
6-22	6-227	Update	Change to Flash Message "Input Function is Already Assigned"
7-7	7-239	Update	Change to Equation 7.1

Table A-9: Major updates for 745 manual revision A3

Page (A2)	Page (A3)	Change	Description
Title	Title	Update	Manual part number to 1601-0161-A3
2-9	2-9	Update	Changes to ELECTROSTATIC DISCHARGE values

Table A-10: Major updates for 745 manual revision A2

Page (A1)	Page (A2)	Change	Description
Title	Title	Update	Manual part number to 1601-0161-A2.
2-3	2-3	Update	Updated Ordering section
2-5	2-5	Update	Updated Protection elements specifications section
---	3-5	Add	Added Ethernet connection section
4-7	4-7	Update	Updated Hardware section
4-13	4-13	Update	Updated Configuring Ethernet communications section
5-25	5-24	Update	Updated Communications section
---	6-3	Add	Added Network status section
6-19	6-20	Update	Updated Self-test errors section
7-4	7-4	Update	Updated Dielectric strength testing section

A.2 EU Declaration of Conformity

A.2.1 EU Declaration

EU DECLARATION OF CONFORMITY	
Applicable Council Directives:	73/23/EEC: The Low Voltage Directive 89/336/EEC: The EMC Directive
Standard(s) to Which Conformity is Declared:	
IEC 947-1: Low Voltage Switchgear and Controlgear	
IEC1010-1:1990+ A 1:1992+ A 2:1995 Safety Requirements for Electrical Equipment for Measurement, Control, and Laboratory Use	
CISPR 11 / EN 55011:1997: Class A – Industrial, Scientific, and Medical Equipment	
EN 50082-2:1997 Electromagnetic Compatibility Requirements, Part 2: Industrial Environment	
IEC100-4-3 / EN 61000-4-3: Immunity to Radiated RF	
EN 61000-4-6: Immunity to Conducted RF	
Manufacturer's Name:	General Electric Multilin Inc.
Manufacturer's Address:	215 Anderson Ave. Markham, Ontario, Canada L6E 1B3
Manufacturer's Representative in the EU:	Christina Bataller Mauleon GE Multilin Avenida Pinoa 10 48710 Zamudio, Spain Telephone: 34-94-4858835 Fax: 34-94-4858838
Type of Equipment:	Protection and Control Relay
Model Number:	745
First Year of Manufacture:	1998
I the undersigned, hereby declare that the equipment specified above conforms to the above Directives and Standards	
Full Name:	John Saunders
Position:	Manufacturing Manager
Signature:	
Place:	GE Multilin
Date:	08/20/1998

A.3 GE Multilin Warranty

A.3.1 Warranty Statement

General Electric Multilin (GE Multilin) warrants each device it manufactures to be free from defects in material and workmanship under normal use and service for a period of 24 months from date of shipment from factory.

In the event of a failure covered by warranty, GE Multilin will undertake to repair or replace the device providing the warrantor determined that it is defective and it is returned with all transportation charges prepaid to an authorized service centre or the factory. Repairs or replacement under warranty will be made without charge.

Warranty shall not apply to any device which has been subject to misuse, negligence, accident, incorrect installation or use not in accordance with instructions nor any unit that has been altered outside a GE Multilin authorized factory outlet.

GE Multilin is not liable for special, indirect or consequential damages or for loss of profit or for expenses sustained as a result of a device malfunction, incorrect application or adjustment.

For complete text of Warranty (including limitations and disclaimers), refer to GE Multilin Standard Conditions of Sale.



745 Transformer Protection System

Index

Numerics

2ND HARMONIC RESTRAINT	7-20, 7-21
5TH HARMONIC INHIBIT setpoints	5-56
5TH HARMONIC LEVEL setpoints	5-84
testing	7-53
5TH HARMONIC RESTRAINT	7-21, 7-22

A

AGING FACTOR LIMIT setpoints	5-92
testing	7-54
ALARM INDICATOR	4-3
AMBIENT TEMPERATURE	5-39, 7-13, 7-14
ANALOG INPUT setpoints	5-94
specifications	2-6
typical wiring	3-16
ANALOG OUTPUTS commissioning	7-14, 7-15
connection	3-17
setpoints	5-43, 5-108
specifications	2-9
typical wiring	3-17
ANSI CURVES constants	5-59
trip times	5-59
AUTO-CONFIGURATION	5-6
AUTOMATIC TRANSFORMATION	7-11

B

BLOCKING FROM LOGIC INPUTS	7-23, 7-24
BOOTWARE REVISION	6-21

C

CASE	
description	3-1
dimensions	3-1
mounting	3-2, 3-3
CLOCK	5-29
COMMISSIONING	
conventions	7-2
preliminary work	7-5
test equipment	7-3
COMMUNICATIONS	
DNP	5-27
RS232	3-19, 3-20, 4-9, 4-13, 4-15
RS422	3-17, 3-19
RS485	3-17, 3-18, 4-9, 4-10, 4-13, 4-15
setpoints	5-26, 5-27
wiring	4-9, 4-10
CONDITIONS	4-3
CONTROL POWER	2-5, 3-15
CT INPUTS	3-12
CURRENT DEMAND	
setpoints	5-95
CURVES	
definite time	5-59
FlexCurves™	5-59
IAC	5-61
IEC	5-60
IEEE	5-59
types	5-58

D

DEFAULT MESSAGES	5-30
DEFINITE TIME CURVE	5-59
DEMAND METERING	
setpoints	5-41
DIELECTRIC STRENGTH TESTING	7-6
DIFFERENTIAL	
instantaneous differential	5-57
percent differential	5-49
setpoints	5-48
DIFFERENTIAL BLOCKED INDICATOR	4-3
DISPLAY	4-2
DNP COMMUNICATIONS	5-27
DRY CONTACT CONNECTIONS	3-15
DYNAMIC CT RATIO MISMATCH	5-6

E

ELEMENTS	
introduction	5-46
setpoints	5-46
ENERGIZATION DETECTION SCHEME	7-22
ENERGIZATION INHIBIT	5-53
ENERGY DATA CLEAR	6-16
ENERVISTA VIEWPOINT WITH THE 745	4-40
ENTERING TEXT	4-5
EQUATIONS	
definite time curve	5-59
FlexCurve™	5-59
EU DECLARATION OF CONFORMITY	A-4
EVENT CAUSES	6-19
EVENT RECORDER	
setup	5-33

F

FACTORY SERVICE	5-112
FAULT VALUES	5-110
FIFTH HARMONIC INHIBIT	
setpoints	5-56
FIFTH HARMONIC LEVEL	
setpoints	5-84
testing	7-53
FIFTH HARMONIC RESTRAINT	7-21
FIRMWARE, UPGRADING	4-27
FLEXCURVES™	
equation	5-59
setpoints	5-38
FLEXLOGIC™	
example	5-101, 5-102
gates	5-100
input types	5-100
introduction	5-99
output types	5-100
rules	5-100
FREQUENCY	
commissioning	7-43, 7-44
setpoints	5-78
FREQUENCY DECAY	
setpoints	5-80
testing	7-50
FRONT PANEL	4-1
FRONT PANEL PORT	3-19

G

GROUND INDICATOR	4-3
GROUND INSTANTANEOUS OVERCURRENT	
setpoints	5-71
specifications	2-7

testing	7-35, 7-36
GROUND OVERCURRENT SETPOINTS	5-69
GROUND TIME OVERCURRENT	
setpoints	5-70
specifications	2-7
testing	7-32

H

HARDWARE REVISION	6-21
HARMONIC DERATING	
correction	5-64
setpoints	5-89
testing	7-57
HARMONIC INHIBIT	5-52
HARMONICS	5-38, 5-88
HI-POT TESTING	3-20
see DIELECTRIC STRENGTH TESTING	
HOTTEST-SPOT LIMIT	
setpoints	5-91
testing	7-54

I

IAC CURVES	
constants	5-61
description	5-61
trip times	5-61
IEC CURVES	
constants	5-60
description	5-60
trip times	5-60
IED SETUP	4-11
IEEE CURVES	5-59
IN SERVICE INDICATOR	4-2
INDICATORS	
see LEDs and entries for individual indicators	
INPUTS	
AC voltage	3-14
commissioning	7-9
specifications	2-5
INSERTION	3-3
INSPECTION CHECKLIST	1-1
INSTALLATION	
electrical	3-7
mechanical	3-1
setpoints	1-9, 5-31
INSTANTANEOUS DIFFERENTIAL	
setpoints	5-57
specifications	2-6
testing	7-23
INSULATION AGING	
setpoints	5-90
specifications	2-9
testing	7-54

INVERSE CURVE 1	5-85
IRIG-B	3-20

K

KNEEPOINT	7-20
-----------------	------

L

LEDs	
alarm	4-3
description	4-2
differential blocked	4-3
ground	4-3
in logic diagrams	5-47
in service	4-2
load-limit reduced	4-3
LOCAL	4-3
message	4-3
phase A	4-3
phase B	4-3
phase C	4-3
pickup	4-3
self-test error	4-2
setpoint group 1	4-3
system status	4-3
test mode	4-2
transformer de-energized	4-3
transformer overload	4-3
trip	4-3
LOAD-LIMIT REDUCED INDICATOR	4-3
LOCAL INDICATOR	4-3
LOCAL RESET MODE	7-17
LOGIC	5-47
LOGIC INPUTS	3-14
commissioning	7-7
setpoints	5-44
specifications	2-6
wiring	3-14
LOSS-OF-LIFE	5-90
LOSS-OF-LIFE LIMIT	5-93, 7-55

M

MANEUVERING	1-3
MEASUREMENT UNITS	5-47
MESSAGE INDICATOR	4-3
MINIMUM OPERATING CURRENT	7-57
MINIMUM PICKUP	7-16, 7-23, 7-56

N

NAMEPLATE	1-1
NEGATIVE SEQUENCE INSTANTANEOUS OVERCURRENT	

setpoints	5-77
specifications	2-7
testing	7-42
NEGATIVE SEQUENCE OVERCURRENT	5-76
NEGATIVE SEQUENCE TIME OVERCURRENT	
setpoints	5-76
specifications	2-7
testing	7-39
NEUTRAL INSTANTANEOUS OVERCURRENT	
setpoints	5-68
specifications	2-7
testing	7-31, 7-32
NEUTRAL OVERCURRENT	5-66
NEUTRAL TIME OVERCURRENT	
setpoints	5-66
specifications	2-7
testing	7-29
NUMERICAL SETPOINTS	1-6

O

ONLOAD TAP CHANGER	5-37
OPERATING TIME	7-18
ORDER CODES	2-3
OUTPUT RELAYS	
commissioning	7-7, 7-8
default FlexLogic™	5-103
description	3-16
setpoints	5-102, 5-107
specifications	2-9
typical wiring	3-16
OVERCURRENT	
ground instantaneous	5-71
ground time	5-70
negative sequence instantaneous	5-77
negative sequence time	5-76
neutral instantaneous	5-68
neutral time	5-66
phase	5-58
OVERCURRENT CURVES	
definite time	5-59
FlexCurves™	5-59
IEEE	5-59
OVEREXCITATION	
5th harmonic level	5-84
description	5-83
setpoints	5-84
specifications	2-8
volts-per-hertz	5-85
OVERFREQUENCY	
setpoints	5-82
specifications	2-8
testing	7-47
OVERVIEW	2-1

P

PANEL CUTOUT	3-2
PASSCODE	
changing	1-9, 1-10, 1-11
security	1-9, 1-10
setpoints	5-25
PERCENT DIFFERENTIAL	
dual-slope characteristic	5-50
harmonic restrained	7-16
operating principle	5-49
setpoints	5-49
specifications	2-6
zones of protection	5-74
PHASE A INDICATOR	4-3
PHASE ANGLE CORRECTION	5-10
PHASE B INDICATOR	4-3
PHASE C INDICATOR	4-3
PHASE INSTANTANEOUS OVERCURRENT	
setpoints	5-65
specifications	2-7
testing	7-27, 7-28
PHASE OVERCURRENT	5-58
PHASE SEQUENCE	3-12
PHASE SHIFTS	
description	5-24
table	5-24
three-phase transformers	5-8
PHASE TIME OVERCURRENT	
setpoints	5-63
specifications	2-7
testing	7-25
PHASORS	
ABC sequence	5-9
ACB sequence	5-10
PICKUP INDICATOR	4-3
PLACING THE RELAY INTO SERVICE	7-60
PREFault VALUES	5-110
PREFERENCES	5-25
PROTECTION SCHEMES	
5th harmonic	5-84, 7-53
energization detection	7-22
features	2-2
frequency decay	5-80
frequency decay rate	7-50
ground instantaneous overcurrent	5-71, 7-35, 7-36
ground time overcurrent	5-70, 7-32
harmonic restrained percent differential	7-16
instantaneous differential	5-57, 7-23
insulation aging	7-54
negative sequence instantaneous overcurrent	5-77, 7-42
negative sequence time overcurrent	5-76, 7-39
neutral instantaneous overcurrent	5-68, 7-31, 7-32
neutral time overcurrent	5-66, 7-29
overfrequency	7-47
phase instantaneous overcurrent	5-65, 7-27, 7-28

phase time overcurrent	5-63, 7-25
restricted ground.....	5-72
restricted ground fault	7-36, 7-38
specifications	2-6
THD level	5-88, 7-56
underfrequency	5-79, 7-44, 7-47
volts-per-hertz.....	5-85, 7-52

R

REAR TERMINAL ASSIGNMENTS.....	3-8
REAR TERMINAL LAYOUT	3-7
REMOTE RESET MODE	7-18
RESETTING.....	5-29
RESISTANCE GROUNDED WYE WINDING	5-73
RESTRICTED GROUND	
implementation	5-74
setpoints.....	5-72
settings example	5-74
testing	7-36, 7-38
zones of protection	5-74
RESTRICTED GROUND FAULT	
specifications	2-7
RS232 COMMUNICATIONS	
configuring with EnerVista 745 Setup	4-13, 4-15
connections	4-9
wiring.....	3-19
RS422 COMMUNICATIONS	3-17, 3-19
RS485 COMMUNICATIONS	3-18
configuring with EnerVista 745 Setup	4-13, 4-15
connections	4-9, 4-10
wiring.....	3-17
RTD	
calibration	7-13
driver/sensor	3-16
measured temperature	7-13
resistance vs. temperature.....	5-40

S

S1 745 SETUP.....	5-25
S2 SYSTEM SETUP.....	5-34
S3 LOGIC INPUTS.....	5-44
S4 ELEMENTS	5-46
S5 OUTPUTS	5-99
S6 TESTING.....	5-107
SCRATCHPAD	5-31
SECOND HARMONIC RESTRAINT	7-20
SELF-TEST ERROR INDICATOR	4-2
SELF-TEST ERRORS.....	6-25
SERVICING	7-60
SETPOINT ENTRY	4-5, 5-4
SETPOINT GROUP	5-47
SETPOINT GROUP 1 INDICATOR	4-3
SETPOINT MESSAGE MAP	5-1

SETPOINT WRITE ACCESS	5-4
SETPOINTS	
745 setup	5-25
access jumper	1-6
changing	1-6
elements	5-46
entering with EnerVista 745 Setup software	4-19
groups	5-1
in logic diagrams	5-47
loading from a file	4-26
logic inputs	5-44
messages	5-1
numerical	1-7
outputs	5-99
saving to a file	4-27
system setup	5-34
testing	5-107
text-based	1-7
SIMULATION	5-108
SINGLE LINE DIAGRAM	2-3
SOFTWARE	
entering setpoints	4-19
hardware requirements	4-8
installation	4-10
loading setpoints	4-26
overview	4-8
saving setpoints	4-27
serial communications	4-13, 4-15
SOFTWARE REVISION	6-21
SOLID STATE OUTPUT TEST CIRCUIT	7-18
SOLID STATE TRIP OUTPUT	3-17
SPECIFICATIONS	2-5
STATUS INDICATORS	4-2
SYSTEM STATUS INDICATORS	4-3

T

TAP CHANGER FAILURE	5-97
TAP MONITOR FAILURE	7-55
TAP POSITION	7-15
TAP POSITION INPUT	3-16, 5-8
TARGET MESSAGES	6-23
TEMPERATURE	
ambient	5-39, 7-13, 7-14
operating	2-10
RTD	7-13
storage	2-10
TEST MODE INDICATOR	4-2
TEST SETUP	7-25
TEXT SETPOINTS	1-7
THD LEVEL	
setpoints	5-88
testing	7-56
TIME DELAYS	5-47
TIMERS	5-106
TOC CURVES	

IAC	5-61
IEC	5-60
TRACE MEMORY	5-105
TRANSFORMER	5-34
TRANSFORMER DE-ENERGIZED INDICATOR	4-3
TRANSFORMER OVERLOAD	5-96, 7-58
TRANSFORMER OVERLOAD INDICATOR	4-3
TRANSFORMER POLARITY	3-12
TRANSFORMER TYPES	5-13
TRANSFORMER-TYPE SELECTION	7-11
TRIP INDICATOR	4-3
TYPICAL WIRING DIAGRAM	3-10

U

UNDERFREQUENCY	
setpoints	5-79
specifications	2-7
testing	7-44, 7-47
UNPACKING THE RELAY	1-1
UPGRADE OPTIONS	5-31
UPGRADING FIRMWARE	4-27

V

VIRTUAL INPUTS	5-45
VIRTUAL OUTPUTS	5-106
VOLTAGE INPUT	3-14, 5-39
commissioning	7-10
VOLTS-PER-HERTZ	
setpoints	5-85
testing	7-52

W

WARRANTY	A-5
WEBSITE	1-1
WET CONTACT CONNECTIONS	3-15
WIRING DIAGRAM	3-10
WITHDRAWAL	3-3
WYE / DELTA TRANSFORMER	5-10

Z

ZERO-SEQUENCE COMPONENT REMOVAL	5-11, 7-12
ZERO-SEQUENCE CT INSTALLATION	3-14