

LUFP7 Telemecanique

User's Manual

Gateway
Profibus-DP / Modbus RTU

Version 2.0
10/2006



Merlin Gerin

Modicon

Square D

Telemecanique

Schneider
 **Electric**

Table of Contents

Safety Information	4
Disclaimer	4
1. Introduction	6
1.1. Introduction to the User's Manual	6
1.2. Introduction to the LUF7 Gateway	8
1.3. Terminology.....	8
1.4. Introduction to the Communication "System" Architecture.....	9
1.5. Principle of Gateway Configuration and Operation	10
2. Hardware Implementation of the LUF7 Gateway	12
2.1. On Receipt	12
2.2. Introduction to the LUF7 Gateway	12
2.3. Mounting the Gateway on a DIN Rail	13
2.4. Powering the Gateway	14
2.5. Connecting the Gateway to the Modbus Network	14
2.5.1. Examples of Modbus Connection Topologies.....	15
2.5.2. Pin Outs	17
2.5.3. Wiring Recommendations for the Modbus Network.....	18
2.6. Connecting the LUF7 gateway to the Profibus-DP Network.....	20
2.6.1. Pin Outs	20
2.6.2. Wiring Recommendations for the Profibus-DP Network	21
2.7. Configuring the Profibus-DP Communication Features	23
2.7.1. Encoding the Gateway Address.....	23
2.7.2. No Internal Line Termination.....	24
3. Signaling	25
4. Software Implementation of the Gateway	27
4.1. Introduction.....	27
4.1.1. System Architecture.....	27
4.1.2. Configuring the Motor Starters	28
4.1.3. Modbus Cycle Time	28
4.1.4. Managing Degraded Modes With the Gateway Default Configuration	28
4.2. Gateway Configuration under PL7 PRO and SyCon	33
4.2.1. Setting Up the Hardware Configuration under PL7 PRO	33
4.2.2. Creating a Profibus-DP Network under SyCon	34
4.2.3. Selecting and Adding the Profibus-DP Master Station ..	34
4.2.4. Setting up the Gateway Description Files	35
4.2.5. Selecting and Adding the Gateway to the Profibus-DP Network	36
4.2.6. Editing and Configuring the Gateway	36
4.2.7. Saving and Exporting the Profibus-DP Network Configuration	38
4.2.8. Importing the Configuration of the Profibus-DP Network under PL7 PRO	38
4.2.9. Configuring the Gateway I/O under PL7 PRO	39
4.2.10. Validating and Saving the Configuration of the TSX PBY 100 Coupler.....	41
4.2.11. Allocating Symbols to the Gateway Inputs and Outputs	41
4.2.12. Using and Monitoring the TSX PBY 100 Coupler Configuration	42
4.2.13. Developing a Profibus-DP Application	42
4.3. Description of Services Assigned to Gateway I/O.....	43
5. Gateway Initialization and Diagnostics	44
5.1. Full Management.....	44
5.1.1. Profibus-DP master command Word	45
5.1.2. Gateway Status Word	45
5.2. Diagnostic and Control	45
5.2.1. Profibus-DP master command Word	45
5.2.2. Gateway Status Word	46
5.3. Simplified Operation.....	46
5.4. Description of the Profibus-DP master command Word Erreur ! Signet	
5.5. Description of the Gateway Status Word Erreur ! Signet non défini.	
6. Configuring the Gateway	51
6.1. Connecting the Gateway to the Configuration PC	51
6.1.1. Pin Outs	52
6.1.2. RS-232 Link Protocol.....	52
6.2. Installing ABC-LUF7 Config Tool.....	53
6.3. Connecting to / Disconnecting from the Gateway Erreur ! Signet non d	
6.4. Importing the Gateway Configuration Erreur ! Signet non défini.	
6.5. Transferring a Configuration to the Gateway Erreur ! Signet non défini	
6.6. Monitoring the Content of the Gateway's Memory	56
6.7. Deleting a Modbus Slave	59
6.8. Adding a Modbus Slave	60
6.9. Changing the Periodic Data Exchanged with a Modbus Slave.....	62
6.9.1. Replacing a Periodic Input Data Element	62
6.9.2. Replacing a Periodic Output Data Element	63
6.9.3. Increasing the Amount of Periodic Input Data	64
6.9.4. Increasing the Amount of Periodic Output Data	69
6.10. Deleting Aperiodic Parameter Data	74
6.11. Changing a Modbus Slave Configuration	76
6.11.1. Changing the Name of a Modbus Slave	77
6.11.2. Changing the Address of a Modbus slave	77
6.11.3. Changing the Name of a Modbus Command or Transaction	78
6.12. Adding and Setting Up a Modbus Command.....	79
6.12.1. With the TeSys U Motor Starters	79
6.12.2. With a Generic Modbus Slave	82
6.12.3. Adding a Special Modbus Command	95
6.13. Configuring the General Characteristics of the Gateway .	101
6.13.1. "Fieldbus" Element.....	101
6.13.2. "ABC LUF7" Element.....	102
6.13.3. "Sub-Network" Element	104
6.14. Adding a Broadcaster Node	106
Appendix A: Technical Characteristics	107
Appendix B: LUF7 Gateway GSD File	113
Appendix C: Default Configuration	117
Appendix D: Sample Use under PL7 PRO	120
Appendix E: Profibus-DP Data and Diagnostics	128
Appendix F: Modbus Commands	132
Appendix G: Concept and Quantum PLC	136
Index	137
Glossary	138

Safety Information

NOTICE:

Read these instructions carefully, and look at the equipment to become familiar with the device before trying to install, operate, or maintain it. The following special messages may appear throughout this documentation or on the equipment to warn of potential hazards or call attention to information that clarifies or simplifies a procedure.



These are the safety alert symbols. They are used to alert you to potential personal injury hazards. Obey all safety messages following these symbols to avoid death, injury, or equipment damage.



DANGER

DANGER indicates an imminently hazardous situation, which, if not avoided, will result in death, serious injury, or equipment damage.

WARNING

WARNING indicates a potentially hazardous situation, which, if not avoided, can result in death, serious injury, or equipment damage.

CAUTION

CAUTION indicates a potentially hazardous situation, which, if not avoided, can result in injury or equipment damage.

Disclaimer

PLEASE NOTE:

Only qualified personnel should service electrical equipment. No responsibility is assumed by Schneider Electric for any consequences arising out of the use of this material or the associated User Manual. This document is not intended as an instruction manual for untrained persons.

© 2006 Schneider Electric. All Rights Reserved.

About the book

Validity Note

This document applies to all V2 gateways.

Functions and improvements compared to previous product version:

- Increased number of instances/transactions from 50 to approximately 100.
- Password protection for configuration upload/download in LUF9.
- Sub-network Line Analyzer debugging feature.
- Improved response trigger behaviour.
- MS Windows association of configuration (*.CFG) files possible. A double-click will automatically open the configuration file in the ABC-LUF9 Config Tool.
- Extended display functionality in node monitor (updated column width and hexadecimal / decimal display).
- Simplified usability. New and improved options menu.

The data and illustrations in this manual are not contractual. We reserve the right to modify our products in line with our policy of continuous development. The information given in this document may be modified without notice and must not be interpreted as binding in the part of Schneider Electric.

Related Documents

Title of Documentation	Reference Number
AnyBus Communicator – User Manual	ABC_User_Manual.pdf (SDN-7061-059)
Safety Guidelines for the Application, Installation, and Maintenance of Solid State Control	NEMA ICS 1.1 (latest edition)
Safety Standards for Construction and Guide for Selection, Installation and Operation of Adjustable-Speed Drive Systems	NEMA ICS 7.1 (latest edition)
Modbus User Guide	TSX DG MDB E
Modicon Modbus Protocol Reference Guide	PI-MBUS-300 Rev. J

Product Related Information

Schneider Electric is in no way responsible for any errors in this document. Please contact us if you have any suggestions for improvements or modifications, or if you find any errors in this publication.

No parts of this document may be reproduced in any form or by any means whatsoever (electronic, mechanical or photocopying) without the prior authorization of Schneider Electric.

All pertinent state, regional, and local safety regulations must be observed when installing and using this product. For safety reasons and to ensure compliance with the documented system data, only the manufacturer should perform repairs to components.

User Comment

This is a “living” document. As such, it will be revised from time to time to add new content or to revise existing content as considered necessary. This manual has been written for you. We welcome your questions and comments about this document. Please send your comments by e-mail to techpub@schneider-electric.com

1. Introduction

1.1. Introduction to the User's Manual

- Chapter 1** describes the gateway, the user guide that comes with it and the terms used in it.
- Chapter 2** gives an introduction to the gateway and describes all the items used when setting it up, both inside (thumb wheels) and outside (cables and connectors) the gateway.
- Chapter 3** describes the six LEDs on the front of the gateway.
- Chapter 4** describes the successive steps for setting the gateway up with its default configuration, with a PLC using Profibus-DP. LUF7 gateways are shipped pre-configured to allow you to interface a Profibus-DP master with 8 predefined Modbus slaves (TeSys U motor starters).
- Chapter 5** describes two registers in the gateway's memory reserved for initializing and carrying out diagnostics on the gateway. They are only exchanged between the Profibus-DP master and the gateway.
- Chapter 6** describes how to use the "ABC-LUF7 Config Tool" software application, which allows you to modify or create a new configuration for the gateway and shows the various features of this software (add or remove a Modbus slave, add or change a Modbus command, etc.).
- This chapter also shows the changes to be made to software implementation operations in SyCon and PL7 PRO.
- Appendix A** describes the technical aspects of both the gateway and the Profibus-DP and Modbus RTU networks it is interfaced with.
- Appendix B** details and describes the content of the GSD file shipped with the gateway. The file can be used for the setup tools to recognize the LUF7 gateway as a Profibus-DP subscriber with communication features of its own.
- Appendix C** describes the main features of the default configuration of the LUF7 gateway. However, it does not go into ABC-LUF7 Config Tool in detail.
- Appendix D** gives an advanced example using the LUF7 gateway's default configuration. This example exploits the command and monitoring registers for 8 TeSys U motor starters and uses the aperiodic read and writes services used to access the value of any motor starter parameter.
- Appendix E** repeats the information described in the *Implementation manual* of the TSX PBY 100 coupler for Premium PLCs. It also provides the values of these data and the results of these diagnostics for the LUF7 gateway.
- Appendix F** describes the content of the Modbus command frames supported by the LUF7 gateway.
- Appendix G** explains about Concept data type with a Quantum PLC.

1. Introduction

Quick Access to Critical Information

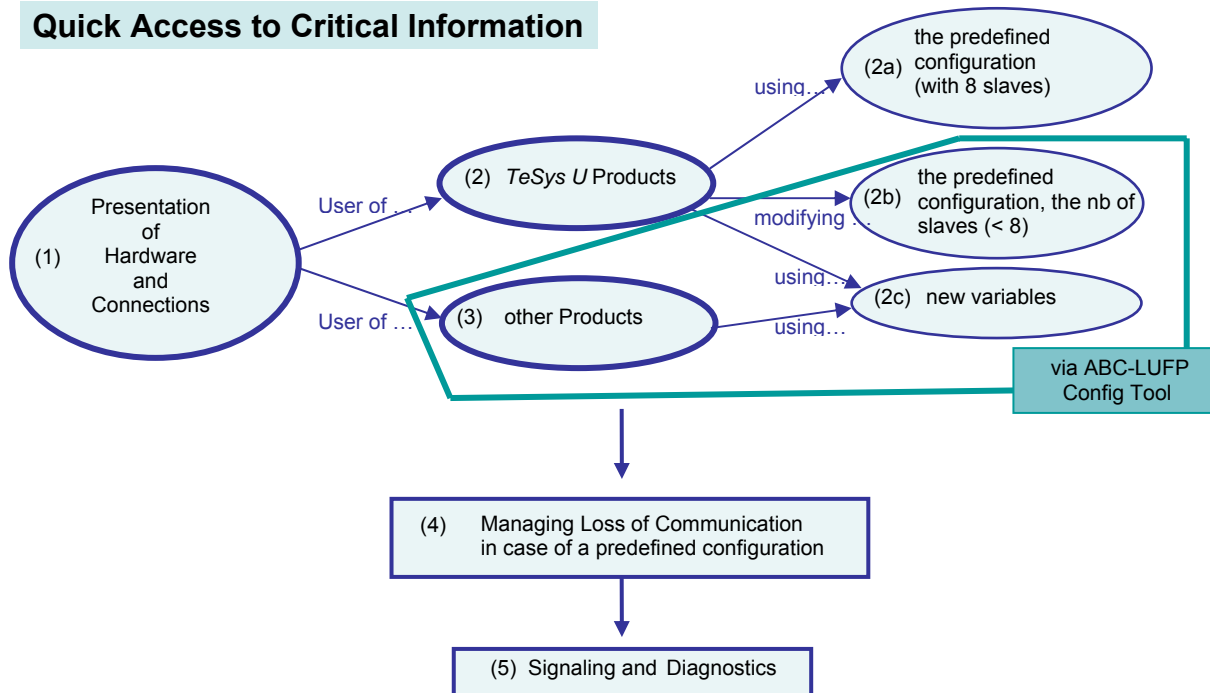

(1) Presentation of Hardware and Connections

- **See Chapter 2**
- powering,
 - mounting,
 - Modbus connecting,
 - Profibus connecting,
 - Transmission speed and address selecting

(2) User of TeSys U Products

(2a) with 8 slaves

- **See Chapter 4**

(2b) reducing the number of slaves

- **See Chapter 6**
- Using ABC-LUFP Config Tool:
- install (6.2),
 - connect (6.1),
 - remove slaves (6.6)

(2c) access to new variables

- **See Chapter 6**
- Using ABC-LUFP Config Tool to access other registers than standard 704 (Command) and 455 (Status)
- with the same request:
- replace a register with another (for instance 455 with 458)
 - expand the size (the number of registers)
- with a supplementary request:
- add-up extra commands
 - other operations (6.7 to 6.11)

(3) User of other Generic Modbus Products

- **See Chapter 6 (6.7 to 6.11, 6.11.2)**
- Select between:
- adapting the predefined configuration provided with the gateway, if close enough to that you wish (1 register to read and 1 to write, 1 register address to change), or
 - building up your own configuration from scratch (see ABC User Manual)

(4) Loss of Communication

- **See Chapter 4.1.4.1 and Chapter 6.11.2.2**
- The variables described are:
- **Reconnect time** (unit = 10ms, default value = 10s)
 - **Retries** (default value = 3)
 - **Timeout time** (unit = 10ms, default value = 1s)

(5) Signaling of faults and status, Diagnostics

- **See Chapter 3**
- Signaling defaults and gateway status by LEDs on the front
- **See Chapter 5**
- Gateway initializing mode and description of diagnostics information

1. Introduction

1.2. Introduction to the LUF7 Gateway

The LUF7 gateway allows a master located on a Profibus-DP network to enter into a dialogue with the slaves on a Modbus RTU network. This is a generic protocol converter operating in a way which is transparent to the user.

This gateway allows you to interface many products marketed by *Schneider Electric* with a Profibus-DP network. These include TeSys U motor starters, Altivar drivers and Altistart soft start- soft stop units.

1.3. Terminology

Throughout this document, the term “user” refers to any person or persons who may need to handle or use the gateway.

The term “RTU”, which refers to the Modbus RTU communication protocol, will be omitted most of the time. As a result, the simple term “Modbus” will be used to refer to the Modbus RTU communication protocol.

As it is still the case with all communication systems, the terms “input” and “output” are somewhat ambiguous. To avoid any confusion, we use a single convention throughout this document. So the notions of “input” and “output” are always as seen from the PLC, or the Profibus-DP master.

Hence, an “output” is a command signal sent to a Modbus slave, whereas an “input” is a monitoring signal generated by this same Modbus slave.

The diagram below shows the flows of “inputs” and “outputs” exchanged between a Profibus-DP master and Modbus RTU slaves via the LUF7 gateway:

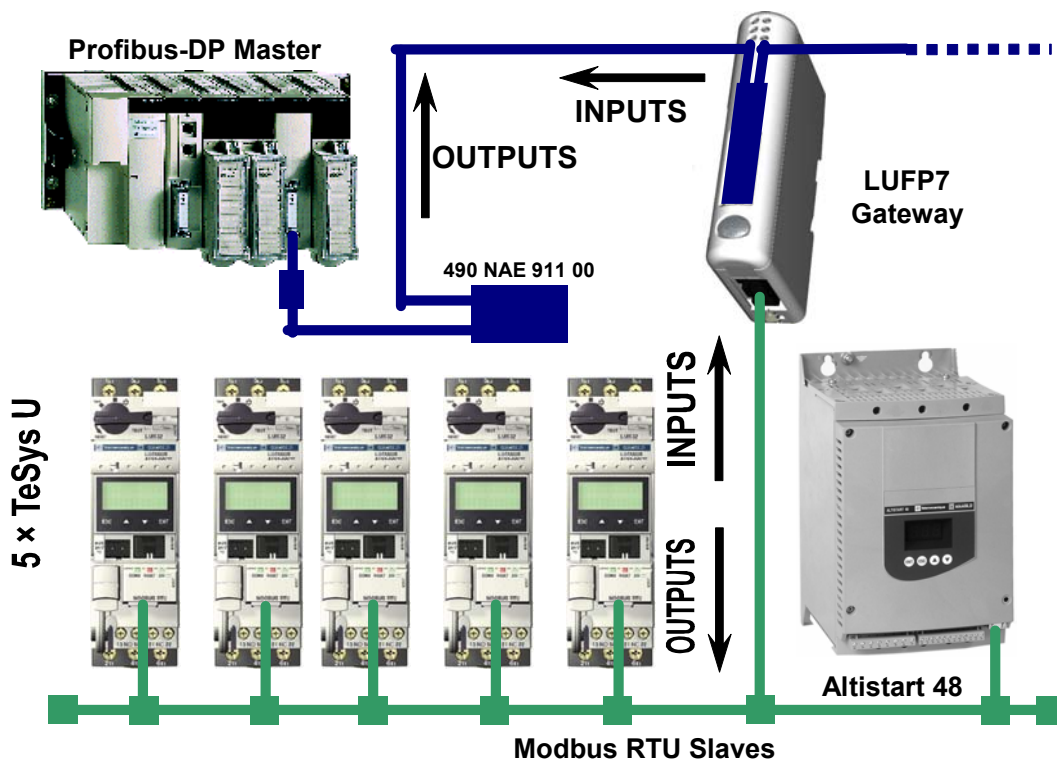

NOTE: For more explanation about specific terms, refer to the Glossary at the end of this guide.

1. Introduction

1.4. Introduction to the Communication “System” Architecture

Each LUF7 Profibus-DP / Modbus RTU gateway allows one of the PLCs on the Profibus-DP network to command, control and configure up to 8 Modbus slaves. 50 commands (Modbus requests) can be distributed over a maximum of 8 slaves. If there are more than 8 Modbus slaves, you will need to use an appropriate number of LUF7 gateways.

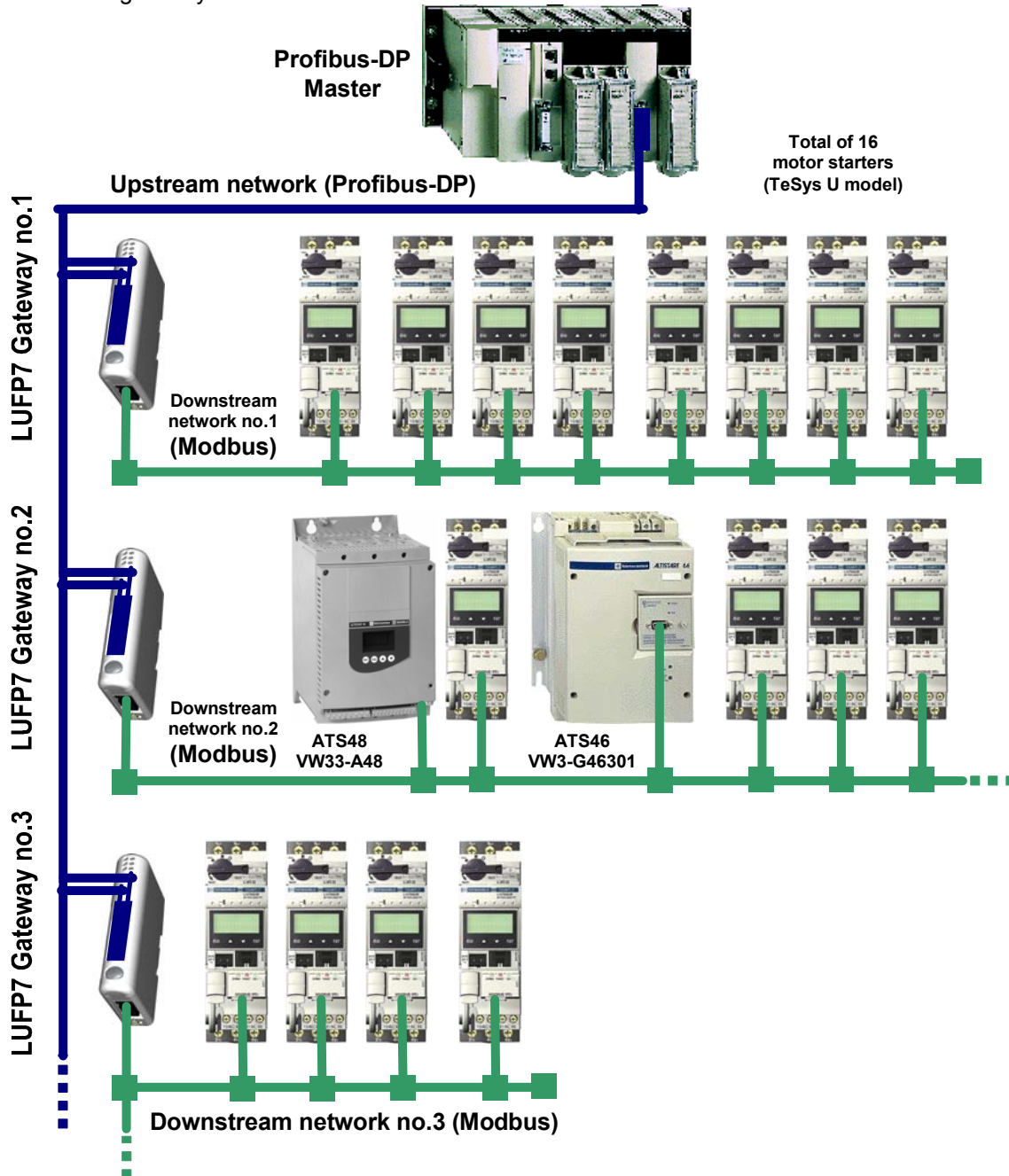

1. Introduction

The LUF7 gateway behaves both as a Profibus-DP slave on the upstream network and as a Modbus RTU master on the downstream network.

See Appendix A: Technical Characteristics if you would like to read about the technical communication characteristics of the LUF7 gateway.

The gateway can carry out its data exchanges (inputs and outputs of all types) with the Modbus slaves cyclically, aperiodically or in an event-driven way. All of these Modbus exchanges make up the gateway's "Modbus scanner" and we use the "ABC-LUF7 Config Tool" software application to configure this scanner's exchanges. Every item of data exchanged in this way is made available for the Profibus-DP master, which can gain access to it in a number of ways (cyclical, aperiodic or event-driven exchange).

The diagram on the preceding page illustrates the distribution of several slaves throughout three downstream Modbus RTU networks, each of these networks being interfaced with the Profibus-DP master PLC using an LUF7 gateway.

1.5. Principle of Gateway Configuration and Operation

The gateway is part of a family of products (referred to as LUF7●) designed to meet generic needs for connection between two networks using different communication protocols.

The software elements common to all these gateways (a configuration tool known as "ABC-LUF7 Config Tool" and the on-board Modbus software) cohabit with the specific features of the network upstream of each of them (Profibus-DP in the case of the LUF7 gateway) generically. This is one of the reasons why the interfacing between the upstream network and the Modbus network is carried out entirely via the gateway's physical memory.

1. Introduction

Each LUF7 gateway is shipped pre-configured so as to make it easier to operate and the factory settings can be used as a basis for a configuration which will best meet the user's expectations. The typical operations applicable to this default configuration are described in chapter 6.

The Profibus-DP network is totally separate from the Modbus network. The frames on a network are not directly "translated" by the gateway to generate frames on the other network. Instead, the exchanges between the content of the gateway's memory and the Modbus slaves make up a system which is independent of the one which is entrusted with managing the exchanges between this same memory and the Profibus-DP master. The system guarantees the coherence of data exchanged within the shared memory.

You must check that the size of the Profibus-DP data corresponds to the size of the memory used for the Modbus exchanges, because the gateway configures its Profibus-DP exchanges on the basis of the memory used by the Modbus frames. If the sizes do not match, the fieldbus Diag LED n°4 blinks at 1 Hertz frequency, cyclic Modbus exchanges are enabled and write-access Modbus registers are set to 0.

The example which follows illustrates the independent management of each of the two networks:

— Managing Gateway ↔ Modbus slaves exchanges —

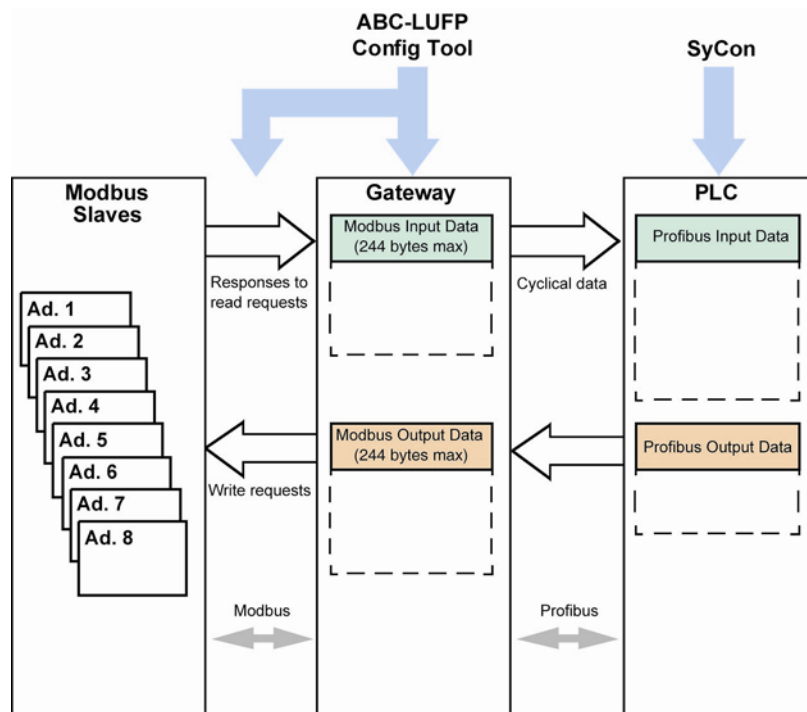

- (1) The sum of Input Data and Output Data is limited to 416 bytes max.

2. Hardware Implementation of the LUF7 Gateway

2.1. On Receipt

After opening the packaging, check that you have an LUF7 Profibus-DP / Modbus RTU gateway equipped with a detachable power connector.

2.2. Introduction to the LUF7 Gateway

The cables and other accessories for connecting to Profibus-DP and Modbus networks need to be ordered separately.

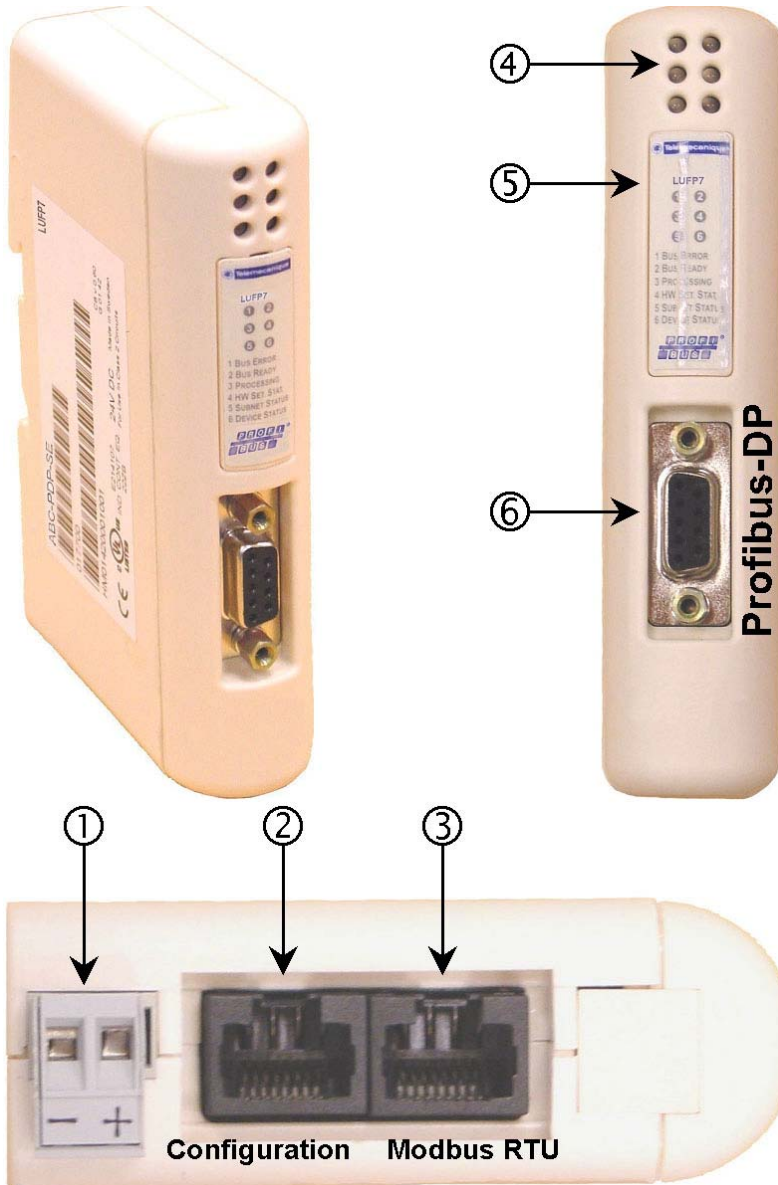

Legend:

- ① Detachable power connector for the gateway ($\text{---} 24\text{V} \pm 10\%$).
- ② Female RJ45 connector to a PC running ABC-LUF7 Config Tool configuration software.
- ③ Female RJ45 connector for the downstream Modbus RTU network.
- ④ Six diagnostic LEDs.
- ⑤ Removable cover for the coding wheels used to configure the gateway, shown and described in chapter 2.7. The label describing the LEDs is stuck onto this cover.
- ⑥ Female Profibus-DP connector.

2. Hardware Implementation of the LUF7 Gateway

The LUF7 enables communications between a Profibus network and Modbus devices for the purpose of industrial automation and control. As with any component used in an industrial control system, the designer must evaluate the potential hazards arising from use of the LUF7 in the application.

⚠ WARNING

LOSS OF CONTROL

- The designer of any control scheme must consider the potential failure modes of control paths and, for certain critical control functions, provide a means to achieve a safe state during and after a path failure. Examples of critical control functions are emergency stop and overtravel stop.
- Separate or redundant control paths must be provided for critical control functions.
- System control paths may include communication links. Consideration must be given to the implications of unanticipated transmission delays or failures of the link. ^a
- Each implementation of an LUF7 Gateway must be individually and thoroughly tested for proper operation before being placed into service.

Failure to follow this instruction can result in death, serious injury, or equipment damage.

^a For additional information, refer to NEMA ICS 1.1 (latest edition), "Safety Guidelines for the Application, Installation, and Maintenance of Solid State Control" and to NEMA ICS 7.1 (latest edition), "Safety Standards for Construction and Guide for Selection, Installation and Operation of Adjustable-Speed Drive Systems".

2.3. Mounting the Gateway on a DIN Rail

Mounting the gateway

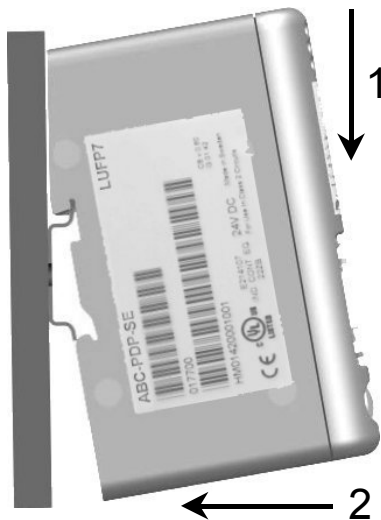

Start by fitting the rear base of the gateway to the upper part of the rail, pushing downwards (1) to compress the gateway's spring. Then push the gateway against the DIN rail (2) until the base of the gateway box fits onto the rail.

Removing the gateway

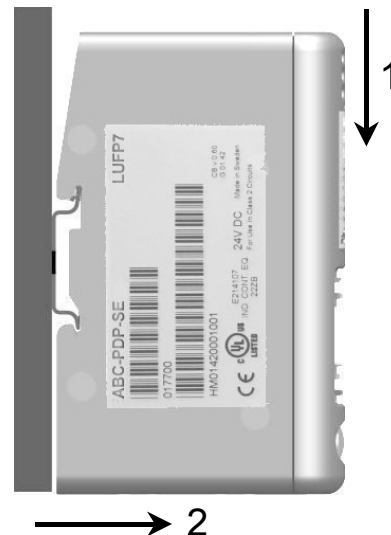

Start by pushing the gateway downwards (1) to compress the gateway's spring. Then pull the bottom of the gateway box forwards (2) until the box comes away from the rail.

NOTE: The spring is also used to ground the gateway (Protective Earth).

2. Hardware Implementation of the LUF7 Gateway

2.4. Powering the Gateway

Profibus-DP / Modbus RTU gateway – View from underneath

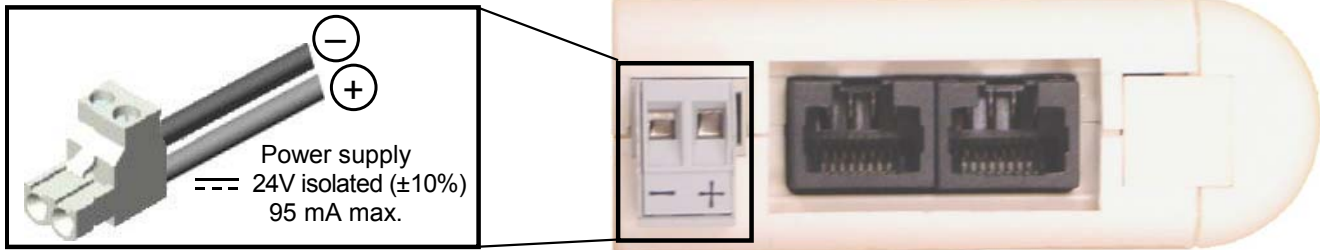

⚠ WARNING

RISK OF UNINTENDED EQUIPMENT OPERATION

Do not use the 24 VDC power available from the Profibus network cabling to operate the LUF7 Gateways, as the negative terminal (—) of this power is not necessarily at the installation earth ground potential. Use of an ungrounded power supply may cause the LUF7 devices to operate in an unexpected manner.

To ensure reliable operation, the LUF7 Gateways require a separate power supply where the negative terminal (—) is connected to the installation earth ground.

Failure to follow this instruction can result in death, serious injury, or equipment damage.

Recommendations:

- Use 60/75 or 75xC copper (CU) wire only.
- The terminal tightening torque must be between 5-7 lbs-in (0.5-0.8 Nm).

2.5. Connecting the Gateway to the Modbus Network

Three typical examples of Modbus connection for the gateway and its slaves are shown below. There are many other possible Modbus connections, but they are not covered in this document.

2. Hardware Implementation of the LUFP7 Gateway

2.5.1. Examples of Modbus Connection

- “Bus” topology with LU9 GC3 splitter box

The connections are shown below:

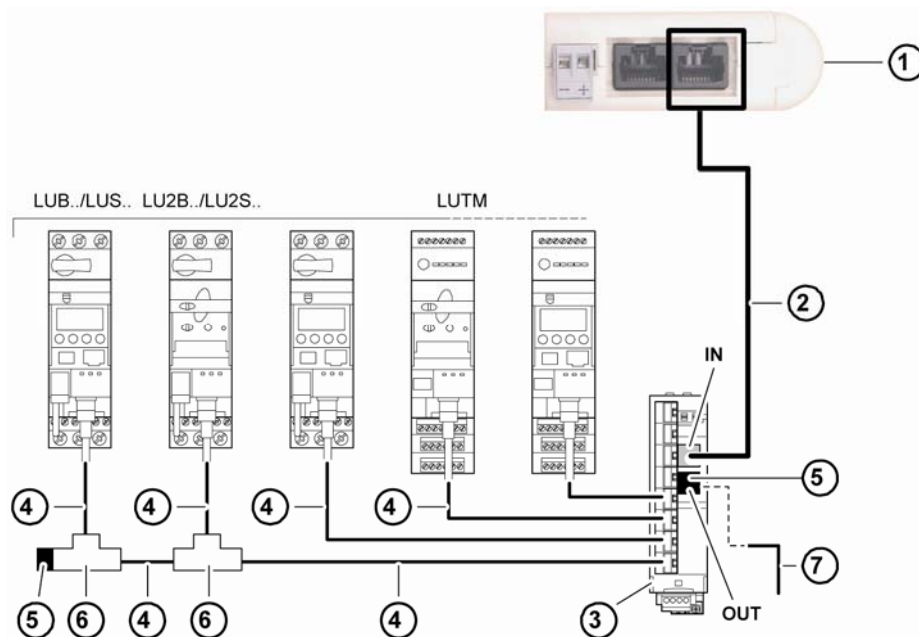

- 1 LUFP7 gateway
- 2 Modbus cable
- 3 Modbus splitter box LU9 GC3
- 4 Modbus cables VW3 A8 306 R••.
- 5 Line terminators VW3 A8 306 R
- 6 Modbus T-junction boxes VW3A8306TF•• (with cable)
- 7 Modbus cable (to another splitter box) TSX CSA•00 (replaces (5))

NOTE: It is advisable to place a line terminator at each end of the bus to avoid malfunctions on the communication bus. This means that a tee should not have a free connector. It is either connected to a slave or to the master, or there is a line terminator.

NOTE: It is important to connect the bus to the “IN” input of the splitter box. Connection to another splitter box is made via the “OUT” output.

2. Hardware Implementation of the LUF7 Gateway

- **“Bus” topology with VW3 A8 306 TF3 T-junction boxes:** This topology uses VW3 A8 306 TF3 T-junction boxes to connect each of the Modbus slaves to the main section of the Modbus network. Each box should be placed in the immediate vicinity of the Modbus slave it is associated with. The cable for the main section of the Modbus network must have male RJ45 connectors (like the VW3 A8 306 R cable used with the splitter box). The lead between the T-junction box and the slave or the Modbus gateway is an integral part of this box. The connections are shown below:

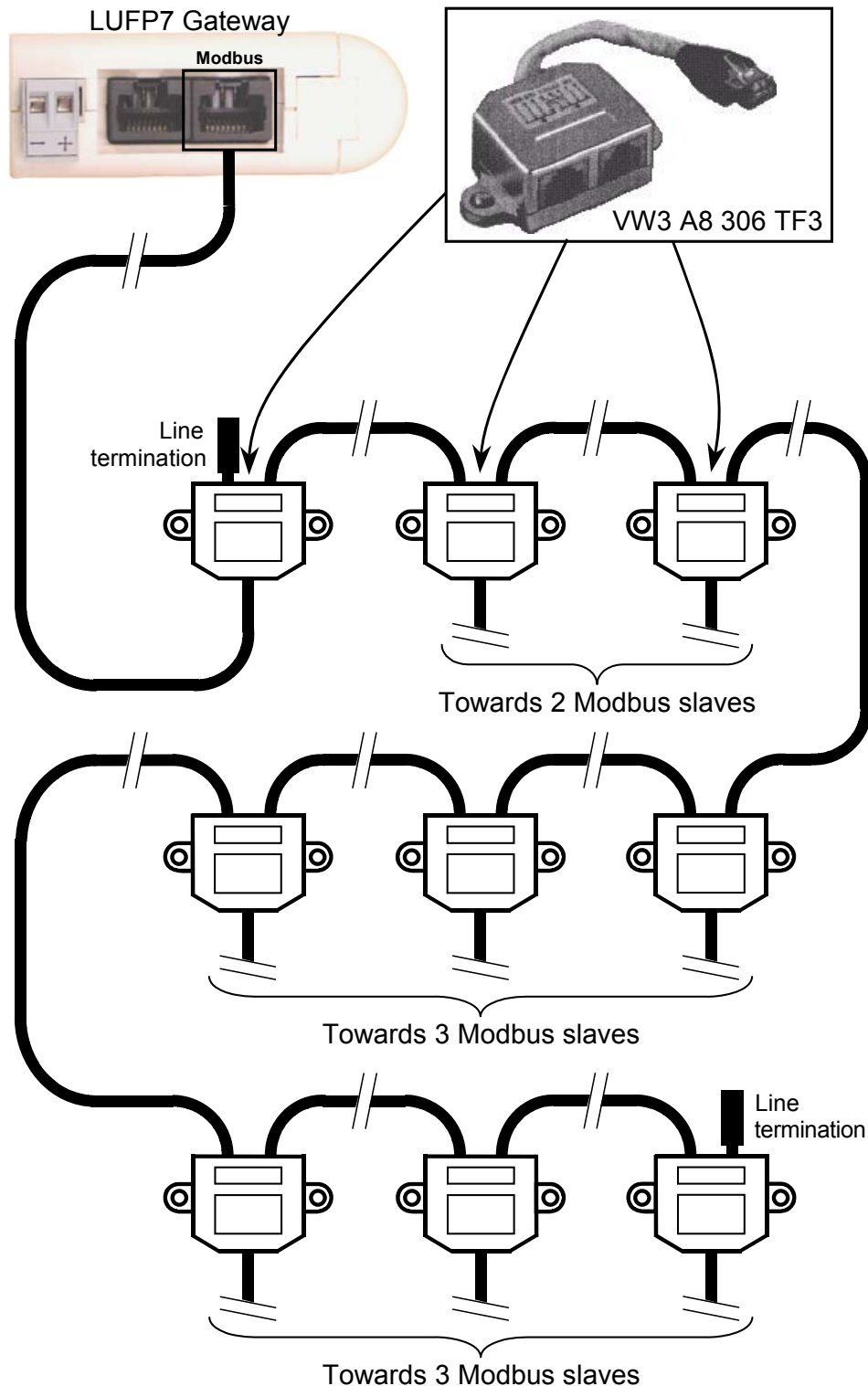

2. Hardware Implementation of the LUF7 Gateway

- **“Bus” topology with SCA junction boxes:** This topology is similar to the previous one, except that it uses TSXSCA62 subscriber connectors and/or TSXCA50 subscriber connectors. We recommend using a VW3 A68 306 connection cable and the TSXCSA•00 Modbus cables. Connect the RJ45 connector on the VW3 A68 306 cable to the Modbus connector on the LUF7 gateway.

The connections are shown below:

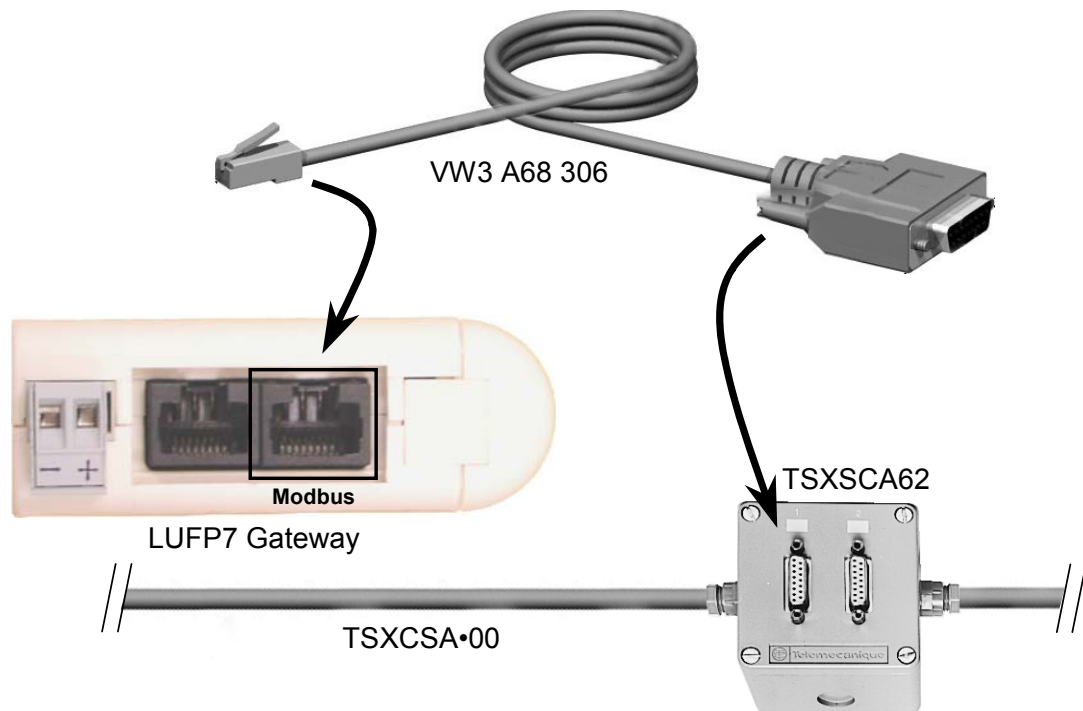

2.5.2. Pin Outs

In addition to the pin out for the connector on the gateway, the one on the VW3 A68 306 cable is also shown below, as it is the only Modbus cable which does not exclusively use RJ45 connections.

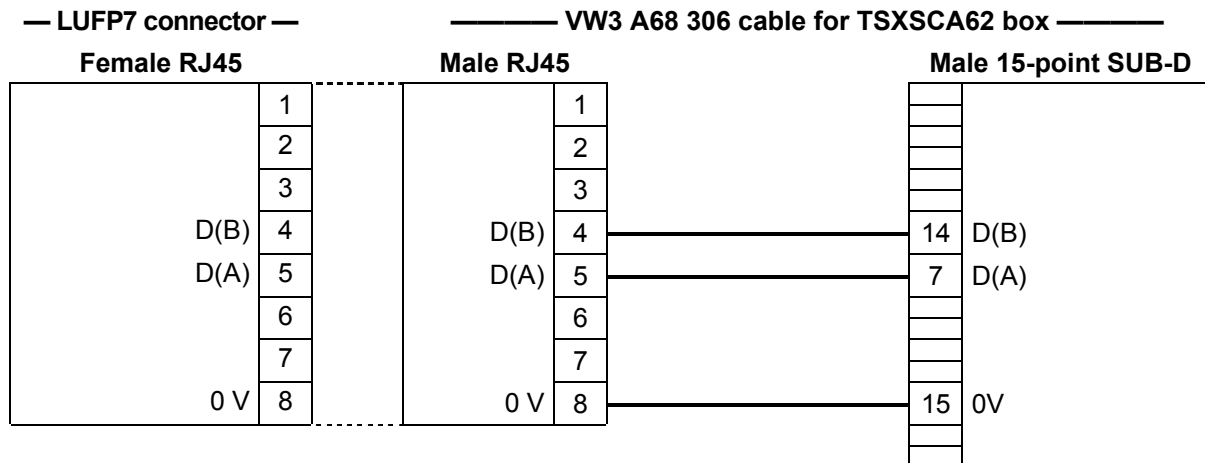

2. Hardware Implementation of the LUF7 Gateway

2.5.3. Wiring Recommendations for the Modbus Network

- Use a shielded cable with 2 pairs of twisted conductors,
- connect the reference potentials to one another,
- maximum length of line: 1,000 meters (3280 ft)
- maximum length of drop line / tap-off: 20 meters (65.5 ft)
- do not connect more than 9 stations to a bus (slaves and one LUF7 gateway),

⚠ WARNING

RISK OF UNINTENDED EQUIPMENT OPERATION

Do not connect more than 9 stations to the Modbus fieldbus (gateway and 8 slaves). While the gateway may appear to operate correctly with more than 9 devices, it is likely one or more devices will only communicate intermittently, leading to unpredictable system behavior.

Failure to follow this instruction can result in death, serious injury, or equipment damage.

- cable routing: keep the bus cable away from power cables (at least 30 cm (0.98 ft)), make crossings at right angles if necessary, and connect the cable shielding to the earth on each unit,
- adapt the line at both ends using a line terminator (see diagram and VW3 A8 306 RC termination below).

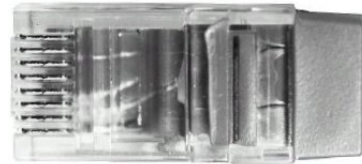
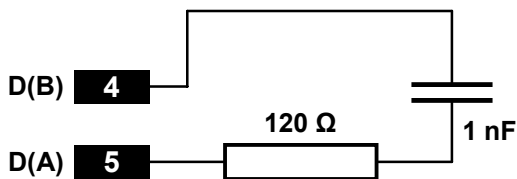

— Line termination recommended at both ends of the line —

— VW3 A8 306 RC line termination —

⚠ WARNING

MODBUS TERMINATION USING THE RESISTANCE-ONLY METHOD

Use only RC (Resistance-Capacitance) Modbus cable terminations with the LUF7 Gateway. The LUF7 gateways are designed to support client equipment that will not function correctly without using RC-type Modbus cable termination.

Failure to follow this instruction can result in death, serious injury, or equipment damage.

2. Hardware Implementation of the LUF7 Gateway

To make it easier to connect the units using the topologies described in chapter 2.5.1, various accessories are available in the *Schneider Electric* catalogue:

1) Hubs, junctions, and line terminations:

- LU9GC03 hub This passive box has 8 female RJ45 connectors. Each of these connectors can be connected to a Modbus slave, to a Modbus master, to another Modbus hub, or to a line termination.
("bus" topology with LU9GC03 splitter boxes)
- VW3 A8 306 TF3 T-junction box This passive box includes a short lead with a male RJ45 connector allowing it to be connected directly to a Modbus slave, without having to use a different cable. It is fitted with 2 female RJ45 connectors for the connection of two Modbus cables of the VW3 A8 306 R•• type.
("bus" topology with VW3 A8 306 TF3 T-junction boxes)
- 2-way TSXSCA62 subscriber connector This passive box has a printed circuit fitted with screw terminals and allows the connection of 2 subscribers to the bus (2 female 15 point SUB-D connectors). It includes the line termination when the connector is located at the end. It is fitted with 2 screw terminals for the connection of two double twisted pair Modbus cables.
("bus" topology with SCA junction boxes)
- TSXCA50 SCA junction box This passive box allows a Modbus unit to be connected to a screw terminal. It includes the line termination when the connector is located at the end. It is fitted with 2 screw terminals for the connection of two double twisted pair Modbus cables.
("bus" topology with SCA junction boxes)
- VW3 A8 306 RC double termination Each of these two red passive boxes is a male RJ45 connector 3 cm (1.18 in) long containing an RC line termination (see diagram and illustration above). Only the abbreviation "RC" is shown on these boxes.
(all topologies)

2) Cables:

- VW3 A8 306 R•• Modbus cable Shielded cable with a male RJ45 connector at each end.
("bus" topology with SCA junction boxes)
- VW3 A68 306 Modbus cable Shielded cable with a male RJ45 connector and a male 15 point SUB-D connector. It is used to connect a Modbus subscriber (slave or master) to a TSXSCA62 or TSXCA50 box.
("bus" topology with SCA junction boxes)
- Shielded double twisted pair Modbus cable Bare cable (without connectors) used to make up the main section of the Modbus network. There are three items available: TSXCSA100 (100 m or 328 ft), TSXCSA200 (200 m or 656 ft), and TSXCSA500 (500 m or 1640 ft).
("bus" topology with branch boxes)

2. Hardware Implementation of the LUF7 Gateway

2.6. Connecting the LUF7 gateway to the Profibus-DP Network

Connect the SUB-D 9-point male plug on the Profibus-DP connector to the Profibus-DP plug on the LUF7 gateway.

Connections are illustrated here:

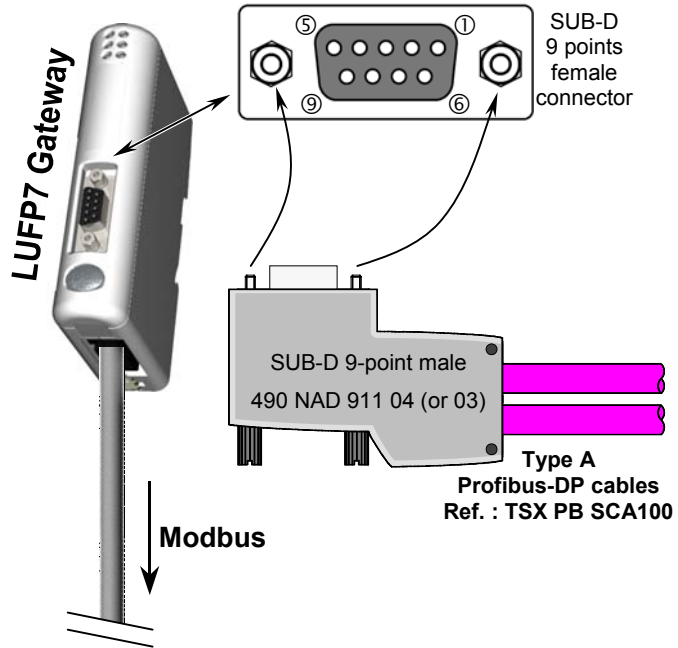

2.6.1. Pin Outs

LUF7 plug 9-point SUB-D female		490 NAD 911 04/03 connector 9-point SUB-D male		Type A cables (TSX PB SCA100)	
	1	1		Incoming A cable	
	2	2			
D(B)	3	3	B-line / RxD/TxD +		
RTS	4	4	Request To Send (1)		
GND	5	5	GND Network (2)		
+5V	6	6	+5V Network (2)		
	7	7			
D(A)	8	8	A-line / RxD/TxD -	Outgoing A cable	
	9	9			
Grounding / Shielding		Shielding / Grounding			

(1) This signal is not mandatory and may be ignored for the LUF7 gateway.

(2) The "GND" and "+5V" pins are meant to supply the line termination if it is present in the connector being used.

2. Hardware Implementation of the LUFP7 Gateway

2.6.2. Wiring Recommendations for the Profibus-DP Network

- Use a shielded cable with a twisted pair of copper conductors, preferably a type A Profibus-DP cable.
- Connect the reference potentials to one another.
- You may choose the transmission rate, within limits, ranging from 9.6 kbit/s to 12 Mbit/s. The choice is made at network startup and applies to all network subscribers.
- The maximum length of the line (segment) is inversely proportional to the transmission rate.

Transmission rate	(bit/s)	9.6 k	19.2 k	93.75 k	187.5 k	500 k	1.5 M	3.6 or 12 M
Distance/segment	(m)	1,200	1,200	1,200	1,000	400	200	100
	(ft)	3,937	3,937	3,937	3,280	1,312	656	328
With 3 repeaters	(m)	4,800	4,800	4,800	4,000	2,000	800	400
	(ft)	15,748	15,748	15,748	13,123	6,562	2,625	1,312

Experience shows that these lengths may be doubled using lines with a section of 0.5 mm² (20 AWG).

- Do not connect more than 32 master or slave stations per segment without a repeater, 127 maximum (repeaters included) with the 3 repeaters; do not use more than 3 repeaters.
- Cable routing: keep the bus cable away from power cables (at least 30 cm (0.98 ft)), make crossings at right angles if necessary and connect the cable shielding to the earth on each unit.
- The network ends on an active line termination, at each segment end (see diagram below); many suppliers have provided their cables with switchable line terminations. The LUFP7 gateway has no internal line termination and therefore applies a 5V voltage between pins 5 and 6 of its Profibus-DP plug in order to allow for the use of an external line termination when the gateway is at the end of the line.

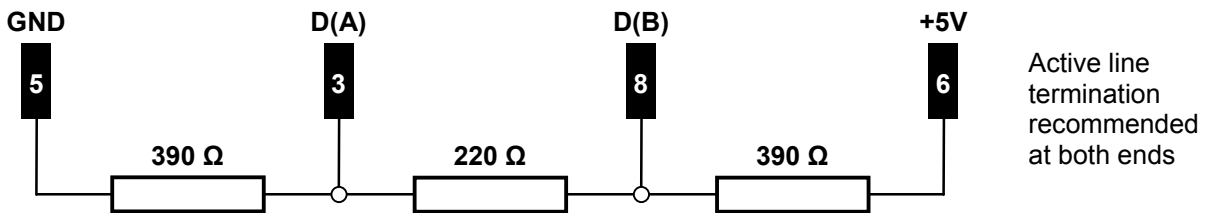

NOTE: If you use a 490 NAD 911 03 connector on each of the two stations located at segment end, you won't have to use an external line termination, since a line termination is integrated to that type of connector. However, if you must disconnect a station to which such a connector is connected, move the connector to another station on the same network so that the line termination continues to be supplied. If you do not wish to make that type of arrangement, preferably use connectors featuring a switchable line termination.

2. Hardware Implementation of the LUF7 Gateway

To connect stations to the Profibus-DP network more easily, several accessories are offered in the *Schneider Electric* catalogue:

- Single twisted pair type A Profibus-DP cable (100 m or long): **TSX PB SCA100**. If you use a different cable, please check that its electric characteristics are as close as possible to those of type A cables (see Appendix A: Technical Characteristics).
- Line connector: **490 NAD 911 04**. The SUB-D 9-point male plug on that connector should not be connected to a station located at the segment end, as the connector has no line termination. This passive box contains a printed circuit fitted with one or two terminal boxes with screws for connecting one incoming Profibus-DP cable and one outgoing Profibus-DP cable.
- End of line connector: **490 NAD 911 03**. The SUB-D 9-point male plug on that connector must be *imperatively* connected to a station located at segment end, since the connector has a line termination. This passive box contains a printed circuit fitted with one terminal box with screws for connecting one incoming Profibus-DP cable.

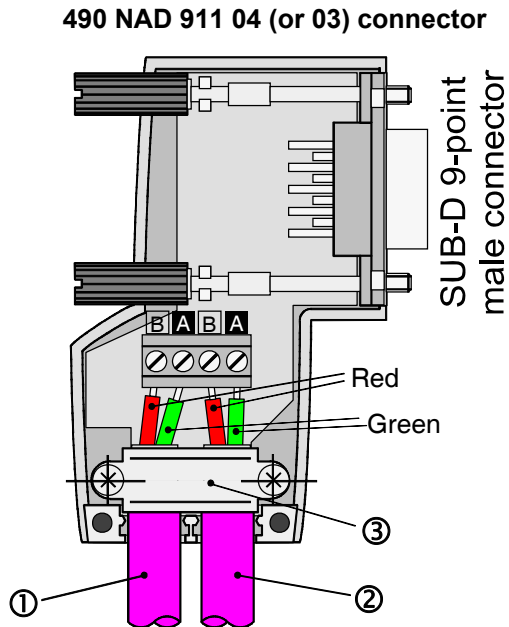

Legend:

- ① Incoming A cable.
- ② Outgoing A cable (absent in the case of the 490 NAD 911 03 connector).
- ③ Cable collar; the cable sheath must be uninsulated, at the most, in the middle of the collar.

2. Hardware Implementation of the LUF7 Gateway

2.7. Configuring the Profibus-DP Communication Features

This configuration must be carried out when the gateway is turned off.

 CAUTION
OPENING LUF7 COVER WITH POWER ON
The power supply of the gateway must be turned off before opening the cover. Once the cover has been removed, make sure you touch neither the electrical circuits nor the electronic components, as this may damage the device.
Failure to follow this instruction can result in injury or equipment damage.

This task is limited to configuring the gateway's Profibus address, as the communication speed on the Profibus network (9.6 kbits/s to 12 Mbits/s) is automatically detected by the gateway.

The two coding wheels used for configuring the gateway's address are hidden behind the gateway cover ⑤ (see illustration in chapter 2.2). To remove this cover, insert the end of a small flat screwdriver between the top of the hood and the gateway box and pull it out.

2.7.1. Encoding the Gateway Address

The LUF7 gateway is identified on the Profibus-DP bus by its address, ranging from 1 to 99.

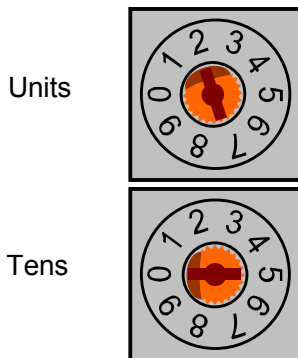

The gateway's Profibus-DP address depends on the position of the two coding wheels represented on the left, in their factory-setting positions (default address = 2).

This address is the sum of the decimal values given by the angular positions of the bottom coding wheel (tens) and the top coding wheel (units).

2. Hardware Implementation of the LUF7 Gateway

Any change to the gateway's address shall be taken into account only once it is powered on again.

Examples:

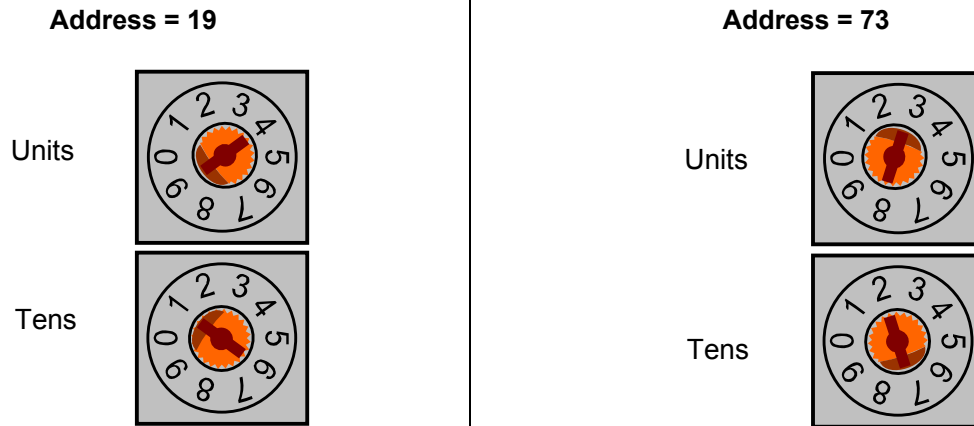

2.7.2. No Internal Line Termination

The LUF7 gateway has no active line termination. You must use a Profibus-DP connector with such a termination if you place the gateway at one of the ends of a bus segment.

3. Signaling

The gateway's 6 LEDs and the descriptive label on the removable cover which hides its two coding wheels (gateway address) allow you to diagnose the status of the gateway:

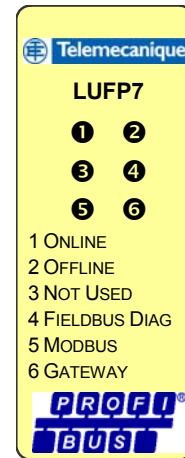
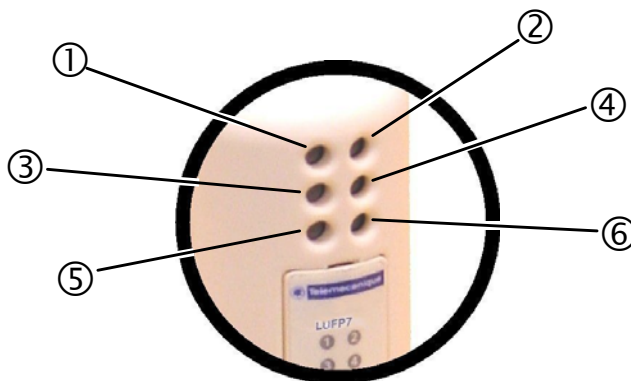

DEL	LED → Gateway state
1 ONLINE	Off: Profibus-DP bus: Gateway off-line Green: Profibus-DP bus: Gateway on-line (exchanges are possible)
3 NOT USED	Off: —
5 MODBUS	Off: No power
	Flashing (green): No Modbus communications
	Green: Modbus communications OK Red: - Loss of communication with at least one Modbus slave (2) - Exception code coming from a command or a transaction

LED	LED → Gateway state
2 OFFLINE	Off: Profibus-DP bus: gateway on-line
	Red: Profibus-DP bus: Gateway off-line (exchanges are impossible)
4 FIELD BUS DIAG	Off: Gateway initialization achieved
	Flashing red (1 or 2 Hz): Gateway configuration error. (1)
	Flashing red (4 Hz): Error when resetting the gateway on Profibus-DP. (1)
6 GATEWAY	Off: No power
	Flashing (red/green): Configuration absent / not valid ↳ Use ABC-LUF7 Config Tool to load a valid configuration
	Green: Gateway currently being initialized and configured
	Flashing (green): Gateway is in running order: Configuration OK

- (1) Specific errors indicated by the LED **4** FIELD BUS DIAG
- Flashing red LED (1 Hz): input and/or output data length is invalid.
↳ Check the overall length of the gateway data, under ABC-LUF7 Config Tool (“Monitor” option from the “Sub-Network” menu), then adjust exchanges with the gateway accordingly, using the Profibus-DP network configuration software (e.g.: SyCon).
 - Flashing red LED (2 Hz): User parameter data length and/or content is invalid.
 - Flashing red LED (4 Hz): Error when resetting the ASIC in charge of Profibus-DP communications.
- (2) The LED **5** MODBUS becomes red when one or more Modbus slaves fail to respond to the gateway in the expected fashion. This can be caused by:
- Loss of communications (e.g. a broken or disconnected cable)
 - Writing incorrect values to the outputs corresponding to the two aperiodic read/write services (see chapter 4.3).

3. Signaling

NOTE: When LED ⑤ MODBUS is flashing red due to a simple loss of communications, the LED will revert to a green state when communications are restored. When LED (5) is flashing red due to the use of incorrect values with the aperiodic read/write services, then the only way to clear the error is to reuse these aperiodic services with correct values.

NOTE: If the LED ⑥ GATEWAY is flashing following a sequence beginning with one or more red flashes, we advise that you note down the order of this sequence and give this information to the Schneider Electric support service. In some cases, power the gateway off then back on again to solve the problem.

4. Software Implementation of the Gateway

4.1. Introduction

This chapter gives an introduction to a quick implementation of the LUF7 gateway, using its default configuration. All LUF7 gateways ship pre-configured.

NOTE: The configuration has been defined for 8 motor starters. If you use less than 8, refer to chapter 6.

This pre-configuration means that the user does not have to configure the LUF7 gateway using ABC-LUF7 Config Tool. This configuration is described in order to allow the gateway to be used with a configuration tool for Profibus-DP master PLCs. As an example this implementation will use Sycon (version \geq V2.5.0.0), the multi-network configuration software marketed by *Hilscher* (Réf.: TLX L FBC 10 M), PL7 PRO (version \geq V3.0) and a Telemecanique PLC from the Premium range (e.g. TSX 57353 v5.1) to which the appropriate Profibus-DP communication board shall be added (TSX PBY 100 coupler).

4.1.1. System Architecture

The default configuration for an LUF7 gateway allows it to control, monitor and configure 8 TeSys U motor starters:

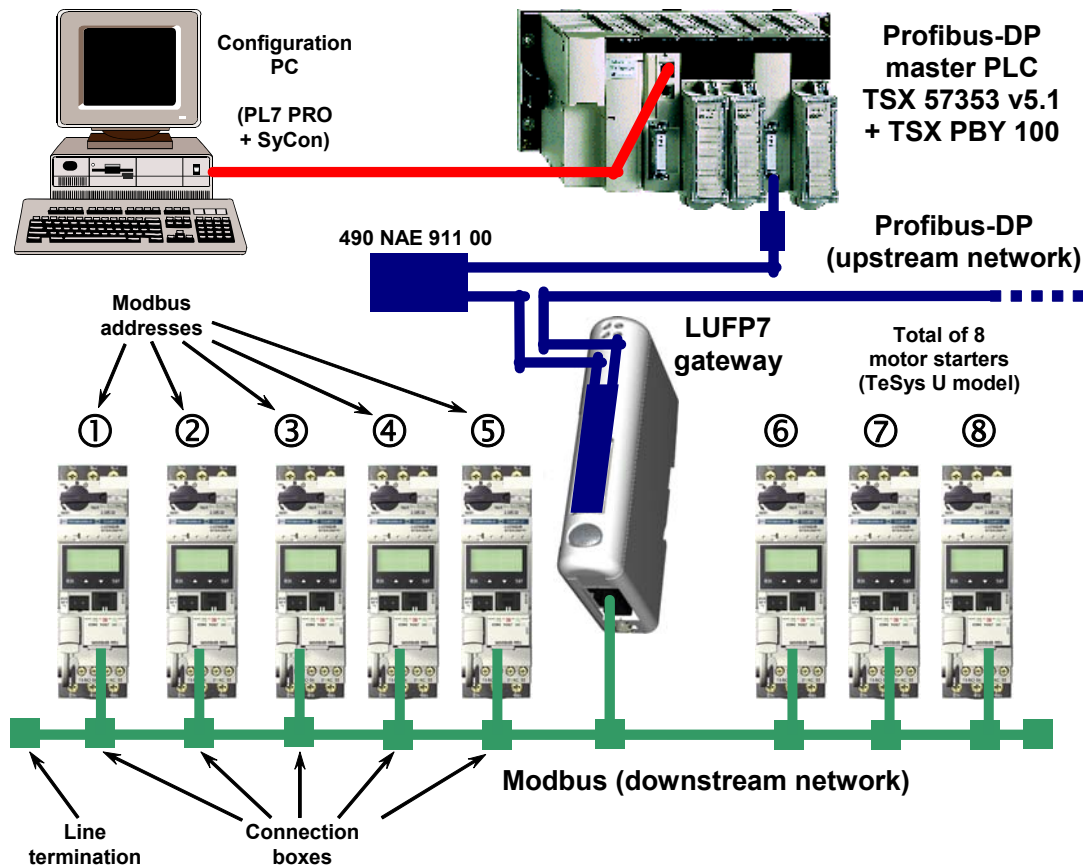

Please see chapter 2, for the hardware implementation of the default configuration.

4. Software Implementation of the Gateway

4.1.2. Configuring the Motor Starters

Each motor starter should be configured as follows:

Protocol:	Modbus RTU slave	Start bits	1
Modbus address	1 to 8	Parity	None
Bitrate	19,200 bits/s	Parity bit	0
Data bits	8	Stop bits	1

When using a TeSys U motor starter with a Modbus communication module (LULC03● module), the configuration parameters for the RS485 connection are automatically detected, only the Modbus address of the motor starter needs to be configured.

4.1.3. Modbus Cycle Time

The LUF7 gateway's default configuration sets a cycle time of 300 ms on Modbus commands for each of the 8 TeSys U motor starters.

4.1.4. Managing Degraded Modes With the Gateway Default Configuration

The default management for degraded modes is described below. Please see chapter 6.12.2.1, if you would like to change the way that degraded modes are managed within the gateway.

4.1.4.1. Description of the Gateway Degraded Mode Options

Offline options for fieldbus

This option affects the data sent to a Modbus slave if there is no communication coming from the Profibus master.

It is defined at the Query level of each command or transaction sent to the different slaves.

This option can take 3 values:

- Clear: All data sent to the concerned Modbus slave is set to 0.
- Freeze: All data sent retains its current value.
- No scanning: The query is no more transmitted.

With the gateway's default configuration:

- "Clear" option is selected for periodic exchanges
- "No scanning" is selected for aperiodic exchanges

Which means that Command and Status registers of the TeSys U continue to be refreshed:
but output memory associated (Tesys U command registers) is forced to 0,
and input memory (Tesys U status registers) works normally,
Aperiodic Modbus exchanges are stopped.

Timeout time

This option defines the time the gateway will wait for a response before it either retries to send the same request, or it disconnects the slave and declares it missing.

It is defined at the Query level of each command or transaction sent to the different slaves.

With the gateway's default configuration, this time is equal to 300 ms.

4. Software Implementation of the Gateway

Retries

This option determines the number of re-transmissions carried out by the gateway if there is no response from the slave.

It is defined at the Query level of each command or transaction sent to the different slaves.

With the gateway's default configuration, this option is set to 3.

Reconnect time

This option defines the amount of time the gateway will wait before it tries to communicate again with a Modbus slave that was previously declared as missing.

It is defined at the Query level of each command or transaction sent to the different slaves.

With the gateway's default configuration, this time is equal to 10 sec.

WARNING

RISK OF UNINTENDED EQUIPMENT OPERATION

During the reconnect time, you cannot control a slave (read/write) via the bus. Depending on the slave characteristics and the watchdog configuration, the slave can keep the same status or take a fallback position.

To avoid an unintended equipment operation, you must know the possible status of a slave and adapt the timeout and reconnect time values according to the request sending rate.

Failure to follow this instruction can result in death, serious injury, or equipment damage.

Offline options for sub-network

This option affects the data sent to the Profibus master if there is no response coming from a slave.

It is defined at the Response level of each command or transaction sent from the different slaves.

This option can take 2 values:

Clear: All data sent to the Profibus master is set to 0.

Freeze: All data sent to the Profibus master retains its current value.

With the gateway's default configuration, "Clear" option is selected and Tesys U status registers and aperiodic input data are forced to 0.

4.1.4.2. Degraded Mode Description

This description takes into account the following elements:

The PLC processor

The Profibus master

The LUFP7 gateway

The Tesys U starters-controllers.

4. Software Implementation of the Gateway

PLC processor stopped or on failure

PLC processor response
Outputs: Software error: outputs reset to default state or hold their present state depending on configuration. Hardware error: (EEPROM or hardware failure), output state will be undetermined.
Inputs: PLC stops responding to inputs in any error state.
Profibus master response
Depending on master configuration: the master stops to communicate with the LUF7 gateway, or forces Profibus outputs to 0, and refresh inputs, or holds Profibus outputs in their last position, and refreshes inputs.
LUF7 gateway response
If the master forces Profibus outputs to 0, and refreshes the inputs: periodic: Modbus exchanges continue to run with outputs set to 0, input memory continues to be refreshed, aperiodic: Modbus exchanges are stopped.
If the master holds Profibus outputs, and refreshes the inputs: periodic: Modbus exchanges continue to run, with output memory associated hold in their last position, input memory continues to be refreshed, aperiodic: Modbus exchanges are stopped.
Tesys U response
If the master forces the outputs to 0: periodic Modbus exchanges continue to run, Command registers are set to 0 and motors are stopped, Status register are transmitted to the gateway, aperiodic Modbus exchanges are stopped.
If the master holds Profibus output words, and refreshes the inputs words: Periodic: Modbus exchanges continues to run, Command registers hold their last values and motors stays in the same state, Status register data is transmitted to the gateway, Aperiodic: Modbus exchanges are stopped.

4. Software Implementation of the Gateway

Profibus master stopped or on failure

PLC processor response
The PLC processor provides some error and/or diagnostic objects to the application in case of Profibus master stop or failure (input/output not valid). Refer to the PLC user manual to have their description. This information must be managed in the PLC application.
Profibus master response
If the Profibus master is stopped (command coming from the application): the master stops to communicate with the LUF7 gateway.
If the Profibus master is on failure, the master stops to communicate with the processor and the LUF7 gateway.
LUF7 gateway response
With the gateway default configuration (Offline option for fieldbus): periodic: Modbus exchanges continue to run, with the output memory associated forced to 0, input memory continues to be refreshed, aperiodic: Modbus exchanges are stopped.
Tesys U response
Periodic: Modbus exchanges continue to run: Command registers are set to 0 and motors are stopped, Status register data is transmitted to the gateway, Aperiodic: Modbus exchanges are stopped.

LUF7 gateways disconnected on Profibus side

PLC processor response
The PLC processor provides some error and diagnostic objects coming from the Profibus master in case of slave disconnection from the application: Refer to the PLC user manual to have their description. This information must be managed in the PLC application.
Profibus master response
The Profibus master provides the processor with some error and diagnostic objects in case of Profibus slave disconnection.
LUF7 gateway response
With the gateway default configuration (Offline option for fieldbus): periodic: Modbus exchanges continue to run, with output memory associated forced to 0, input memory continues to be refreshed, aperiodic: Modbus exchanges are stopped.
Tesys U response
periodic: Modbus exchanges continue to run: Command registers are set to 0 and motors are stopped, Status register data is transmitted to the gateway, aperiodic: Modbus exchanges are stopped.

4. Software Implementation of the Gateway

LUF7 gateways failure

PLC processor response
The PLC processor provides some error and diagnostic objects coming from the Profibus master in case of slave failure to the application. Refer to the PLC user manual to have their description. This information must be managed in the PLC application
Profibus master response
The Profibus master provides the processor with some error and diagnostic objects in case of Profibus slave failure.
LUF7 gateway response
In case of a failure, the gateway stops to communicate with the Profibus master and the Modbus slaves.
Tesys U response
Depending on the Tesys U configuration: If the starters-controllers do not receive any requests, they will: stop the motor, keep the same state, or run the motor. Refer to the Tesys U user manuals to adjust these fallback positions.

LUF7 gateways disconnected on Modbus side or Tesys U failure

PLC processor response
The processor gives access to the gateway status word coming from the Profibus master input table and to the gateway command word coming from the output table. These 2 words must be managed in the PLC application in order to detect if a Modbus slave is missing.
Profibus master response
The Profibus master must be configured to access the gateway status and command words in order to provide Modbus diagnostic information.
LUF7 gateway response
With the gateway's default configuration: Timeout time = 300 ms, Retries = 3, Reconnect time = 10 sec, and Offline option for sub-network = Clear. After sending a request to a slave, if there is no response after 300 ms, the gateway will send it again three times before giving the information about the slave missing in the gateway status word. Data sent to the Profibus master (Read requests) is set to 0. The gateway will try to reconnect the slave missing with the same sequence every 10 seconds.
Tesys U response
If the LUF7 gateway is disconnected on Modbus side: The starters-controllers do not receive any requests, depending on their configuration, they will: stop the motor, keep the same state, or run the motor. Refer to the Tesys U user manuals to adjust the fallback position.
In case of a Tesys U failure: No response is sent to the gateway, the motor state will be undetermined. This case must be managed in the PLC application.

4. Software Implementation of the Gateway

4.2. Gateway Configuration under PL7 PRO and SyCon

The Profibus-DP master must be configured so that it has access to all of the data described in Appendix C: Default Configuration, Input and Output data Memory.

The following chapters describe the steps in PL7 PRO (version \geq V3.0) and SyCon (version \geq V2.5.0.0) which you will need to go through so that the gateway is correctly recognised by the Profibus-DP master PLC.

NOTE: The Profibus-DP network which is described in the following chapters only includes one master (TSX 57353 v5.1 + TSX PBY 100) and one slave (LUFP7 gateway). So you will need to adapt the addressing of the inputs and outputs shown below (%IW and %QW) according to any other slaves on the Profibus-DP network which you need to configure.

4.2.1. Setting Up the Hardware Configuration under PL7 PRO

Under PL7 PRO, create a new application or open an application for which you want to add a Profibus-DP network.

Edit the hardware configuration of this application, add a PBY 100 board and then edit its configuration by double-clicking on its location in the rack.

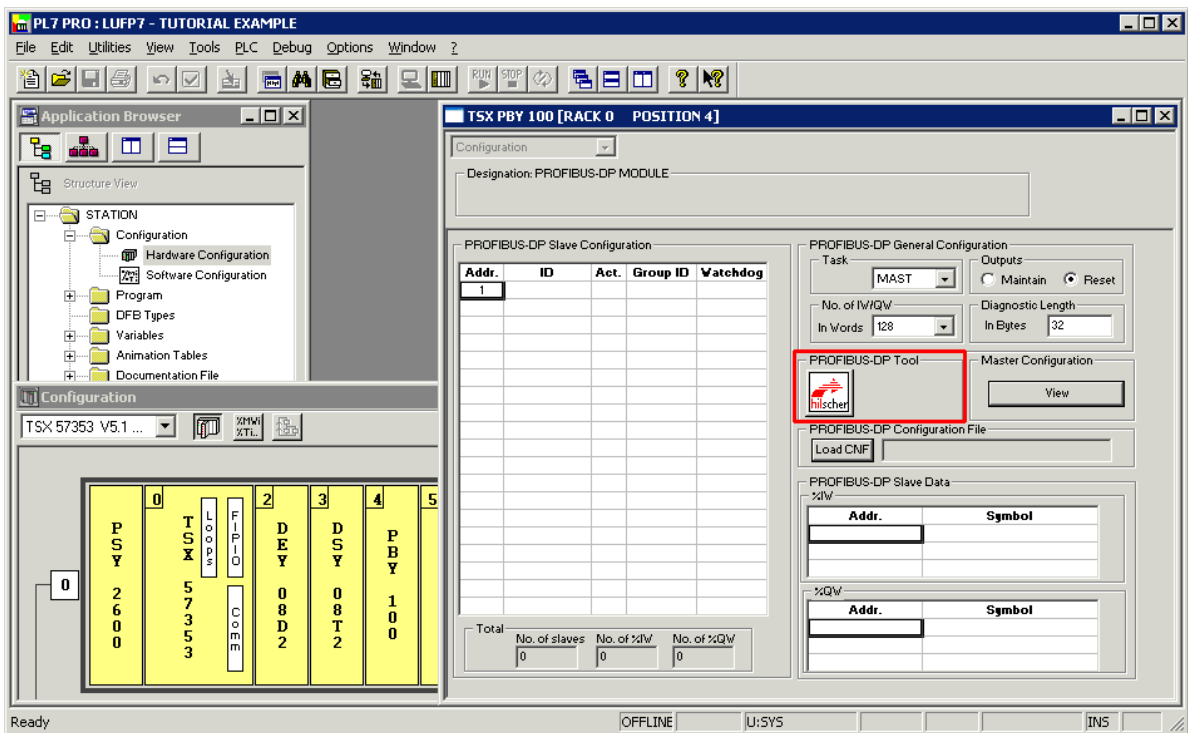

Click on the “hilscher” button (enclosed in a red box above) to start the SyCon configuration tool.

NOTE: This button is not displayed if you have not installed SyCon on your PC.

4. Software Implementation of the Gateway

4.2.2. Creating a Profibus-DP Network under SyCon



Select the “New” option from the “File” menu to create a new configuration, then select the “Profibus” network.

This option creates an empty network segment in the SyCon main window.

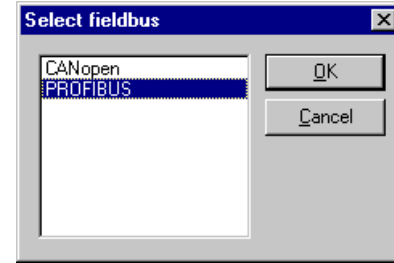
In this guide, we shall immediately save this configuration and name it “LUF7 - Tutorial Example.pb”.



4.2.3. Selecting and Adding the Profibus-DP Master Station

Select the “Master...” option from the “Insert” menu (or click on the  button). Move the mouse pointer (which now looks like a ) to the position where you want to add the Profibus-DP master, and left-click.

Select the “TSX PBY 100” master, then click “Add >>”. If required, edit its address and name.

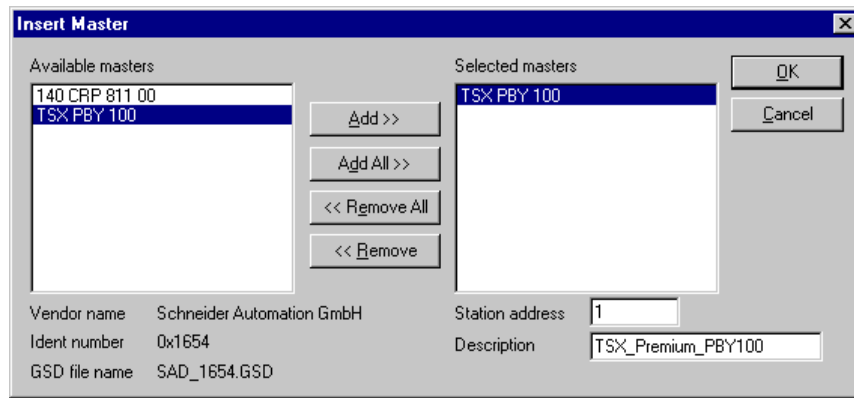

Once back to the SyCon main window, the selected master appears in the selected insertion position:

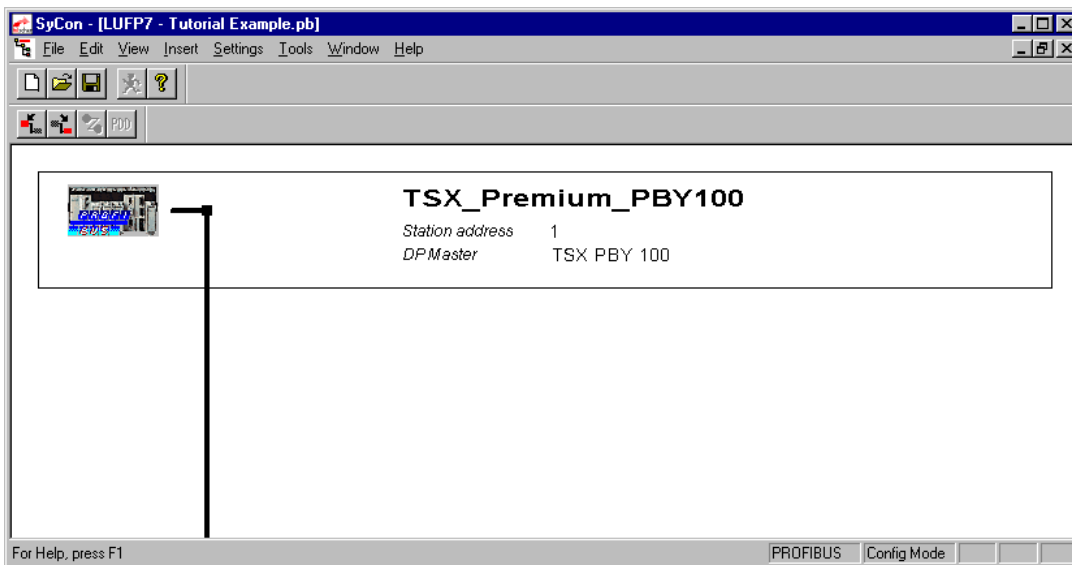

4. Software Implementation of the Gateway

Double-click on the line that corresponds to the Profibus-DP master to open the “Master Configuration” window.

In the “DP Support” frame, verify that the “Auto addressing” box has been checked.

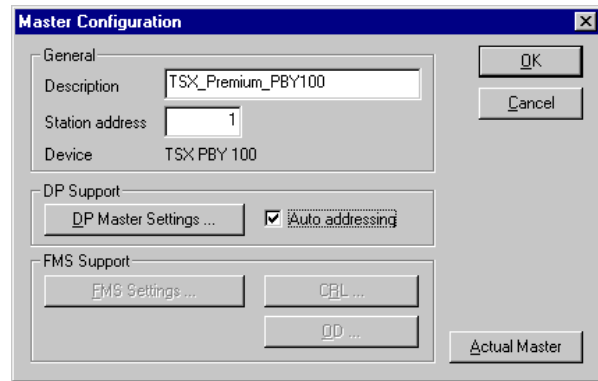
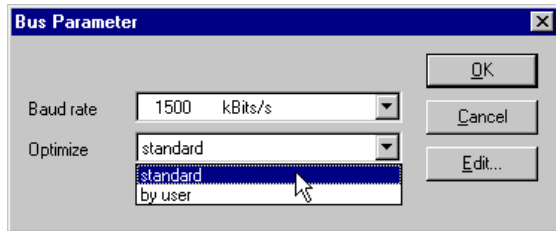
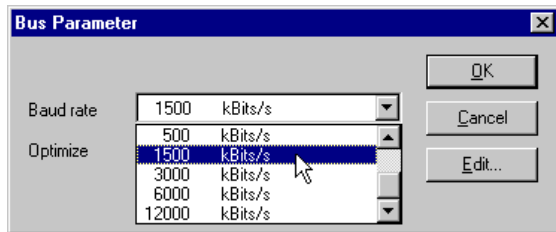

Lastly, select the Profibus-DP master and run the “Bus Parameter...” option from the “Settings” menu to configure the Profibus-DP network baud rate.

NOTE: The “Optimize” option must remain equal to “standard”, except in case of knowledgeable users who want to edit critical Profibus DP network settings (accessible via the “Edit...” button).

4.2.4. Setting up the Gateway Description Files

The GSD file that describes the gateway must be located on the PC hard drive so that SyCon can access it any time. Preferably place the file inside the directory that contains all the GSD files used by SyCon. The description and content of that GSD file are both in Appendix B: LUFP7 Gateway GSD File.

This file can be found on the CD LU9CD1: “Tele071F.gsd”.

- ➔ To import that file under SyCon, run the “Copy GSD” option from the “File” menu and select the GSD file mentioned above from the CD. If the command completes successfully, the following message is displayed: “The import of the GSD file was successful.”

Then, install the symbols representing the gateway under SyCon. The corresponding files are on the <http://www.telemecanique.com> website: “LUFP7_S.DIB”, “LUFP7_R.DIB”, and “LUFP7_D.DIB”.



- ➔ Copy these files into “C:\Program Files\Hilscher\SyCon\Fieldbus\PROFIBUS\BMP”, if this is the path where you have installed SyCon on your PC. All these operations should be conducted using Windows Explorer, for example, as SyCon cannot proceed to their installation.

The symbols that represent each of these three files are given below:



4. Software Implementation of the Gateway

4.2.5. Selecting and Adding the Gateway to the Profibus-DP Network

Run the “Slave...” option from the “Insert” menu (or click on the  button). Move the mouse pointer (which now looks like a ) to the position where you want to add the LUFF7 gateway, then left-click.

In the window that appears, select the “LUFF7” slave, then click the “Add >>” button. If need be, edit its address and name. Gateway address configuration is detailed in chapter 2.7.1.

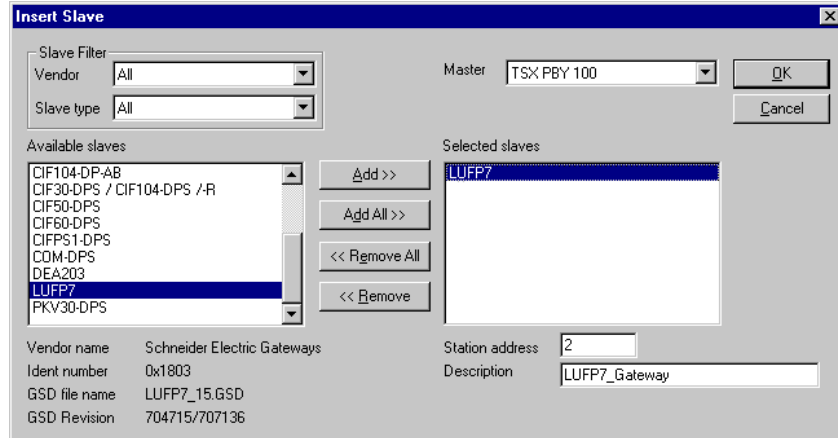

Once back to the SyCon main window, the selected slave appears in the selected insertion position:

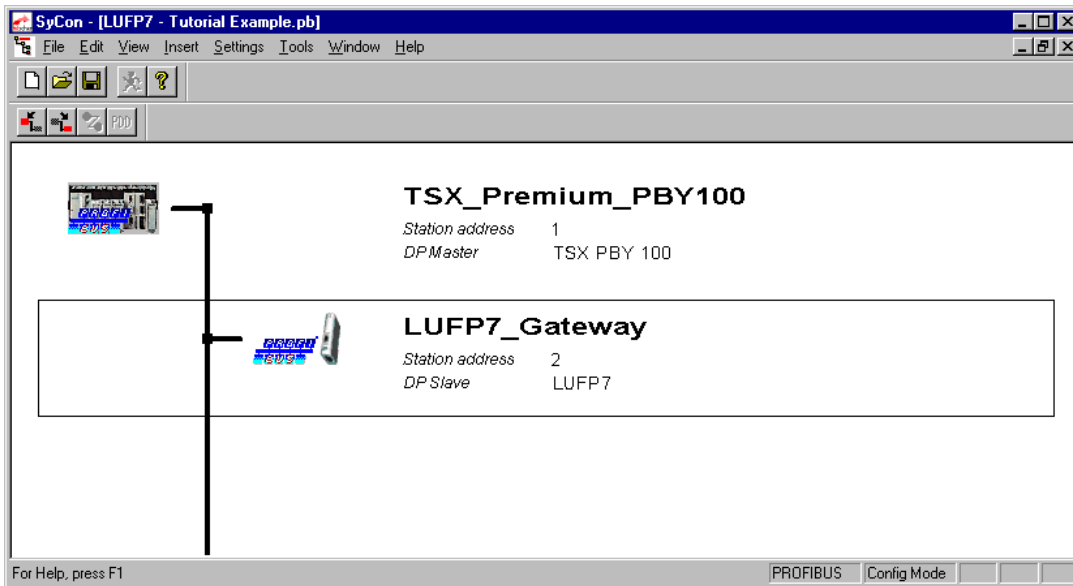

4.2.6. Editing and Configuring the Gateway

Double-click on the line that corresponds to the LUFF7 gateway. The "Slave Configuration" window appears. Conduct the following operations:

- In the list of available modules, select the module called “IN/OUT: 32 Byte (16 word)”. Click the “Append Module” button to add it to the list of modules configured for the gateway. This module occupies one “Slot” and consists of a 16-word I/O module (both in IW and OW). It is intended to allow the exchange of the various data presented in Appendix C: Input and Output Data Memory Area paragraphs.

4. Software Implementation of the Gateway

- In the "Assigned master" frame, check that the Profibus-DP master previously configured is selected. If not, select it.

NOTE: Only the "Assigned master" can control the DP slave to which it has been allocated during the configuration phase. Other DPM1 masters can only read its I/O values.

- In the "General" frame, verify that the two boxes "Activate device in actual configuration" and "Enable watchdog control" are both checked. If not, check both.
- Validate the operations conducted by clicking on "OK".

The left-hand portion of this area specifies the gateway's maximum capacity, and the right-hand portion lists the currently configured "Modules".

Max. length of in-/output data	416 Byte	Length of in-/output data	64 Byte
Max. length of input data	244 Byte	Length of input data	32 Byte
Max. length of output data	244 Byte	Length of output data	32 Byte
Max. number of modules	24	Number of modules	1

Module	Inputs	Outputs	In/Out	Identifier
IN/OUT: 6 Byte (3 word)			3 Word	0x72
IN/OUT: 8 Byte (4 word)			4 Word	0x73
IN/OUT: 10 Byte (5 word)			5 Word	0x74
IN/OUT: 12 Byte (6 word)			6 Word	0x75
IN/OUT: 14 Byte (7 word)			7 Word	0x76
IN/OUT: 16 Byte (8 word)			8 Word	0x77
IN/OUT: 32 Byte (16 word)			16 Word	0x7F

Slot	Idx	Module	Symbol	Type	I Adr.	I Len.	Type	O Addr.	O Len.
1	1	IN/OUT: 32 Byte (16 word)	Module1	I/w	0	16	0/w	0	16

NOTE: Do not use the "Symbolic Names" option to name the I/O exchanged with the gateway. This operation is useless because the symbols you shall define under SyCon would not be exported and retrieved under PL7 PRO.

NOTE: If the "Length of input data" or the "Length of output data" configured for the gateway (under SyCon) differs from the total size of the gateway input memory area or the total size of the gateway output memory area (under ABC-LUFF Config Tool), the gateway shall refuse going on line (LED ❶ off and LED ❷ red) and the configuration error shall be indicated (LED ❹ flashing red, at 1 Hz). Please see chapter 3.

4. Software Implementation of the Gateway

4.2.7. Saving and Exporting the Profibus-DP Network Configuration

Save the configuration by giving it a name (“Save” or “Save As...” option from the “File” menu). The configuration of the Profibus-DP network is then saved in a “.pb” file.

In order to export this configuration for PL7 PRO, follow these steps:

- Select the line that corresponds to the Profibus-DP master (TSX PBY 100).
- Run the “Export ► ASCII” option from the “File” menu. The newly-created file bears the “.cnf” extension.

NOTE: the filename must include a name limited to 8 characters and a 3 character extension (here, “cnf”).

- Once these operations are completed, quit SyCon.

4.2.8. Importing the Configuration of the Profibus-DP Network under PL7 PRO

Under PL7 PRO (see chapter 4.2.1), click on the “Load CNF” button. Using the options in the window that appears, select the “.cnf” file that was saved beforehand (see previous chapter).

Once this import is completed, the full path to this file appears on the right of the “Load CNF” button and the “PROFIBUS-DP slave configuration” frame displays the two configured stations, i.e. “TSX PBY 100”, at the address 1, and “LUF7”, at the address 2.

In the case of the LUF7 gateway, the default values allocated to the configuration options of the “General PROFIBUS-DP configuration” frame can be kept (see table below). Edit them accordingly if you configure other slaves on the same Profibus-DP network.

Optional	Default value	Possible values
Task	MAST	MAST or FAST
Used to select the type of system task that will steer the Profibus-DP network.		
Outputs	Reset	Hold or Reset
Determines whether the %QW outputs meant for the Profibus-DP slaves are held or reset to zero when the associated task (see above) is stopped, as this stop does not cause the TSX PBY 100 board to stop.		
IW/QW number	128 words	32, 64, 128 or 242 words
Determines the number of words used for the input of the TSX PBY 100 board, as well as for its outputs. The “Total” frame indicates the total number of inputs and outputs, all slaves included. The value allocated to the “IW/QW number” option should be greater than, or equal to, the greatest of these two numbers. The LUF7 gateway only requires 16 words (whether for inputs or for outputs). Therefore, we could use a size of 32 words. However, it is preferable to keep the default value, should other slaves be configured.		
Diagnostic length	32 bytes	6 to 244 bytes
Determines the maximum length of a diagnostic on the Profibus-DP network. NOTE: This length should be sufficient to host the longest diagnostic for all the slaves on the network. If the length is insufficient, the slaves concerned shall not be active on the bus because their diagnostic shall be invalid. The “diagnostic length” is equal to 6 bytes in the case of the LUF7 gateway.		

4. Software Implementation of the Gateway

4.2.9. Configuring the Gateway I/O under PL7 PRO

Using the information located in the selected ".cnf" file, PL7 PRO establishes a direct relation between the data for each Profibus-DP slave and its equivalent I/O.

To view the LUFF7 gateway I/O, click on the line of the address 2 station in the "PROFIBUS-DP slave configuration" frame.

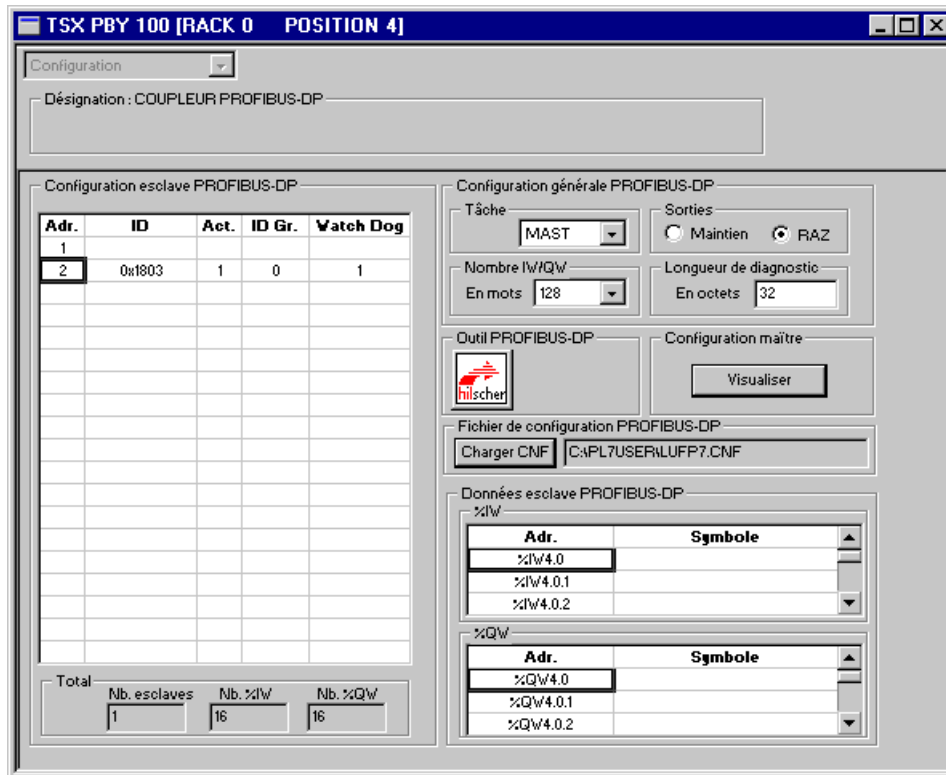

If you use the vertical sliders in the "PROFIBUS-DP slave data" frame, you can see that the gateway's 16 input words have been allocated to inputs %IW4.0 to %IW4.0.15 and that its 16 outputs words have been allocated to outputs %QW4.0 to %QW4.0.15.

4. Software Implementation of the Gateway

The correspondence between the content of the gateway's input memory (see Appendix C: Input Data Memory paragraph) and the PLC inputs “%IW4.0” to “%IW4.0.15” is given in the following table:



Service	PLC input	Description			
		Bit 15.....	Bit 8	Bit 7.....	Bit 0
Managing the downstream Modbus network	%IW4.0	Gateway status word			
Periodic communications — Monitoring of TeSys U motor starters	%IW4.0.1	Value of the motor starter ① status register			
	%IW4.0.2	Value of the motor starter ② status register			
	%IW4.0.3	Value of the motor starter ③ status register			
	%IW4.0.4	Value of the motor starter ④ status register			
	%IW4.0.5	Value of the motor starter ⑤ status register			
	%IW4.0.6	Value of the motor starter ⑥ status register			
	%IW4.0.7	Value of the motor starter ⑦ status register			
	%IW4.0.8	Value of the motor starter ⑧ status register			
Aperiodic communications Reading the value of a motor starter parameter (RESPONSE)	%IW4.0.9	Free memory location	Slave no. (0x01-0x08)		
	%IW4.0.10	Function No. (0x03)	Bytes read (0x02)		
	%IW4.0.11	Value of the parameter read (0xxxxx)			
Aperiodic communications Writing the value of a motor starter parameter (RESPONSE)	%IW4.0.12	Slave No. (0x01-0x08)	Function No. (0x06)		
	%IW4.0.13	Address of the parameter written (0xxxxx)			
	%IW4.0.14	Value of the parameter written (0xxxxx)			
Aperiodic communications (“Trigger bytes” for the responses)	%IW4.0.15	Read parameter response counter	Write parameter response counter		

The correspondence between the content of the gateway output storage (see Appendix C: Output Data Memory paragraph) and the outputs of the “%QW4.0” to “%QW4.0.15” automatic controls is as follows:

Service	PLC output	Description			
		Bit 15.....	Bit 8	Bit 7.....	Bit 0
Managing the downstream Modbus network	%QW4.0	Profibus-DP master command word			
Periodic communications — Controlling TeSys U motor starters	%QW4.0.1	Value of the motor starter ① command register			
	%QW4.0.2	Value of the motor starter ② command register			
	%QW4.0.3	Value of the motor starter ③ command register			
	%QW4.0.4	Value of the motor starter ④ command register			
	%QW4.0.5	Value of the motor starter ⑤ command register			
	%QW4.0.6	Value of the motor starter ⑥ command register			
	%QW4.0.7	Value of the motor starter ⑦ command register			
	%QW4.0.8	Value of the motor starter ⑧ command register			
Aperiodic communications Reading the value of a motor starter parameter (QUERY)	%QW4.0.9	Slave No. (0x01-0x08)	Function No. (0x03)		
	%QW4.0.10	Address of the parameter to be read (0xxxxx)			
	%QW4.0.11	Number of parameters to be read (0x0001)			
Aperiodic communications — Writing the value of a motor starter parameter (QUERY)	%QW4.0.12	Slave number (0x01-0x08)	Function number (0x06)		
	%QW4.0.13	Address of the parameter to be written (0xxxxx)			
	%QW4.0.14	Value of the parameter to be written (0xxxxx)			
Aperiodic communications (“Trigger bytes” for the queries)	%QW4.0.15	Read parameter query counter	Write parameter query counter		

4. Software Implementation of the Gateway

4.2.10. Validating and Saving the Configuration of the TSX PBY 100 Coupler

- ➔ Validate the various operations conducted under PL7 PRO using the  button.
- ➔ Close the configuration window of the TSX PBY 100 coupler.
- ➔ In the PLC's hardware configuration window, click on the  button again.
- ➔ Save the PL7 PRO application by giving it a name.

4.2.11. Allocating Symbols to the Gateway Inputs and Outputs

Allocating symbols to the gateway I/O is possible under PL7 PRO through the “Variables” – “I/O” menu. Once these symbols are defined, they are used in the configuration window of the TSX PBY 100 coupler previously described.

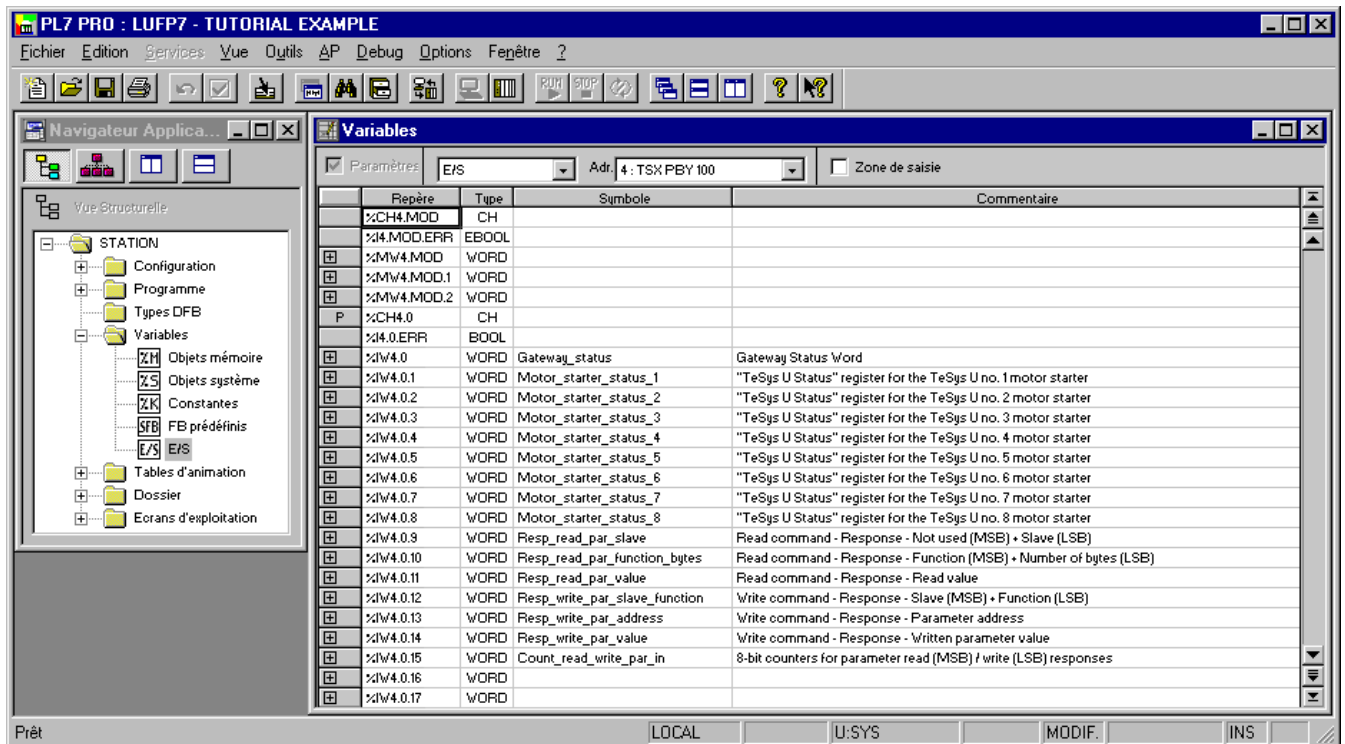



Repère	Type	Symbole	Commentaire
%CH4.MOD	CH		
%I4.MOD.ERR	EBOOL		
%MW4.MOD	WORD		
%MW4.MOD.1	WORD		
%MW4.MOD.2	WORD		
P %CH4.0	CH		
%I4.0.ERR	BOOL		
%I4.0	WORD	Gateway_status	Gateway Status 'word
%I4.0.1	WORD	Motor_starter_status_1	"TeSys U Status" register for the TeSys U no. 1 motor starter
%I4.0.2	WORD	Motor_starter_status_2	"TeSys U Status" register for the TeSys U no. 2 motor starter
%I4.0.3	WORD	Motor_starter_status_3	"TeSys U Status" register for the TeSys U no. 3 motor starter
%I4.0.4	WORD	Motor_starter_status_4	"TeSys U Status" register for the TeSys U no. 4 motor starter
%I4.0.5	WORD	Motor_starter_status_5	"TeSys U Status" register for the TeSys U no. 5 motor starter
%I4.0.6	WORD	Motor_starter_status_6	"TeSys U Status" register for the TeSys U no. 6 motor starter
%I4.0.7	WORD	Motor_starter_status_7	"TeSys U Status" register for the TeSys U no. 7 motor starter
%I4.0.8	WORD	Motor_starter_status_8	"TeSys U Status" register for the TeSys U no. 8 motor starter
%I4.0.9	WORD	Resp_read_par_slave	Read command - Response - Not used (MSB) • Slave (LSB)
%I4.0.10	WORD	Resp_read_par_function_bytes	Read command - Response - Function (MSB) • Number of bytes (LSB)
%I4.0.11	WORD	Resp_read_par_value	Read command - Response - Read value
%I4.0.12	WORD	Resp_write_par_slave_function	Write command - Response - Slave (MSB) • Function (LSB)
%I4.0.13	WORD	Resp_write_par_address	Write command - Response - Parameter address
%I4.0.14	WORD	Resp_write_par_value	Write command - Response - Written parameter value
%I4.0.15	WORD	Count_read_write_par_in	8-bit counters for parameter read (MSB) / write (LSB) responses
%I4.0.16	WORD		
%I4.0.17	WORD		

4. Software Implementation of the Gateway

4.2.12. Using and Monitoring the TSX PBY 100 Coupler Configuration

After validating all the changes previously made, you may check the configuration of the TSX PBY 100 coupler, the Profibus-DP network, and the LUFF7 gateway by downloading the PL7 PRO application to the PLC and conducting a monitoring operation using the TSX PBY 100 coupler debug screen.

- Transfer the application from the PC to the PLC by running the “Transfer program...” option from the “PLC” menu (or click on the  button) and selecting “PC -> PLC”.
- Switch from the OFFLINE to the ONLINE mode by running the “Connect” option from the “PLC” menu (or click on the  button).
- Initialize and start the PLC application using the “Init...” and “Run...” options from the “PLC” menu.
- Open the “Hardware configuration” and the TSX PBY 100 board configuration. Then, switch from “Configuration” to “Debug” and select the line that corresponds to the LUFF7 gateway.

The content of the “PROFIBUS-DP diagnostic data” frame enables you to view the gateway’s Profibus-DP diagnostics, while the “PROFIBUS-DP slave data” frame enables you to view and change the values of the gateway I/O. An example is given on the right.

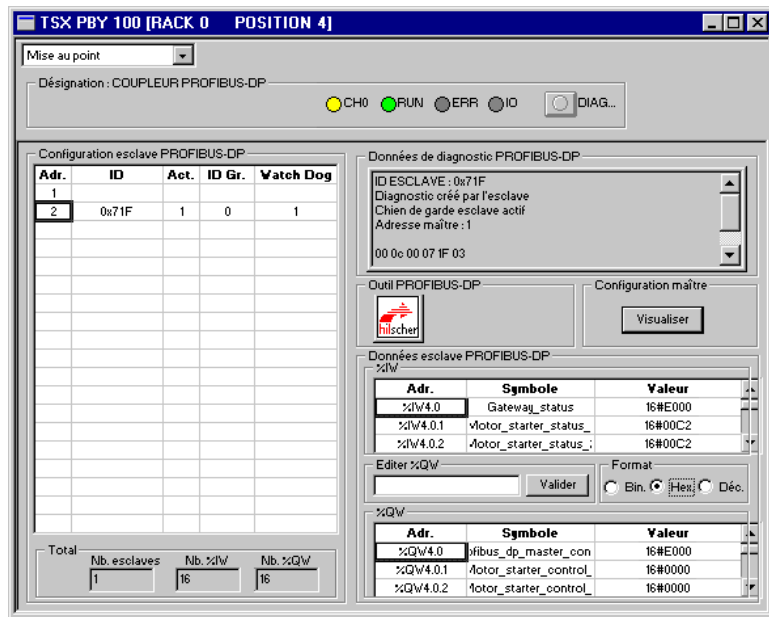

4.2.13. Developing a Profibus-DP Application

The Profibus-DP master PLC taken as an example is a TSX 57353 v5.1, marketed by *Telemecanique*. A sample PLC application, developed under PL7 PRO, is presented in Appendix D: Sample Use under PL7 PRO. This example uses the PLC, the gateway and the 8 TeSys U motor starters shown in the Software Implementation of the Gateway.

4. Software Implementation of the Gateway

4.3. Description of Services Assigned to Gateway I/O

Managing the downstream Modbus network: Refer to chapter 5.2 for a detailed description of that service, and to Appendix C: LUF7 Gateway Initialization and Diagnostics paragraph, for an advanced sample use. In the case of the gateway's default configuration, under ABC-LUFP Config Tool, the "Control/Status Byte" field of the "ABC-LUFP" element is equal to "Enabled but no startup lock."

Periodic communications (inputs): The value of each of the 8 words for this service corresponds to the value of the status register of a TeSys U motor starter (register located at address 455).

Periodic communications (outputs): The value of each of the 8 words for this service corresponds to the value to be sent to the command register of a TeSys U motor starter (register located at address 704).

Refer to Appendix D: Controlling and Supervising the 8 TeSys U Motor Starters, for a sample use of these "periodic communications" services.

Aperiodic communications: Refer to Appendix D: Reading and Writing Any TeSys U Motor Starter Parameter paragraph, for a simple example of these "aperiodic communications".

These aperiodic communications services offer functions similar to those of "parameter area PKW" which can be found on certain *Schneider Electric* products, such as some ATV drives.

- **Sample reading of a motor starter parameter:**

Reading of the 1st fault register (address = 452 = 0x01C4) on TeSys U motor starter no. 5.

The initial values of %QW4.0.15 and %IW4.0.15 are equal to 0x0613.

The result of the reading is 0x0002 (magnetic fault).

Output	Value	Meaning (MSB + LSB)
%QW4.0.9	0x0503	Slave no. + Function no.
%QW4.0.10	0x01C4	Parameter address
%QW4.0.11	0x0001	Number of parameters
%QW4.0.15	0x0713	"Trigger byte" for the query (PF)

Input	Value	Meaning (MSB + LSB)
%IW4.0.9	0x0005	(not used) + Slave no.
%IW4.0.10	0x0302	Slave no. + Number of bytes
%IW4.0.11	0x0002	Value read
%IW4.0.15	0x0713	"Trigger byte" for the response (PF)

- **Sample writing of a motor starter parameter:**

Writing of the 2nd command register (address = 705 = 0x02C1) on TeSys U motor starter no. 7 at the value 0x0006 (clear statistics + reset thermal memory).

The initial values of %QW4.0.15 and %IW4.0.15 are equal to 0x0713.

The result of the writing is a command echo, that is to say that the values of the "address parameter" and "value to be written" fields are identical in both the query and the response.

Output	Value	Meaning (MSB + LSB)
%QW4.0.12	0x0706	Slave no. + Function no.
%QW4.0.13	0x02C1	Parameter address
%QW4.0.14	0x0006	Value to be written
%QW4.0.15	0x0714	"Trigger byte" for the query (PF)

Input	Value	Meaning (MSB + LSB)
%IW4.0.12	0x0706	Slave no. + Function no.
%IW4.0.13	0x02C1	Parameter address
%IW4.0.14	0x0006	Written value
%IW4.0.15	0x0714	"Trigger byte" for the response (PF)

There is no error check performed on data transmitted using the aperiodic services described above. Incorrect values written to the outputs that correspond to the aperiodic communication services will lead to the transmission of an incoherent Modbus frame. This incoherent Modbus frame may return an error, or lead to unexpected behavior of the slave devices.

WARNING

RISK OF UNINTENDED EQUIPMENT OPERATION

The user must perform error checking and appropriate error handling for values written to the outputs corresponding to the aperiodic communications services. Incorrect values sent to the aperiodic services outputs can lead to unexpected system behavior.

Failure to follow this instruction can result in death, serious injury, or equipment damage.

5. Gateway Initialization and Diagnostics

The chapter describes the principle used to initialize and carry out diagnostics on the gateway using each of the three options offered by the gateway. These options can be configured via ABC-LUFP Config Tool, by changing the assignment of the “Control/Status Byte” field for the “ABC-LUFP” element (see chapter 6.13.2). These options are:

<u>“Control/Status Byte” field:</u>	<u>Meaning:</u>
Enabled	Full Management
Enabled but no startup lock	Diagnostic and Control
Disabled.....	Simplified Operation

The option chosen in the default configuration is “Enabled but no startup lock.”

Full Management	Management in the PLC application of : → Start-up of Modbus cyclic exchanges → Modbus slave(s) activation / deactivation → Modbus network diagnostic.
Diagnostic and Control	Management in the PLC application of : → Modbus slave(s) activation / deactivation → Modbus network diagnostic.
Simplified Operation	→ Automatic start-up of Modbus cyclic exchanges → No Modbus slave(s) activation / deactivation → No Modbus network diagnostic

5.1. Full Management

The Profibus master manages the start-up of Modbus cyclic exchanges, the Modbus slaves activation / deactivation, and Modbus network diagnostic by means of 2 words:

- A Profibus-DP command Word
 which is transmitted by the PLC application,
 and is associated to addresses 0x0200 and 0x0201 of the gateway output memory
- A Gateway Status Word
 which is transmitted by the gateway
 and is associated to addresses 0x0000 and 0x0001 of the gateway input memory

The Gateway Status Word is not refreshed cyclically. The updating of this word is based on a toggle-bit system which must be managed in the PLC application:

- Diagnostic is refreshed by the gateway using toggle bit B15
- New command from the Profibus master is sent using toggle bit B14

5. Gateway Initialization and Diagnostics

5.1.1. Profibus-DP master command Word

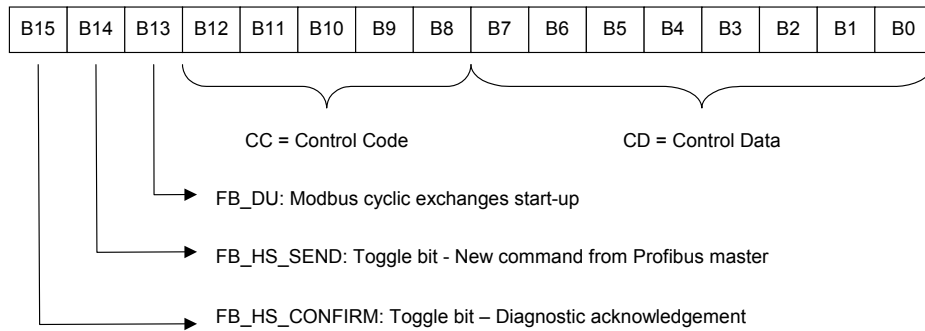

See the detailed description of each bit in chapter **Erreur ! Source du renvoi introuvable..**

5.1.2. Gateway Status Word

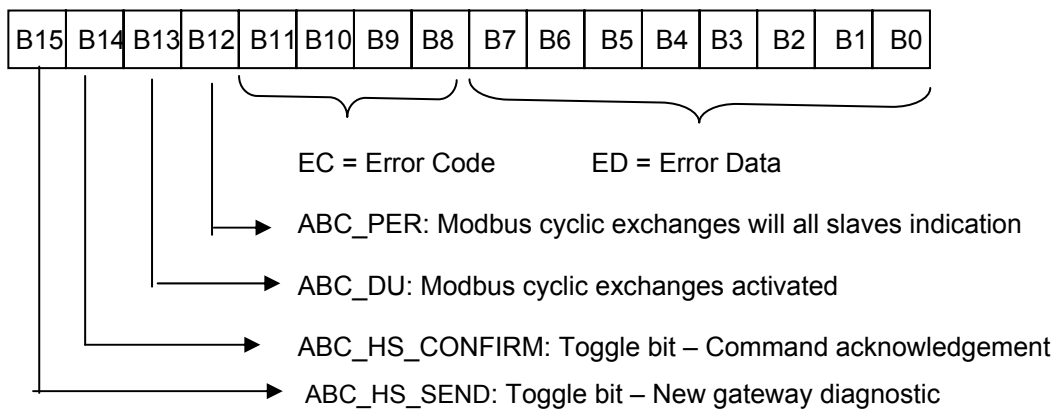

See the detailed description of each bit in chapter **Erreur ! Source du renvoi introuvable..**

5.2. Diagnostic and Control

The Profibus master manages the Modbus slaves activation / deactivation and the Modbus network diagnostic using the same 2 words as those of Full Management.

Bits concerning Modbus cyclic exchanges management are inactive.

5.2.1. Profibus-DP master command Word

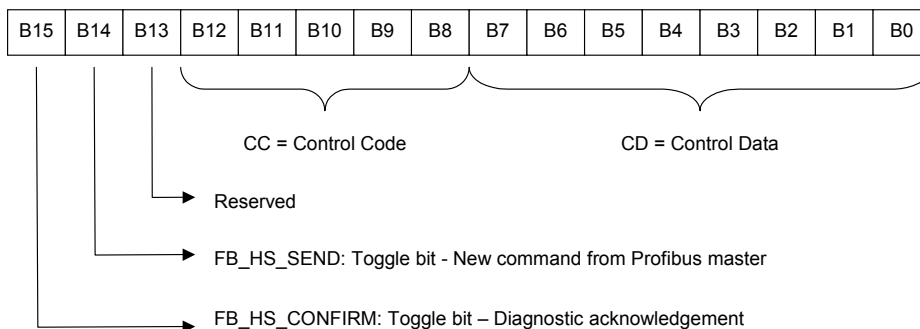

See the detailed description of each bit in chapter **Erreur ! Source du renvoi introuvable..**

5. Gateway Initialization and Diagnostics

5.2.2. Gateway Status Word

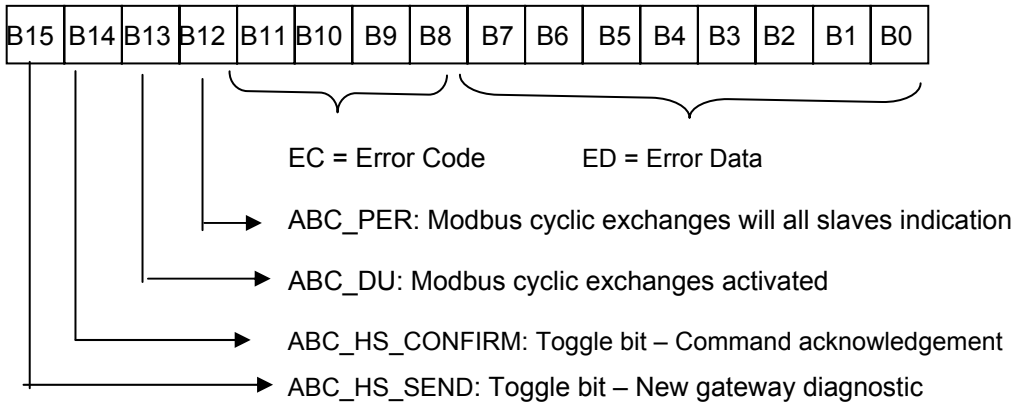

See the detailed description of each bit in chapter **Erreur ! Source du renvoi introuvable.**

In the "Full management" and "Diagnostic and Control" modes, it is important that you configure your Profibus master so that it has access to the first two bytes of the gateway's output data area, as well as to the first two bytes of the gateway's input data area.

⚠ WARNING

MISCONFIGURATION OF LUFP• GATEWAY'S DATA AREAS

Configure your Profibus master so that it has access to the first two bytes of the gateway's output data area, as well as to the first two bytes of the gateway's input data area. Failure to configure access to these bytes can result in an inability to stop Modbus communications, and prevent logging of error conditions for later evaluation. Either consequence may cause unintended equipment operation.

Failure to follow this instruction can result in death, serious injury, or equipment damage.

See chapter 4.2, for more information.

5.3. Simplified Operation

The two 16-bit registers located at addresses 0x0000-0x0001 (inputs) and 0x0200-0x0201 (outputs) are no longer used. Thus, these two addresses can be used to exchange data with the Modbus slave.

No diagnostic is sent back to the PLC. The Profibus master's command word and the gateway's status word do not exist during simplified operations.

5. Gateway Initialization and Diagnostics

5.4. Description of the Profibus-DP master command Word

The output word located at addresses 0x0200 (MSB) and 0x0201 (LSB) in the gateway's output memory constitutes the Profibus-DP master command word. Its structure is described below:

Bits	Description
15	<p>FB_HS_CONFIRM: Acknowledgement bit of a gateway diagnostic</p> <p>The Profibus master must compare the value of the FB_HS_CONFIRM bit to the value of the ABC_HS_SEND bit (bit 15 in the gateway's status word). If these two values are different, this means that the gateway has transmitted a new diagnostic to the Profibus master.</p> <p>To tell the gateway that it has read a diagnostic, the Profibus master must copy the value of the ABC_HS_SEND bit to the FB_HS_CONFIRM bit. This allows the gateway to issue a new diagnostic.</p> <p>Summary:</p> <ul style="list-style-type: none"> • If (FB_HS_CONFIRM = ABC_HS_SEND) → The gateway's status word contains a diagnostic which has already been acknowledged by the Profibus master. So the gateway is free to use this status word to place another diagnostic there. • Else → A new diagnostic is available in the gateway's status word. The Profibus master can read this diagnostic, but must also copy the value of ABC_HS_SEND to FB_HS_CONFIRM in order to allow the gateway to generate new diagnostics.
14	<p>FB_HS_SEND: Toggle bit - New command from the Profibus master</p> <p>Before changing the value of FB_DU, the Profibus master must compare the values of FB_HS_SEND and ABC_HS_CONFIRM (bit 14 of the gateway's status word). If these two values are different, this means that the gateway has not yet acknowledged the previous Profibus-DP master command. Else, the Profibus master can issue a new command, updating the FB_DU bit according to the nature of its command (shutdown or activation of Modbus exchanges), then toggling the value of the FB_HS_SEND bit to inform the gateway that it has sent it a new command.</p> <p>Summary:</p> <ul style="list-style-type: none"> • If (FB_HS_SEND ≠ ABC_HS_CONFIRM) → The Profibus-DP master command word still contains a command which has not yet been acknowledged by the gateway. So the Profibus master cannot use this word to place a new command in it. • Else → The previous command of the Profibus master has been acknowledged by the gateway, which allows it to transmit a new command. In this case, it changes the value of the FB_DU bit, then toggles the value of the FB_HS_SEND bit.
13	<p>FB_DU: Modbus exchange startup (Reserved if "Diagnostic and Control")</p> <p>The setting of this bit to one by the Profibus master allows communications between the gateway and the Modbus slaves. Resetting it to zero is used to inhibit them.</p> <p>When the Profibus master sets this bit to one, it is preferable for all of the output data it has placed in the gateway's output memory to be up-to-date ("FB_DU" means "FieldBus – Data Updated"). If they are not, this data will be transmitted to the Modbus slaves "as is".</p> <p>NOTE: As long as FB_DU is not set to 1 by the Profibus-DP master, the gateway does not send any Query to the Modbus slaves. This bit is primarily used by a Profibus-DP master to prevent the gateway from sending invalid data to them.</p>
8-12	<p>CC: Control Code for activation / deactivation of Modbus slave(s)</p> <p>Code of the command sent by the Profibus master to the gateway in order to activate or inhibit the communications with one or more Modbus slaves (see CC-CD table).</p>
0-7	<p>CD: Control Data for activation / deactivation of Modbus slave(s)</p> <p>Data item associated with the CC control code (see CC-CD table).</p>

5. Gateway Initialization and Diagnostics

The correct use of this command word by the Profibus master, to transmit a new command to the gateway, goes through the following steps:

- checking of (FB_HS_SEND = ABC_HS_CONFIRM). If FB_HS_SEND = ABC_HS_CONFIRM, then
- the Modbus exchange startup command (FB_DU) is updated,
- the control of the Modbus slaves (through CC and CD) is updated if the master wants to inhibit / activate one or more slaves,
- the value of the FB_HS_SEND bit is inverted.

NOTE: It is possible to simplify this use as follows:

- The FB_DU and FB_HS_SEND bits are set to one to activate the Modbus communications.
- The FB_DU and FB_HS_SEND bits are reset to halt Modbus communications.

Though both 8-bit and 16-bit writes to the Profibus-DP master command Word are permissible in theory, writing directly to the Profibus-DP master command word in 16-bit format can cause errors. Such 16-bit writes can disrupt the operation of the transfer of the gateway diagnostics (undesired change to FB_HS_CONFIRM).

WARNING

RISK OF UNINTENDED EQUIPMENT OPERATION

Do not write 16-bit data directly to the Profibus-DP master command word. Writing to this word using a 16-bit format can disrupt the transfer of Gateway diagnostics information to the master. Depending on the user's configuration, unintended equipment operation may result.

Instead of using 8-bit or 16-bit writes, you should write to the Profibus-DP Master Command Word on a bit-by-bit basis. For example, to update FB_DU, you should only write the value of bit 13 (*i.e.* %QW4.0:X13 in the case of the default configuration) without modifying the other bits of this word.

Failure to follow this instruction can result in death, serious injury, or equipment damage.

The values of the CC and CD fields are described in the table below:

CC	Description of the command	CD	Notes
2#00000	No command	—	—
2#10000	Disable a node	Modbus address of the slave to disable	The gateway inhibits <i>all</i> the Modbus exchanges (Commands <i>and</i> Transactions) configured for the corresponding Modbus slave. Note: In the case of the LUFF7 default configuration, please note that disabling the slave at address 1 (<i>i.e.</i> "TeSys U n°1") will also inhibit the two Transactions designed to read / write any parameter of any slave.
2#10001	Enable a node (1)	Modbus address of the slave to enable	The gateway activates <i>all</i> the Modbus exchanges (Commands <i>and</i> Transactions) configured for the corresponding Modbus slave.
2#10010	Enable several nodes (1)	Number of Modbus slaves to enable	The gateway activates <i>all</i> the Modbus exchanges (Commands <i>and</i> Transactions) configured for the first CD Modbus slaves and inhibits <i>all</i> the Modbus exchanges configured for the rest of the Modbus slaves. If CD is equal or greater than the total number of slaves, then all slaves are activated. <i>Example:</i> In the case of the default configuration, if CD = 5, then the 5 first slaves ("TeSys U n°1" to "TeSys U n°5") will be activated while the 3 remaining slaves ("TeSys U n°6" to "TeSys U n°8") will be inhibited.

(1) By default, all nodes are activated. Hence, it is not necessary to enable a node that has not been disabled first.

5. Gateway Initialization and Diagnostics

5.5. Description of the Gateway Status Word

The input word located at addresses 0x0000 (MSB) and 0x0001 (LSB) in the gateway's input memory constitutes the gateway's status word. Its structure is described below:

Bits	Description
15	ABC_HS_SEND: New gateway diagnostic (See description of bit 15 of the Profibus-DP master command word, FB_HS_CONFIRM.)
14	ABC_HS_CONFIRM: Acknowledgement bit of a Profibus-DP master command (See description of bit 14 of the Profibus-DP master command word, FB_HS_SEND.)
13	ABC_DU: Modbus exchanges activated The gateway activates this bit to tell the Profibus master that all Modbus data located in its input memory area has been updated at least once since the last activation of FB_DU ("ABC_DU" means "ABC – Data Updated"). This Modbus input data includes every data in responses from all Modbus slaves, for both periodic commands and aperiodic commands. This bit is deactivated by the gateway when the FB_DU bit is deactivated, that is to say when the Profibus master demands a shutdown of Modbus exchanges. NOTE: Once it is active, this bit is not deactivated if there are any communication errors with the Modbus slaves. To signal this type of error, the gateway uses bit 12 of its status word.
12	Periodicity of Modbus exchanges The gateway activates this bit provided that it is periodically communicating with all of the Modbus slaves. It deactivates it as soon as it loses communication with one of them. The "Reconnect time (10ms)", "Retries" and "Timeout time (10ms)" elements of each of the Modbus queries (see chapter 6.12.2.2) are used to determine whether communication is lost, then restored. NOTE: If a number of periodic exchanges are configured for the same Modbus slave, only one of them needs to remain active for the periodic communications with this slave to be declared active.
8-11	EC: Error code associated with the Modbus network Code for the error detected on the Modbus network by the gateway and transmitted to the Profibus master (see EC-ED table).
0-7	ED: Error data item associated with the Modbus network Data item associated with the EC error code (see EC-ED table).

The correct use of this status word by the Profibus master, to read a diagnostic generated by the gateway, goes through the following steps:

- 1) checking of (ABC_HS_SEND ≠ FB_HS_CONFIRM). If ABC_HS_SEND ≠ FB_HS_CONFIRM, then
- 2) the value of ABC_DU is read to determine whether all of the Modbus input data are up-to-date,
- 3) the value of the "Periodicity of Modbus exchanges" bit is read to determine whether the periodicity of the Modbus communications has been maintained,
- 4) the values of EC and ED are read to check for any error detected by the gateway on the Modbus network (see table below),
- 5) the value of the ABC_HS_SEND bit is copied to the FB_HS_CONFIRM bit.

This last step is very important if the system is designed to read the gateway diagnostics and perform some action depending on the result. Copying of the value of the ABC_HS_SEND bit to the FB_HS_CONFIRM bit allows the gateway to transmit a future diagnostic, preventing the loss of subsequent error information.

5. Gateway Initialization and Diagnostics

WARNING

RISK OF UNINTENDED EQUIPMENT OPERATION

The user must ensure the Profibus master programming concludes read operations by copying the value of the ABC_HS_SEND bit to the FB_HS_CONFIRM bit. If this step is omitted in applications where gateway diagnostics will be read and acted upon, future diagnostics information will be blocked. Depending on the user's configuration, unintended equipment operation may result.

For example, the disappearance of a Modbus slave (EC = 2#0001) may have perturbing consequences on the communications with the other slaves, due to the future reconnection attempts and timeouts with this faulty Modbus slave. As a consequence, and depending on the needs of your application, it may be very important for the Profibus-DP master to acknowledge each diagnosis in order to be informed as soon as possible of the disappearance of a slave. Thus, your application could take measures to react accordingly (e.g. by inhibiting the faulty slave with CC and CD of the Gateway Command Word).

Failure to follow this instruction can result in death, serious injury, or equipment damage.

The values of the EC and ED fields are described in the table below:

EC	Description of the error	ED	Notes
2#0000	Re-transmissions on the Modbus network	Number of re-transmissions	Total number of re-transmissions carried out on the sub-network, for all slaves.
2#0001	A Modbus slave is missing	Address of the missing Modbus slave	—
2#0010	Several Modbus slaves are missing	—	—
2#0011	Excessive data in a Modbus response	Address of the Modbus slave involved	This error occurs when the gateway receives too much data in the response sent by one of its Modbus slaves.
2#0100	Unknown Modbus error	Address of the Modbus slave involved	—
2#1111	Absence of error	—	This is a “no-error” code used by the gateway whenever the Modbus communications are OK. It is typically used when previously absent Modbus slaves are back on the sub-network.

The re-transmission counter used to signal this error is not reset when the gateway generates this error code. If there are recurrent communication problems on the Modbus network, the gateway will generate this same diagnostic repeatedly, so as to tell the Profibus master the total number of re-transmissions carried out as often as possible. This counter is reset when its value exceeds its maximum value (counter modulo 256: 0xFF → 0x00).

In the case of disconnection of one or several devices on the Modbus sub-network, the LUF7 gateway will first report re-transmission errors several times and then the error “A Modbus slave is missing” or “Several Modbus slaves are missing”. Later on when the LUF7 makes a reconnection attempt, only the re-transmission error will be reported. Due to this, the indication of the errors “A Modbus slave is missing” or “Several Modbus slaves are missing” may be perceived as very brief.

6. Configuring the Gateway

Each part of this chapter describes a separate step allowing the user to personalize the gateway configuration, according to his own particular needs. Each part gives an introduction to a basic operation isolating it from the rest of the configuration and describing the operations to be carried out using ABC-LUFP Config Tool (mainly) and SyCon (where necessary), and their implications for the gateway's general behaviour.

In each case, the first two steps are required, as they allow you to establish the dialogue between the gateway and the PC software allowing you to configure it, that is to say ABC-LUFP Config Tool.

We strongly recommend that you read chapter 4, because all of the operations carried out in ABC-LUFP Config Tool or SyCon are based on the principle that we are using the default configuration of the LUFP7 gateway.

6.1. Connecting the Gateway to the Configuration PC

This step is required when setting up the gateway configuration application, ABC-LUFP Config Tool.

Connecting the gateway to one of the serial (COM) ports on a PC requires a straight PowerSuite cable and a RS232/RS485 converter. These two items are the same as those allowing dialogue with drives and soft start-stop units using the **PowerSuite** application and are both available from the catalogue (ref.: VW3 A8 106).

Ensure that you use the "POWERSUITE" cable and the "RS232 / RS485 PC" converter. An "ATV28 before 09 / 2001" cable and an "ATV 58" converter are also supplied with these items, but they should not be used with the LUFP7 gateway.

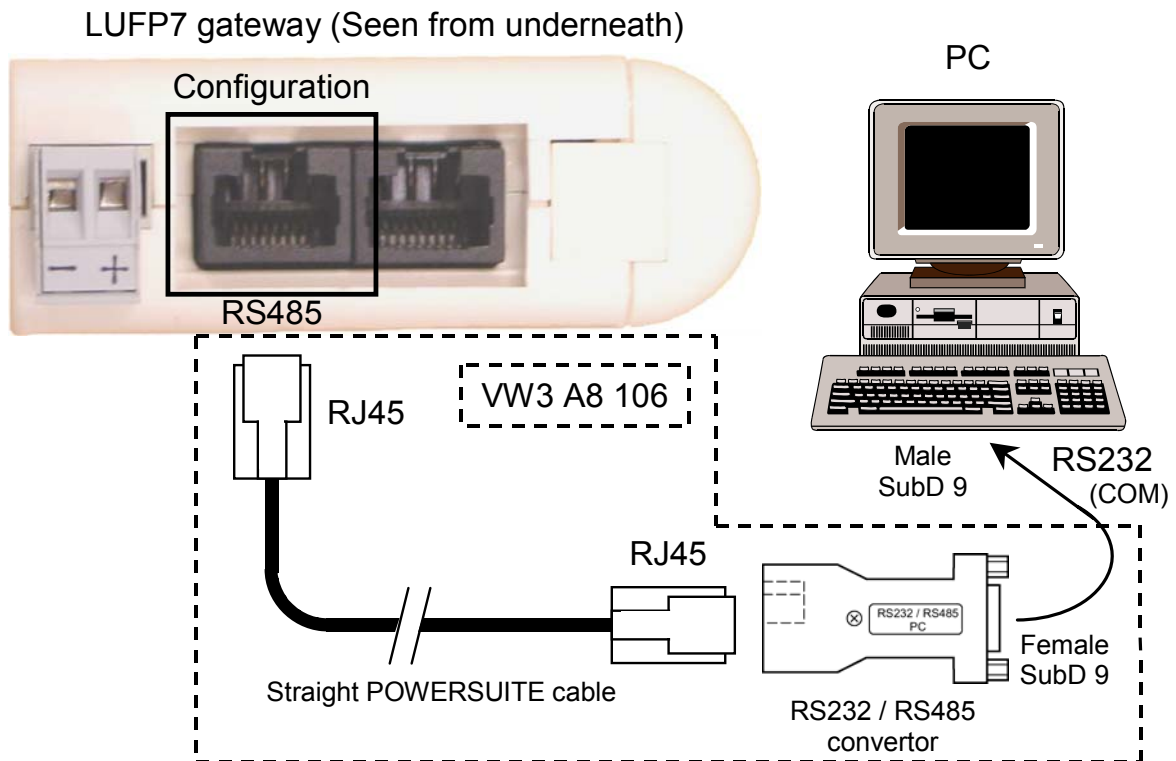

Once the gateway has been connected to a PC with the PowerSuite cable and the RS232/RS485 converter, you can change its configuration using "ABC-LUFP Config Tool". This configurator also allows you to carry out a few diagnostics on the gateway.

6. Configuring the Gateway

6.1.1. Pin Outs

— LUF7 (Configuration) —

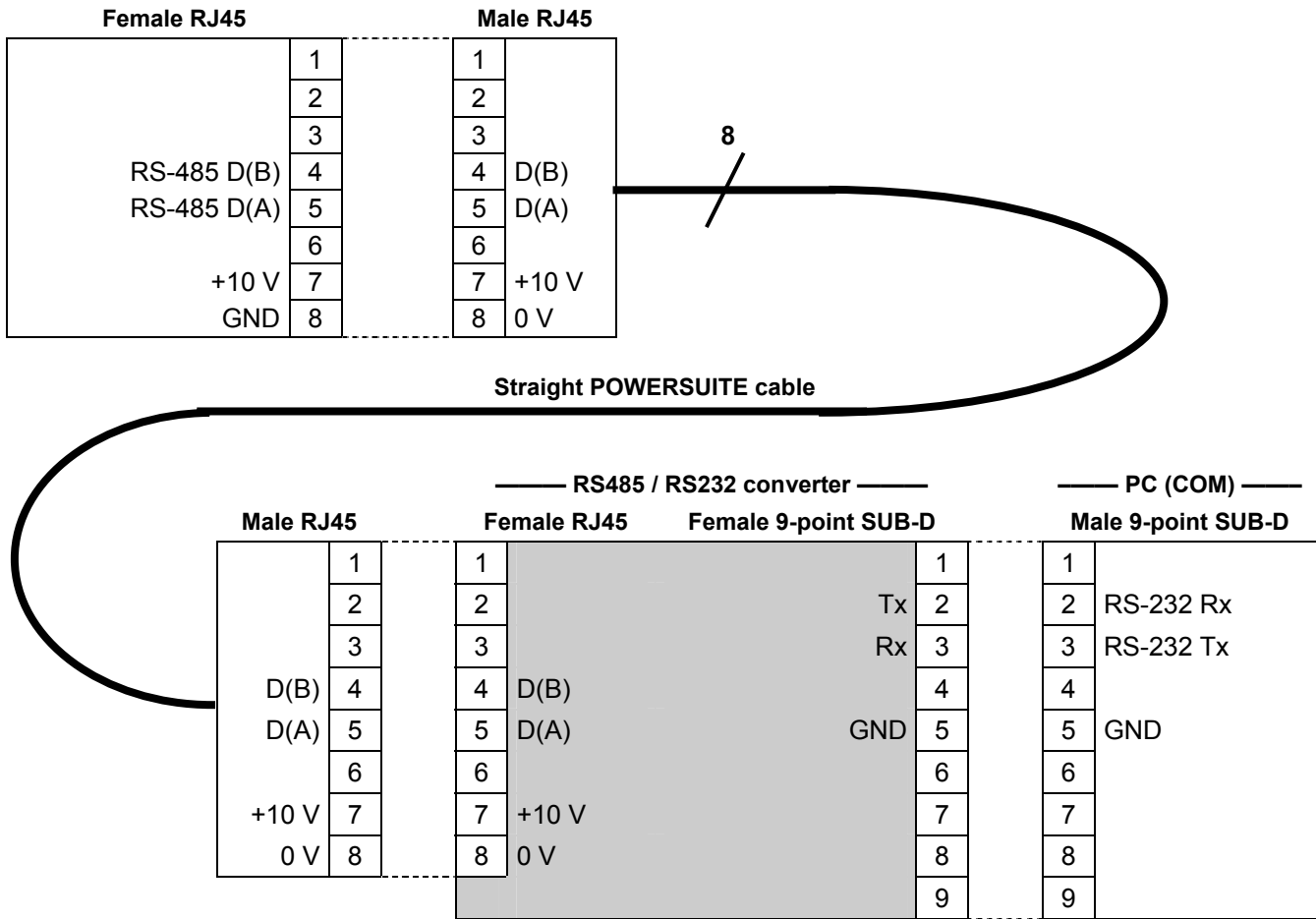

NOTE: The inversion of the Rx and Tx signals between the gateway and the PC is shown on the 9-point SUB-D connectors, because beyond this junction, the RS-232 signals are replaced by the D(A) and D(B) polarizations of the RS-485 signals.

6.1.2. RS-232 Link Protocol

There is no need to configure the PC's COM port, as ABC-LUFP Config Tool uses a specific setup which replaces the one for the port being used. This replacement is temporary and is cancelled as ABC-LUFP Config Tool stops using this serial port, that is to say when ABC-LUFP Config Tool is closed.

6. Configuring the Gateway

6.2. Installing ABC-LUFP Config Tool

The minimum system requirements for ABC-LUFP Config Tool are as follows:

- Processor Pentium 133 MHz
- Free hard disk space 10 Mb
- RAM 8 Mb
- Operating system MS Windows 95 / 98 / ME / NT / 2000 / XP
- Browser MS Internet Explorer 4.01 SP1

The ABC-LUFP Config Tool installation program can be found on the <http://www.telemecanique.com> website. To install it, run “ABC-LUFP_Setup.exe”, then follow the on-screen instructions.

You can read about how to use ABC-LUFP Config Tool in a user manual entitled **AnyBus Communicator – User Manual** which is also on the <http://www.telemecanique.com> website: “ABC_User_Manual.pdf”. We strongly recommend that you read this manual when using ABC-LUFP Config Tool, because this guide will only describe the various features it provides in relation to using the LUFP7 gateway.

6. Configuring the Gateway

6.3. Connecting to / Disconnecting from the Gateway

In ABC-LUFP Config Tool, the connection to the gateway must be performed manually.

But first, you should check which serial port ABC-LUFP Config Tool will use for this connection. In the “Tools” menu, the “Port” sub-menu will reveal which serial ports (COM1, COM2, etc.) are currently available. If several COM ports are available, select, in this sub-menu, the port you intend to use for connecting to and configuring the gateway.

An example is given on the right:

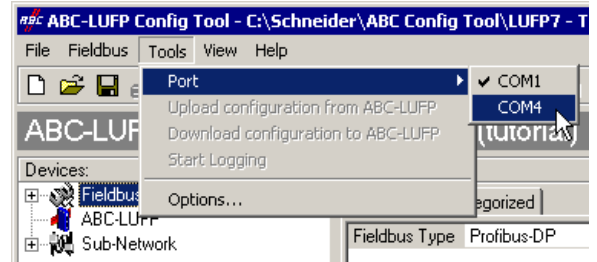

NOTE: If all the serial ports of your PC are already used by other applications, you must first close ABC-LUFP Config Tool, then “free” a serial port by disconnecting, closing, or terminating an application that currently uses a serial port. Afterward, restart ABC-LUFP Config Tool because COM ports are only scanned during its start-up; the freed COM port should now be useable by it.

To connect ABC-LUFP Config Tool to the gateway:

- right-click on the “ABC-LUFP” element and click on “Connect” in the popup menu that appears, **or**
- select the “ABC-LUFP” element and choose “Connect” in the “ABC-LUFP” menu, **or**
- click on the  button.

Once connected, you can disconnect ABC-LUFP Config Tool from the gateway by:

- right-clicking on the “ABC-LUFP” element and clicking on “Disconnect” in the popup menu that appears, **or**
- selecting the “ABC-LUFP” element and choosing “Disconnect” in the “ABC-LUFP” menu, **or**
- clicking on the  button.

The rightmost part of the status bar of ABC-LUFP Config Tool displays its current connection mode:

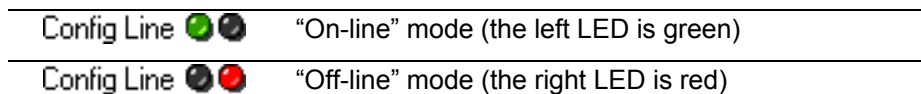

In “On-line” mode, ABC-LUFP Config Tool periodically polls the gateway in order to detect if the gateway has been disconnected.

When an unwanted disconnection does occur, ABC-LUFP Config Tool goes to “Off-line” mode (the red LED is displayed) and automatically retries to connect itself to the gateway. The “Searching for ABC-LUFP” window is visible for the whole duration of this search.

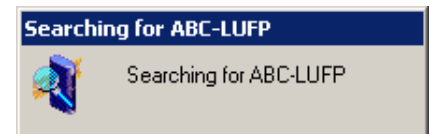

If the search fails, ABC-LUFP Config Tool asks the user “No Module was found, retry?”.

- Should the user select the “Cancel” button, ABC-LUFP Config Tool remains in “Off-line” mode.
- Should he select the “Retry” button, ABC-LUFP Config Tool resumes the search for an ABC-LUFP gateway.

6. Configuring the Gateway

6.4. Importing the Gateway Configuration

Before you can make any changes to the gateway configuration, you will first need to import its current configuration. If you already have this configuration on your hard disk, all you will need to do is open the file corresponding to this configuration.

Check that the gateway has a valid configuration and that it is working properly, that is to say that LED ⑥ GATEWAY is flashing green (see page 25)

In ABC-LUFP Config Tool, choose “Upload configuration from ABC-LUFP” from the “File” menu or click on the  button, in the ABC-LUFP Config Tool toolbar. A window called “Upload” will then open and a progress bar shows you the state of progress of the gateway configuration uploading process. This window disappears as soon as the whole configuration has been successfully uploaded.

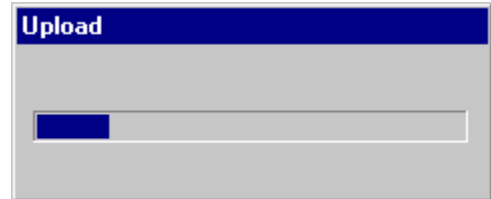

This step is particularly important if you wish to read details about the content of the gateway’s default configuration, after unpacking it. You can then use this configuration as a template for any changes you wish to make subsequently, thus avoiding having to create all of the items and reducing the potential risk of error.

NOTE:

- Save this configuration to your hard disk so that it is always available. This will allow you to reconfigure the gateway “cleanly” should the configuration become invalid.
- The LUFP7 gateway’s default configuration can be found on the <http://www.telemecanique.com> website: “LUFP7.cfg”.

6. Configuring the Gateway

6.5. Transferring a Configuration to the Gateway

When using ABC-LUFP Config Tool, you can transfer the configuration you are editing to the gateway at any time.

Choose “Download configuration to ABC-LUFP” from the “File” menu or click on the  button, in the ABC-LUFP Config Tool toolbar.

ABC-LUFP Config Tool initializes a check test of the gateway type.

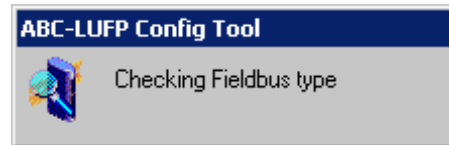

NOTE: During this very fast test, the PC should not carry out any other operations, as this could lead to ABC-LUFP Config Tool apparently freezing up and slow down the PC's general operation for several minutes. After the test is complete, the PC will return to full speed, and may be used normally.

Once this test has finished, a window called “Download” opens and a progress bar shows the state of progress for the transfer of the configuration to the gateway.

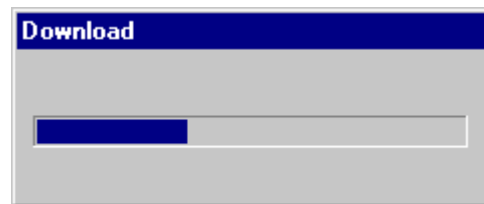

NOTE: Do not interrupt this operation, otherwise you will have to start it again from the beginning.

Check that the transfer has been correctly carried out: LED  GATEWAY should be flashing green (see page 25).

If this LED is flashing red/green, save the configuration you were editing, open the file containing the default configuration for LUFP7 gateways, then transfer it to the gateway. This will restore it to a known initial state. You can then continue with the configuration you were transferring, and make any corrections which may be necessary.

If the gateway and its master DPM1 are both connected via a Profibus-DP network, LED  FIELDBUS DIAG (see page 25) will begin to flash red at a frequency of 1 Hz if changes have to be made under SyCon. This occurs if you change the total size of the input data and/or the total size of the output data exchanged with the Modbus slaves.

6.6. Monitoring the Content of the Gateway's Memory

One of the main commands that you will need to use when setting up the gateway is the command allowing you to read the contents of the gateway's memory and to display it in a window used for this purpose. This will be particularly useful when you are working on your PLC configurations and applications. However, it only shows data from the “Data” and “Preset Data” fields (and also those from the “Variable Data” fields, reserved for the Transactions) configured in the “Query” and “Response” elements of just one of the Modbus slaves, plus the content of the gateway's two reserved registers, located at memory addresses 0x0000-0x0001 (gateway status word) and 0x0200-0x0201 (Profibus-DP master command word).

To monitor the content of the gateway's memory, start by selecting the node corresponding to the Modbus slave whose data you wish to view, then choose “Monitor” from the menu whose name corresponds to the name of the previously selected node. A monitoring window then appears. The sample window shown below corresponds to a view of the contents of the memory exchanged, using the gateway's default configuration, with the “TeSys U n°1” motor starter.

6. Configuring the Gateway

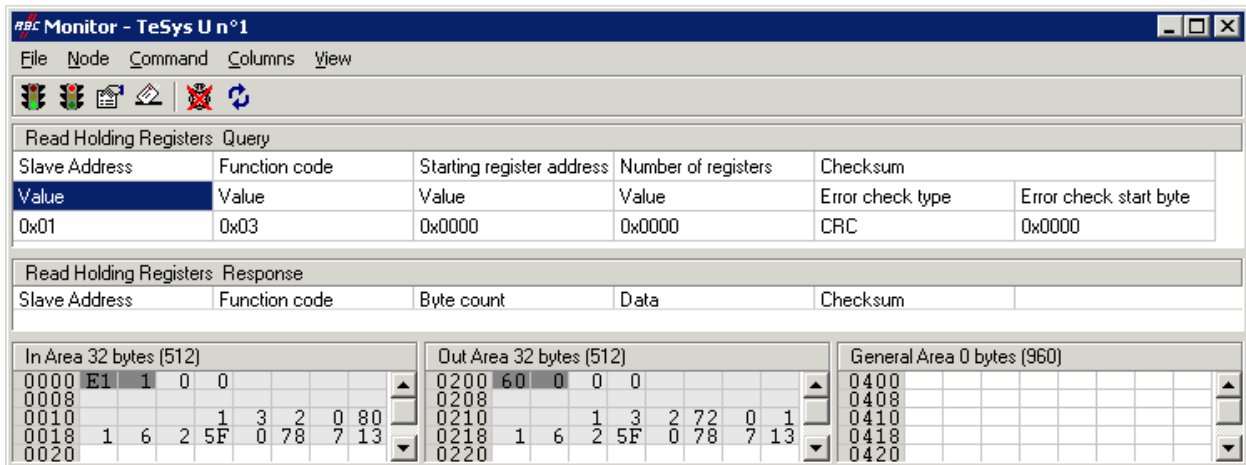

The upper part of this window allows you to choose a Modbus command, to edit its contents, then to send it to the Modbus network (“Command” menu). The response will then be displayed in this same part. Please see chapter 2.10 Node monitor in the ABC-LUFP Config Tool user manual, entitled **AnyBus Communicator – User** for further information about how to use this window. This manual can be found on the CD LU9CD1: “ABC_User_Manual.pdf”.

The lower part of this window allows you to view the content of the gateway’s memory, but only the bytes used in frames for queries and responses frames for commands and transactions configured for the selected node. The values of the gateway’s two reserved words (addresses 0x0000-0x0001 and 0x0200-0x0201) are also shown, whichever node is selected.

In the window shown above, the data displayed correspond to the values at the memory locations designated by the “Data” fields in the commands and transactions configured for the “TeSys U n°1” node, that is to say the following commands: “Read Holding Registers”, “Preset Multiple Registers”, “Transactions 1”, and “Transactions 2”.

NOTE: The data exchanged with the Modbus slave previously selected are displayed MSB-first, that is in the MSB / LSB order (as read from left to right, with growing memory addresses), provided that the “Byte Swap” option from the “Data”, “Preset Data”, or “Variable Data” element of the corresponding Modbus command was set to “No swapping” (see chapter 6.12.2.4). This also holds true for the two reserved words dedicated to the management of the downstream Modbus network.

However, but only as far as the “TeSys U n°1” node is concerned, the data beginning at addresses 0x0013, 0x0018, 0x0212, and 0x0218 (see Appendix C.: Content of the Gateways’s DPRAM Memory paragraph) follow the same byte order than the content of the frames they are related to (see Appendix F: Modbus Commands), from first to last byte (checksum excluded), and following growing addresses in the memory of the gateway. Finally, bytes 0x001E, 0x001F, 0x021E, and 0x021F correspond to the reception and emission counters for these frames (“Trigger bytes” from Transactions 1 and 2).

A brief description of the toolbar buttons of this window is given below:

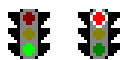

Stop / Start communications with the selected node (see “Node” menu, below)



Select / Send the Modbus command shown in the upper part of the window (see “Command” menu, below)



Stop / Resume refreshing the data displayed in the lower part of the window

6. Configuring the Gateway

The menus of this window allow the user to perform the following actions:

- “File” menu:
 - The “Exit” command closes the “Monitor” window, thus returning to ABC-LUFP Config Tool.
- “Node” menu:
 - The “Start Node” command restarts all the communications configured for the node currently monitored. Since a node is active by default, this command is only useful if the node has been explicitly stopped by the user with the “Stop Node” command (or with one of the commands described in chapter **Erreur! Source du renvoi introuvable.**, using the CC and CD fields).
 - The “Stop Node” command stops all the communications configured for the node currently monitored. This means that all Commands and Transactions configured for the node are inhibited. Please note that in the case of the first node of the LUFP7 default configuration (the “TeSys U n°1” slave), this will also inhibit the two Transactions designed to read / write any parameter of any slave.

Note: The Stop / Start Node commands can be particularly useful when used to isolate one or more nodes in order to investigate Modbus communication problems.
- “Command” menu:
 - The “Select Command” command opens a “Select Command” window that enables the user to select a Modbus command (see chapter 6.12.2).
-). Once selected, the Query and Response frames of this command will be displayed in the upper part of the “Monitor” window. The user can then edit the value associated with each field of the Query frame before sending the command with the “Send Command” command (see below).
 - The “Send Command” command triggers the emission of the Query displayed in the upper part of the “Monitor” window. As soon as a Modbus Response will be received by the gateway, ABC-LUFP Config Tool will display its contents in the upper part of the “Monitor” window.
- “Columns” menu:
 - The “Free” choice configures the three monitoring columns (“In Area”, “Out Area”, and “General Area”) to automatically adjust their width on a 1-byte unit (1 byte, 2 bytes, 3 bytes, etc.) each time the user modifies the width of the “Monitor” window.
 - The “8 Multiple” choice configures the three monitoring columns to automatically adjust their width on an 8-byte unit (8 or 16 bytes) each time the user modifies the width of the “Monitor” window.
- “View” menu:
 - The “Hex” choice configures the three monitoring columns to display all monitored values and memory addresses in Hexadecimal.
 - The “Decimal” choice configures the three monitoring columns to display all monitored values and memory addresses in Decimal.

6. Configuring the Gateway

6.7. Deleting a Modbus Slave

This step allows you, for instance, to free up a location on the downstream Modbus network, known as the “Sub-Network” in ABC-LUFP Config Tool, in order to replace one Modbus slave with another.

In fact the gateway’s default configuration allows it to communicate with eight TeSys U motor starters, which is the maximum number of Modbus slaves.

If the gateway is used to manage exchanges on a Modbus network with fewer than eight TeSys U motor starters, it is preferable to delete the redundant TeSys U motor starters from the gateway. You should carry out this operation using ABC-LUFP Config Tool.

If you are using the aperiodic read/write services, keep in mind that these services are configured using the memory space of the first configured TeSys U Motor starter. Therefore, deleting the first configured TeSys U Motor starter can also result in the deletion of the aperiodic read/write services.

 WARNING
LOSS OF APERIODIC COMMUNICATIONS
Do not delete the first configured TeSys U motor starter if you are using the aperiodic read/write services. Deleting this first device will also delete the aperiodic services. Because these services allow communication with all of the configured Modbus devices, and not just the first device, you may lose communications with all devices, leading to unintended equipment operation.
Failure to follow this instruction can result in death, serious injury, or equipment damage.

Procedure for deleting a Modbus slave

- 1) Select the node corresponding to the Modbus slave you wish to delete from the configuration. If this is the only node remaining in the configuration, you will not be able to delete it, as the downstream Modbus network must include at least one slave.
- 2) Right click on the icon or the name of this Modbus slave. A menu pops up underneath the mouse cursor.
or
In the ABC-LUFP Config Tool main menu, pull down the menu whose name corresponds to the name of the previously selected node.
- 3) On this menu, click on “Delete”. The confirmation window shown below then appears, asking you to either confirm that you want to delete the selected node (“TeSys U n°2” in the example shown here) or cancel the operation.
- 4) If you confirm that you want to delete the node, the menu disappears, along with the previously selected node. Otherwise, the node will still be there once the window disappears.

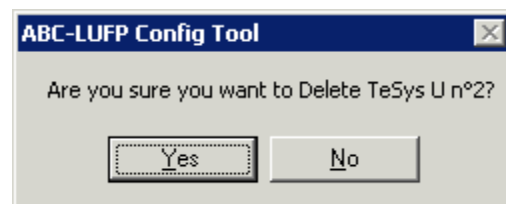

Keyboard shortcut: “Del” key.

Adjusting the gateway’s memory (optional step):

The data previously exchanged between the gateway and the Modbus slave which has just been deleted will free up locations in the gateway’s memory. If you want to optimize the exchanges between the gateway’s memory and the master PLC Profibus-DP coupler inputs/outputs, you will need to change the configuration of all the other Modbus slaves in order to adjust the content of the gateway’s memory.

6. Configuring the Gateway

However, these operations are not necessary when deleting a single slave. Conversely, they become almost essential when most of the Modbus slaves are deleted, because these deletions divide up the gateway's memory.

Please see chapter 6.12, which describes all of the changes you can make to the configuration of each of the Modbus commands.

6.8. Adding a Modbus Slave

This operation allows you to add a Modbus slave whose type is different from those of the other Modbus slaves in the configuration. On the other hand, if the slave type is the same as one of the previously configured slaves, it is preferable to copy this slave rather than to create a new one.

An additional import/export feature also allows you to individually save the complete configuration of a Modbus slave, in order to have access to it in ABC-LUFP Config Tool, from any configuration and at any time.

These two features are only available provided that there are less than 8 Modbus slaves declared, which is not the case in the default configuration, as it comprises 8 TeSys U motor starters.

Adding a new type of Modbus slave:

Use one of the two methods shown below:

- a) Select "Sub-Network", then choose "Add Node" from the "Sub-Network" menu. A new node is added after all the other configured nodes. By default, its name is "New Node".
- b) Select one of the nodes located under the "Sub-Network" element, then choose "Insert New Node" from the menu whose name corresponds to the name of the selected node. A new node is added just before the selected node. By default, its name is "New Node".

All of the steps in configuring the new node are described in chapter 6.11.

Copying a previously configured Modbus slave:

Select the node corresponding to the slave whose configuration you want to copy, then choose "Copy" from the menu whose name corresponds to the name of the selected node. **Keyboard shortcut:** "Ctrl C".

Then use one of the two methods shown below:

- a) Select "Sub-Network", then choose "Paste" from the "Sub-Network" menu. A new node is added after all the other configured nodes. Its name and its whole configuration are identical to that of the node you copied. **Keyboard shortcut:** "Ctrl V".
- b) Select one of the "Sub-Network" nodes, then choose "Insert" from the menu whose name corresponds to the selected node. A new node is added just before the one which is selected. Its name and its whole configuration are identical to that of the node you copied.

6. Configuring the Gateway

As the new node and the original node are identical in every way, you will need to change (1) the name of the node, (2) the address of the corresponding Modbus slave and (3) the location of the data exchanged between the gateway's memory and this Modbus slave. All of these operations are described in chapter 6.11, and in chapter 6.12.

WARNING

DUPLICATE MODBUS ADDRESSES OR GATEWAY MEMORY RANGES

If the user chooses to add a Modbus slave by copying the configuration of an existing Modbus slave, the user must change the added device's Modbus address and the memory locations it uses to exchange data with the gateway. Duplicated Modbus addresses or gateway memory locations may result in communications errors, incorrect information being written to a slave's registers, or in writing the registers of an unintended device. Any of these errors may result in unintended equipment operation.

Failure to follow this instruction can result in death, serious injury, or equipment damage.

Importing/exporting a Modbus slave configuration:

ABC-LUFP Config Tool offers the possibility of independently saving and loading the configuration of a node on the downstream "Sub-Network". For instance, this will allow you to build a library of Modbus slave templates, so that you can use them in any configuration.

To save the configuration of a Modbus slave, select the node it corresponds to, then choose "Save Node" from the menu whose name corresponds to the name of the selected node. A dialog box will then appear asking you to save the configuration (export in XML format).

To insert a node using the XML file containing a Modbus slave configuration as a template, use one of the two methods shown below:

- a) Select "Sub-Network", then choose "Load Node". A dialog box asks you to choose a file containing a Modbus slave configuration (import in XML format). A new node is added after all the other configured nodes. Its name and its whole configuration are identical to those of the Modbus slave, as it was configured when it was saved.
- b) Select one of the "Sub-Network" nodes, then choose "Insert from File" from the menu whose name corresponds to the name of the selected node. A new node is added just before the selected node. Its name and its whole configuration are identical to those of the Modbus slave, as it was configured when it was saved.

You will then change (1) the name of the node, (2) the address of the corresponding Modbus slave and (3) the location of the data exchanged between the gateway's memory and this Modbus slave. All of these operations are described in chapter 6.11, and in chapter 6.12.

WARNING

DUPLICATE MODBUS ADDRESSES OR GATEWAY MEMORY RANGES

If the user chooses to add a Modbus slave by copying the configuration of an existing Modbus slave, the user must change the added device's Modbus address and the memory locations it uses to exchange data with the gateway. Duplicated Modbus addresses or gateway memory locations may result in communications errors, incorrect information being written to a slave's registers, or in writing the registers of an unintended device. Any of these errors may result in unintended equipment operation.

Failure to follow this instruction can result in death, serious injury, or equipment damage.

6. Configuring the Gateway

6.9. Changing the Periodic Data Exchanged with a Modbus Slave

This operation consists of replacing, adding or deleting periodic data exchanged with one of the Modbus slaves. With each of these operations, we shall take the default configuration of the LUFFP7 gateway as an example, that is to say that any changes previously made will have been cancelled at the start of each operation. In addition, the operations to be carried out are shown as part of a targeted example.

Do not forget to save the changes you have made, or to transfer the whole configuration to the gateway. This will allow you to check that the configuration is valid, as the gateway automatically verifies the configuration when it is downloaded.

6.9.1. Replacing a Periodic Input Data Element

We will use the node corresponding to “TeSys U n°3” motor starter for our example. We are trying to replace the monitoring of the “TeSys U Status Register” (address 455 = 0x01C7) with the monitoring of the “1st Fault Register” (address 452 = 0x01C4).

The operation consists of changing the value of the “Starting register address” element of the “Query” from the “Read Holding Registers” command (Modbus command for reading the values of a number of registers).

Select this element, then change its value as shown below. You can enter the address of the parameter in decimal format. ABC-LUFFP Config Tool will automatically convert it to hexadecimal.

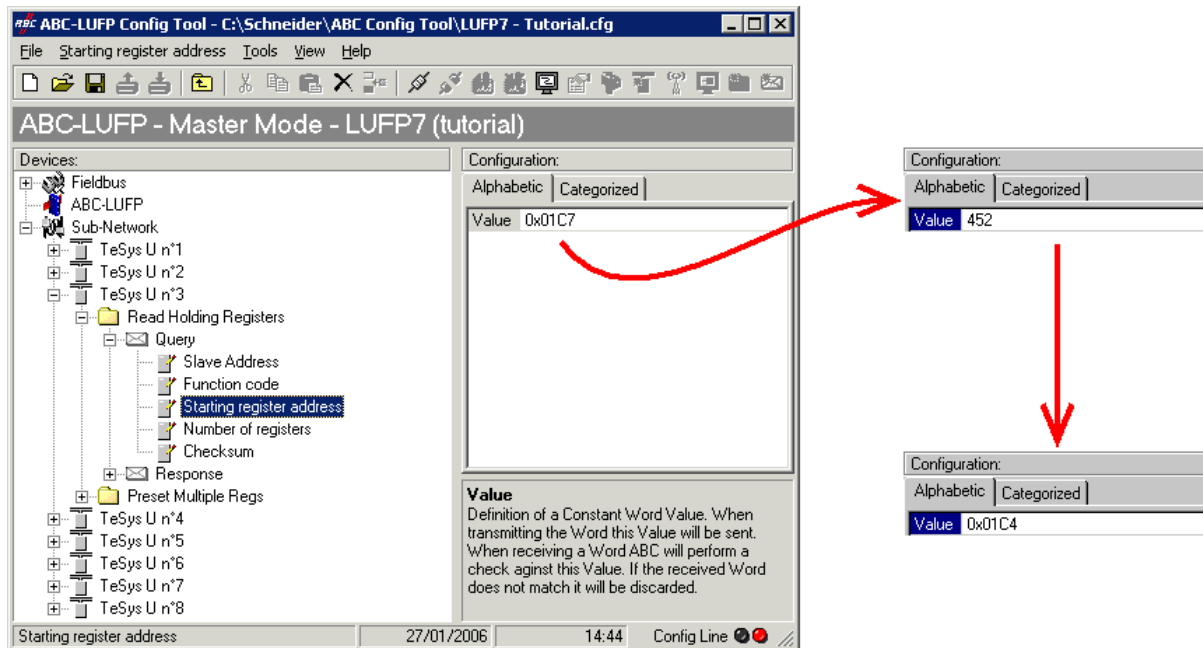

This operation in no way changes the content of the gateway’s memory, because we do not need to change the values of the “Data length” and “Data location” fields of the “Data” element of the “Response” to the aforementioned command. So no additional operations will be necessary, either in ABC-LUFFP Config Tool, or in SysCon.

On the other hand, the Profibus-DP master PLC software will have to take account of the change in the nature of the corresponding input. In Appendix C:, Input Data Memory Area paragraph, the description of the word located at address 0x0006 becomes “value of the motor starter ③ 1st default register”. This word corresponds to the PLC input word %IW4.0.3 (see chapter 4.2.9).

6. Configuring the Gateway

6.9.2. Replacing a Periodic Output Data Element

We will use the node corresponding to “TeSys U n°6” motor starter for our example. We will replace the control of the “Command Register” (address 704 = 0x02C0) with the control of the “2nd Command Register” (address 705 = 0x02C1).

The operation consists of changing the value of the “Starting register address” element in the “Query” and the one of the “Preset Multiple Registers” command (Modbus command for writing values of a number of registers) in the “Response”.

Select “Starting register address” from the “Query”, then change its value as shown below. You can enter the address of the parameter in decimal format. ABC-LUFP Config Tool will automatically convert it to hexadecimal. **Do the same for the “Starting Address” element of the “Response”** because the gateway checks the value of this field when it receives each Modbus response. If the value does not correspond to that of the query, the gateway will ignore the response.

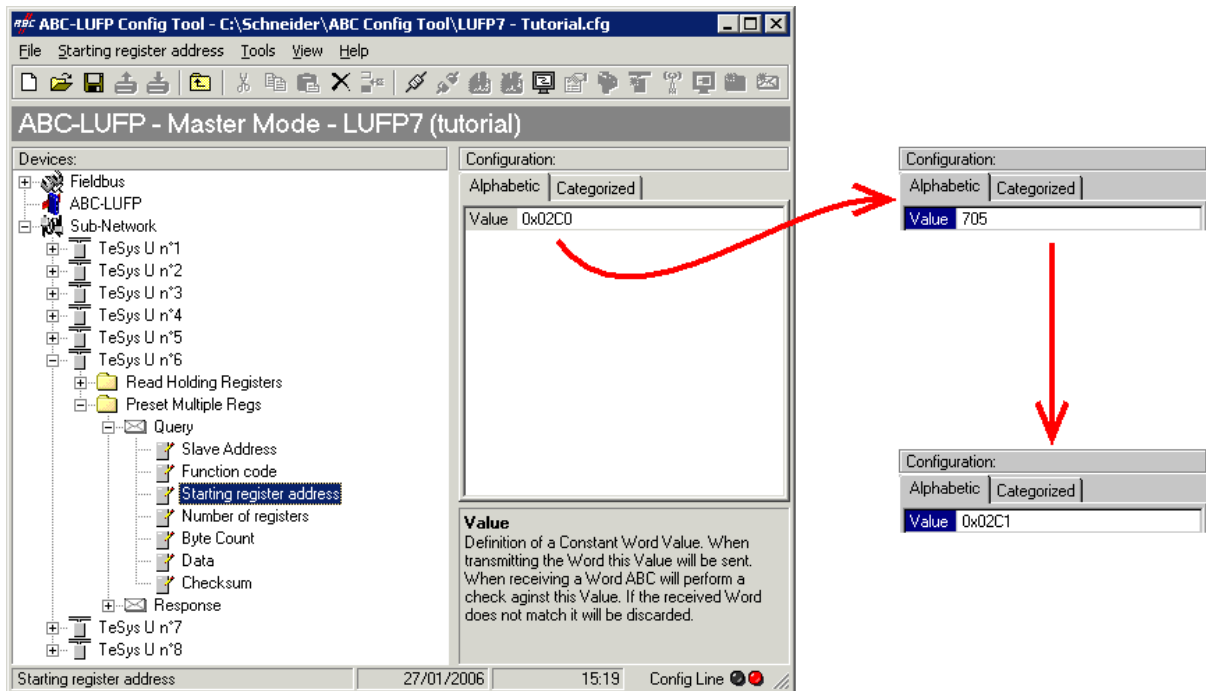

This operation in no way changes the content of the gateway’s memory, because we do not need to change the values of the “Data length” and “Data location” fields of the “Data” element of the “Query”. So no additional operations will be necessary, either in ABC-LUFP Config Tool, or in SyCon.

On the other hand, the Profibus-DP master PLC software will have to take account of the change in the nature of the corresponding output. In Appendix C:, Output Data Memory Area paragraph, the description of the word located at address 0x020C becomes “value of the motor starter © 2nd command register”. This word corresponds to PLC output word %QW4.0.6 (see chapter 4.2.9).

6. Configuring the Gateway

6.9.3. Increasing the Amount of Periodic Input Data

We will use the node corresponding to “TeSys U n°2” motor starter for our example. We will complete the monitoring of this motor starter starting from the currently monitored register, that is to say “TeSys U Status Register” (address 455 = 0x01C7), and going as far as the “Reserved: 2nd Warning Register” (address 462 = 0x01CE). The number of registers monitored is therefore increased from 1 to 8.

In this case, there are quite a lot of operations to be carried out. They are described in order below:

- 1) **Changing the number of registers monitored:** This step consists of changing the value of “Number of registers” element of the “Query” from the “Read Holding Registers” command (Modbus command for reading the values of a number of registers). Select this element, then change its value as shown below. ABC-LUFP Config Tool will automatically convert any value entered in decimal to hexadecimal.

The screenshot shows the ABC-LUFP Config Tool interface. The main window is titled "ABC-LUFP - Master Mode - LUFP7 (tutorial)". The left pane shows a tree view of the configuration, with "Number of registers" selected under the "Query" node. The right pane shows the configuration details for "Number of registers", with the "Value" field set to "0x0001". A red arrow points from this field to a zoomed-in view of the configuration dialog, where the "Value" field is set to "8". A second red arrow points down to another zoomed-in view of the configuration dialog, where the "Value" field is set to "0x0008".

- 2) **Changing the number of data bytes in the Modbus response:** The number of bytes read from the “TeSys U n°2” motor starter memory increases from 2 to 16, as the number of registers monitored has increased from 1 to 8. Select the “Byte count” element from the “Response” and change its value as shown below. ABC-LUFP Config Tool will automatically convert any value entered in decimal to hexadecimal.

The screenshot shows the ABC-LUFP Config Tool interface. The main window is titled "ABC-LUFP - Master Mode - LUFP7 (tutorial)". The left pane shows a tree view of the configuration, with "Byte count" selected under the "Response" node. The right pane shows the configuration details for "Byte count", with the "Value" field set to "0x02". A red arrow points from this field to a zoomed-in view of the configuration dialog, where the "Value" field is set to "16". A second red arrow points down to another zoomed-in view of the configuration dialog, where the "Value" field is set to "0x10".

6. Configuring the Gateway

- 3) Changing the location of the Modbus data received in the gateway's memory: As the number of bytes read (see previous step) has increased from 2 to 16, the Modbus data received must be placed at a different location in the gateway's memory, and the size of the memory occupied must also be adjusted appropriately.

If you are not certain how much of the gateway's memory is currently occupied, select "Sub-Network" and choose "Monitor" from the "Sub-Network" menu. The following window appears, allowing you to see how much of the gateway's memory is occupied.

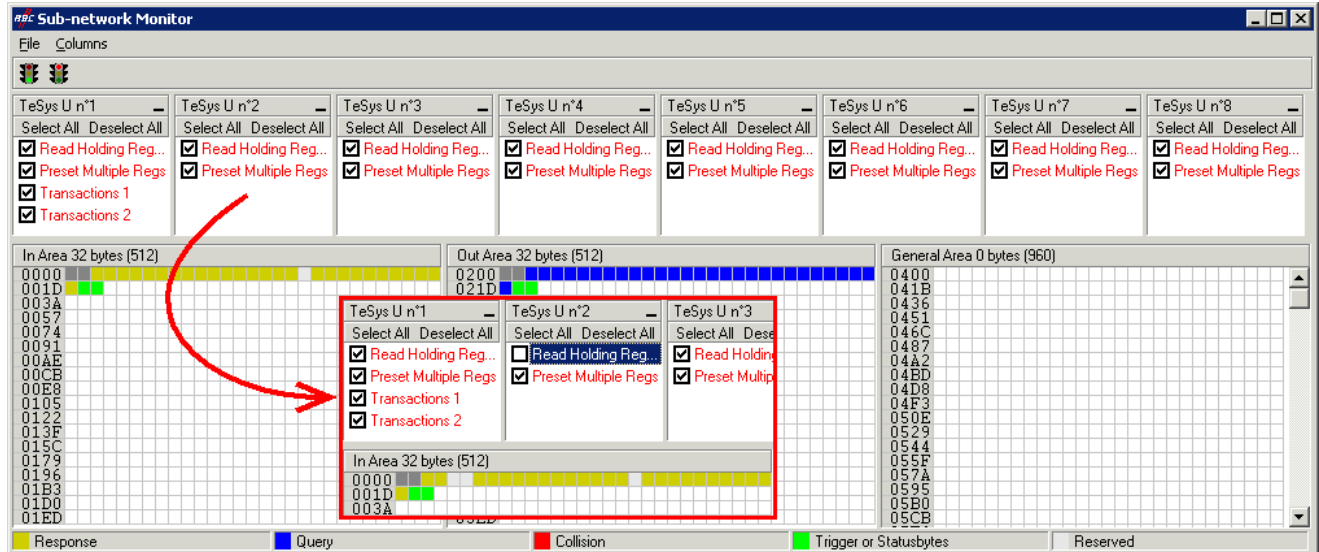

To see which memory locations are occupied by data from the command you are interested in, uncheck the box corresponding to the "Read Holding Registers" command from the "TeSys U n°2" node, as shown above. We can see that the Modbus data received in response to this command occupy 2 bytes located from address 0x0004.

NOTE:

- The memory locations 0x0000 and 0x0001 are reserved (see chapter 5). So you will not be able to place any Modbus data in these locations.
- The sizes displayed above the graphics areas of this window ("In Area 32 bytes" and "Out Area 32 bytes") correspond to the total input and output sizes you must configure using the modules presented under SyCon (see point 6).

You may wish to place the 16 bytes of Modbus data which will be received by the gateway for this command into memory once you have made the changes. There are two methods:

- 1) Move all the other data by 14 bytes – which may be a tedious process
- 2) Change the memory location of the block of data received.

The first solution is preferable as it avoids leaving any "holes" in the gateway's memory, thus optimising the transfer of all data to the Profibus-DP master PLC. The TSX PB5 100 coupler may exchange up to 242 input words with Profibus-DP slaves. If communication with a larger number of slaves is required, limit the volume of exchanges with the LUF7 gateway. In that case, leaving such "blanks" in the gateway memory is not advisable.

For this example, we will use the second method and place the 16 bytes of data from address 0x0020 (32 in decimal). This is directly after the input data for the gateway's default configuration.

6. Configuring the Gateway

Close the “Sub-network Monitor” window, then once you are back in the main ABC-LUFP Config Tool window, select the “Data length” and “Data location” fields of the “Data” element from the “Response” one after another and change their values as shown below. ABC-LUFP Config Tool will automatically convert any value entered in decimal to hexadecimal.

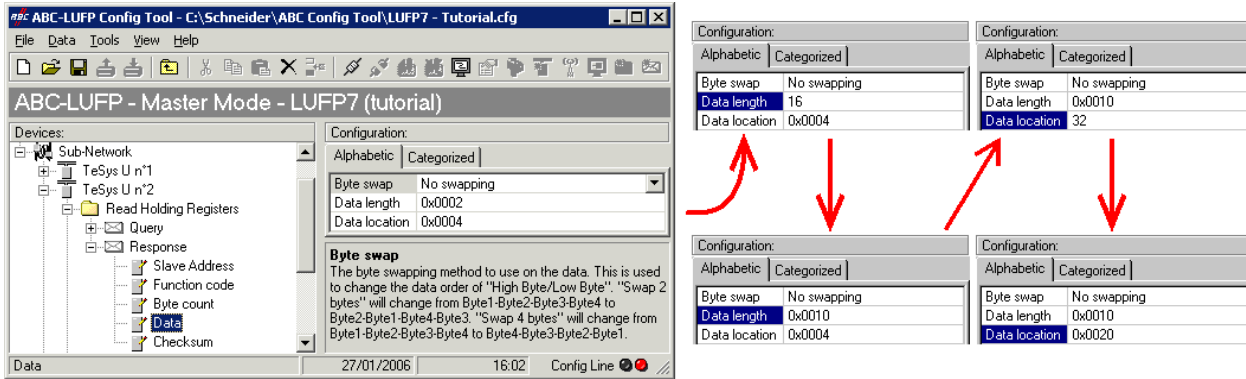

To check that these changes have been entered into the configuration, choose “Monitor” from the “Sub-Network” menu again:

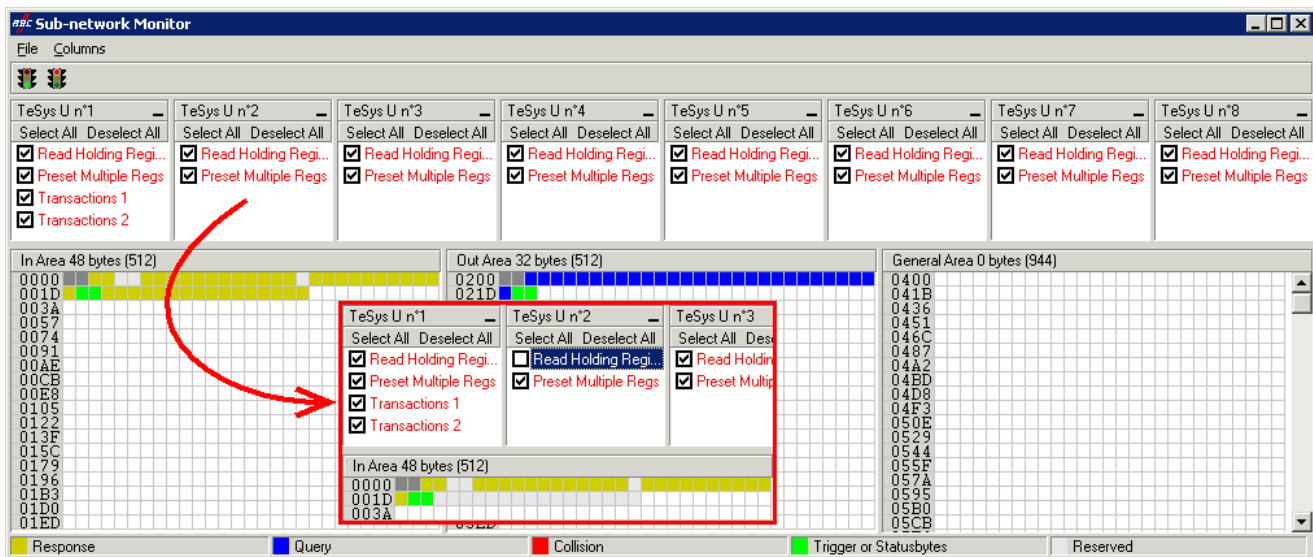

- 4) **Transferring this configuration to the gateway:** Please see chapter **Erreur ! Source du renvoi introuvable..** Check that the configuration is valid (LED 6 GATEWAY flashing green). However, the gateway configuration is now different from the one taken into account by the Profibus-DP coupler with respect to the gateway (difference in the total length of input data), the LED 4 FIELDBUS DIAG therefore becomes flashing red at a frequency of 1 Hz, providing that the gateway is connected to the Profibus-DP network and to its DPM1 master.
- 5) **Saving this configuration to your PC's hard disk:** See chapter 4.2.7.

6. Configuring the Gateway

- 6) Changing the amount of data received by the Profibus-DP coupler: Under SyCon, change the list of modules configured for the gateway (see chapter 4.2.6). Since we have added 16 bytes after the input data in the gateway memory, the coupler should be configured to receive a block of input data with 16 bytes more from the gateway.

In this case, add an "INPUT: 16 Byte (8 word)" module after the module configured for the gateway, as the number of input bytes in the default configuration is even (word-aligned).

Slot	Idx	Module	Symbol	Type	I Addr.	I	Type	Q Addr.	Q
1	1	IN/OUT: 32 Byte	Module1	IW	0	16	QW	0	16
2	1	INPUT: 16 Byte	Module2	IW	16	8			

Then you should save and export the configuration of the Profibus-DP network, as described in chapter 4.2.7.

- 7) Configuring the Profibus-DP master PLC inputs: under PL7 PRO, import the new configuration of the Profibus-DP network (see chapter 4.2.8 and following chapters). Words %IW4.0.16 to %IW4.0.23 are now displayed in the "PROFIBUS-DP slave data" frame of the TSX PBY 100 coupler configuration window.

6. Configuring the Gateway

We get a correspondence derived from the one used for the gateway default configuration. The changes in relation to the default configuration are shown by a greyed-out background, like the “free memory locations”.

Service	PLC input	Description	
		Bit 15.....Bit 8	Bit 7.....Bit 0
Managing the downstream Modbus network	%IW4.0	Gateway status word	
Periodic communications — Monitoring of TeSys U motor starters	%IW4.0.1	Value of the motor starter ① status register	
	%IW4.0.2	Free memory location	
	%IW4.0.3	Value of the motor starter ③ status register	
	%IW4.0.4	Value of the motor starter ④ status register	
	%IW4.0.5	Value of the motor starter ⑤ status register	
	%IW4.0.6	Value of the motor starter ⑥ status register	
	%IW4.0.7	Value of the motor starter ⑦ status register	
	%IW4.0.8	Value of the motor starter ⑧ status register	
Aperiodic communications — Reading the value of a motor starter parameter (RESPONSE)	%IW4.0.9	Free memory location	Slave no. (0x01-0x08)
	%IW4.0.10	Function number (0x03)	Number of bytes read (0x02)
	%IW4.0.11	Value of the parameter read (0xxxxx)	
Aperiodic communications — Writing the value of a motor starter parameter (RESPONSE)	%IW4.0.12	Slave number (0x01 to 0x08)	Function number (0x06)
	%IW4.0.13	Address of the parameter written (0xxxxx)	
	%IW4.0.14	Value of the parameter written (0xxxxx)	
Aperiodic communications (“Trigger bytes” for the responses)	%IW4.0.15	Read parameter response counter	Write parameter response counter
Periodic communications — Monitoring of TeSys U motor starter ②	%IW4.0.16	Value of the “TeSys U Status Register”	
	%IW4.0.17	Value of the “Complementary Status Register”	
	%IW4.0.18	Value of the “K7 Status Register”	
	%IW4.0.19	Value of the “K7 Status Register 2 (free format)”	
	%IW4.0.20	Value of the “K7 Status Register 3 (free format)”	
	%IW4.0.21	Value of the “Warning Number” register	
	%IW4.0.22	Value of the “Warning Register”	
%IW4.0.23	Value of the “Reserved : 2nd Warning Register”		

- 8) Transferring the Profibus-DP coupler configuration: Once changes have been made to the Profibus-DP coupler configuration, it is necessary to validate the hardware configuration of the PLC rack, and to transfer the whole application to the Premium PLC on which the coupler is located. Please see chapter 4.2.12.

6. Configuring the Gateway

6.9.4. Increasing the Amount of Periodic Output Data

We will use the node corresponding to “TeSys U n°4” motor starter for our example. By default, we are controlling Command Register 704. To add control of Command Register 705, we will carry out the following operations.

- 1) Changing the number of registers controlled: This step consists of changing the value of the “Number of registers” in the “Query” and the one for the “Preset Multiple Registers” command (Modbus command for writing values of a number of registers) in the “Response”. Start by selecting “N° of Registers” from the “Query”, then change its value as shown below. ABC-LUFP Config Tool will automatically convert any value entered in decimal to hexadecimal. Do the same for the “N° of Registers” element of the “Response” because the gateway checks the value of this field when it receives each Modbus response. If the value does not correspond to that of the query, the gateway will ignore the response.

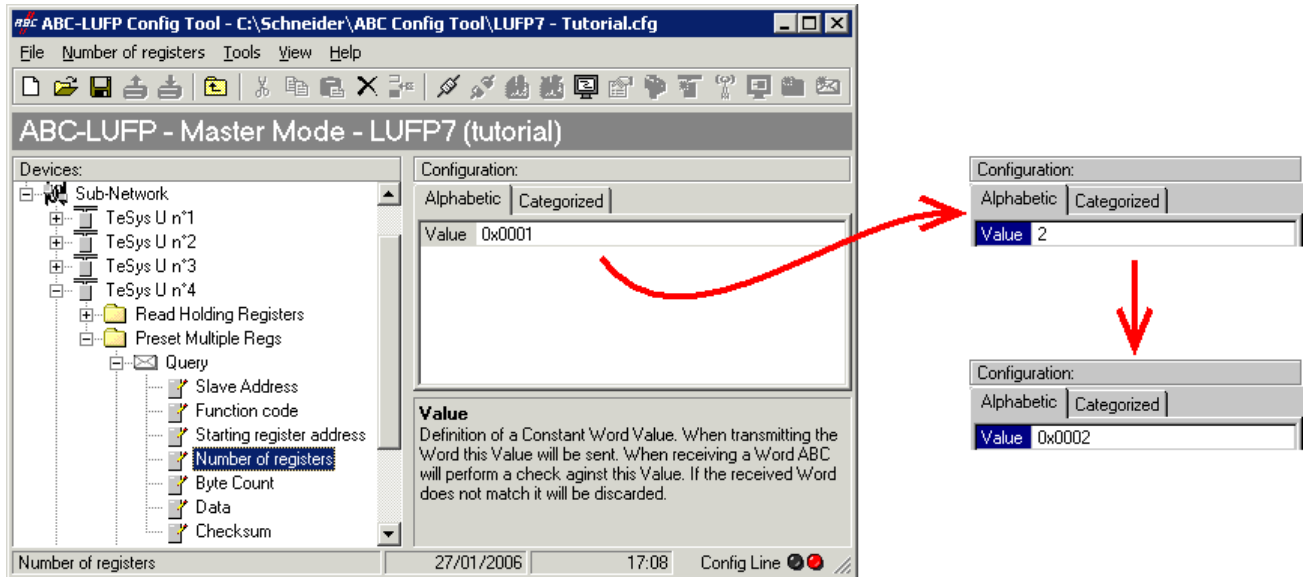

- 2) Changing the number of data bytes in the Modbus query: The number of bytes written into the memory of the “TeSys U n°4” motor starter memory increases from 2 to 4, as the number of registers controlled has increased from 1 to 2. Select the “Byte count” element from the “Query” and change its value as shown below. ABC-LUFP Config Tool will automatically convert any value entered in decimal to hexadecimal.

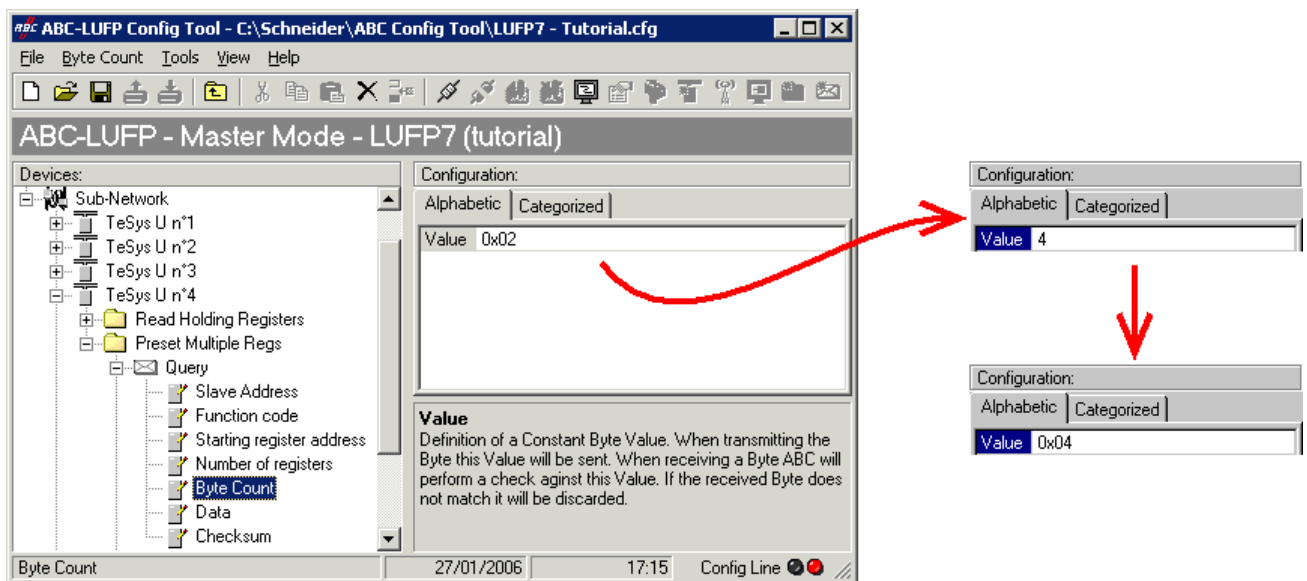

6. Configuring the Gateway

- 3) Changing the location of the Modbus data transmitted into the gateway's memory: As the number of bytes written (see previous step) has increased from 2 to 4, the Modbus data to be transmitted to the "TeSys U n°4" motor starter must be placed at a different location in the gateway's memory, and the size of the memory occupied must also be adjusted appropriately.

If you are not certain how much of the gateway's memory is currently occupied, select "Sub-Network" and choose "Monitor" from the "Sub-Network" menu. The window shown below appears, allowing you to see how much of the gateway's memory is occupied.

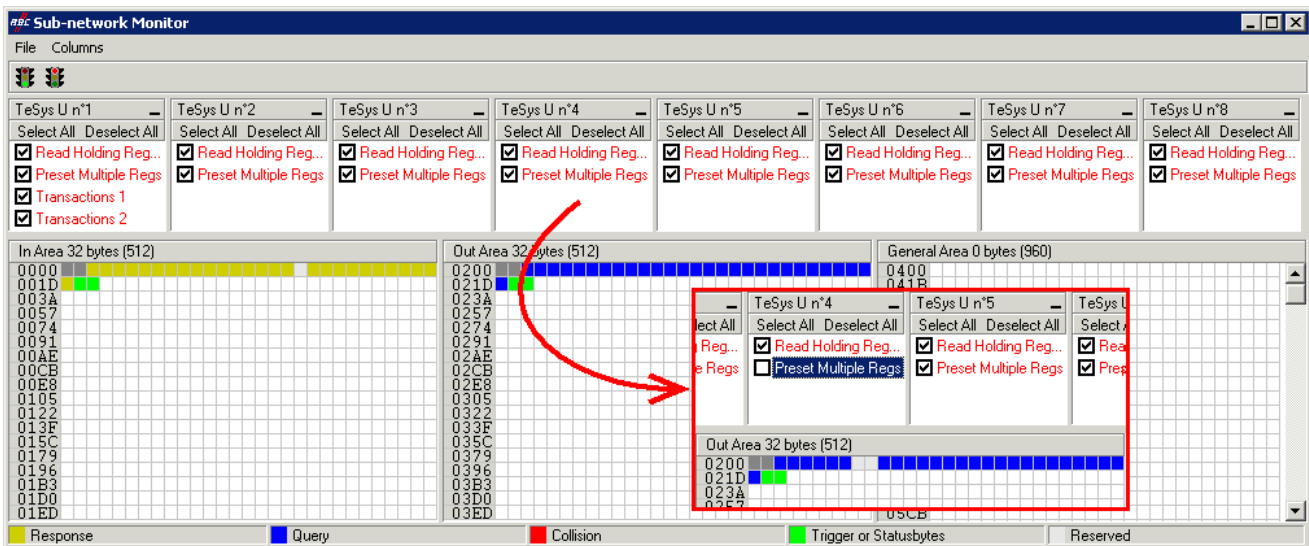

To see which memory locations are occupied by data from the command you are interested in, uncheck the box corresponding to the "Preset Multiple Registers" command from the "TeSys U n°4" node, as shown above. We can see that the Modbus data transmitted with the query corresponding to this command occupy 2 bytes located from address 0x0208.

NOTE:

- Memory locations 0x0200 and 0x0201 are reserved (see chapter 5). So you will not be able to place any Modbus data in these locations.
- The sizes displayed above the graphics areas of this window ("In Area 32 bytes" and "Out Area 32 bytes") correspond to the total input and output sizes you must configure using the modules presented under SyCon (see point 6).

You may wish to place the 4 bytes of Modbus data which will be transmitted by the gateway for this command into memory, once the changes have been made. There are two methods:

- 1) Move all the other output data by 2 bytes – which may be a tedious process
- 2) Change the memory location of the block of data transmitted.

The first solution is preferable as it avoids leaving any "holes" in the gateway's memory, thus optimising the transfer of all of the data from the Profibus-DP master PLC. The TSX PBY 100 coupler can exchange up to 242 output words with Profibus-DP slaves. If communication with a larger number of slaves is required, limit the volume of exchanges with the LUF7 gateway. In that case, leaving such "blanks" in the gateway memory is not advisable.

For this example, we will use the second method. This is directly after the input data for the gateway's default configuration.

When selecting a value for the "Data Location" field, data must be located at even addresses in order to align the Modbus data (in 16-bit format) on the %QW4.0.x outputs of the Profibus-DP TSX PBY 100 coupler.

6. Configuring the Gateway

⚠ WARNING

RISK OF UNINTENDED EQUIPMENT OPERATION

The user must use even values for the “Data Location” field. The selection of odd data values complicates application programming and increases the likelihood of improper Modbus values being written to or read from the slave devices. Depending on the user’s configuration, unintended equipment operation may result.

Failure to follow this instruction can result in death, serious injury, or equipment damage.

Returning to our previous example, we will place the 4 bytes of data from address 0x0220 (544 in decimal).

Close the “Sub-network Monitor” window, then once you are back in the main ABC-LUFP Config Tool window, select the “Data length” and “Data location” fields of the “Data” element from the “Query” one after another and change their values as shown below. ABC-LUFP Config Tool will automatically convert any value entered in decimal to hexadecimal.

The screenshot shows the ABC-LUFP Config Tool interface. The main window displays the configuration for the 'Data' element under the 'Query' menu. The configuration fields are:

- Byte swap: No swapping
- Data length: 0x0002
- Data location: 0x0208

Four inset windows show the configuration changes being made:

- Top-left: Data length is 4, Data location is 0x0208.
- Top-right: Data length is 0x0004, Data location is 544.
- Bottom-left: Data length is 0x0004, Data location is 0x0208.
- Bottom-right: Data length is 0x0004, Data location is 0x0220.

Red arrows indicate the sequence of changes: from the top-left to the top-right, then to the bottom-left, and finally to the bottom-right.

To check that these changes have been entered into the configuration, choose “Monitor” from the “Sub-Network” menu again:

The screenshot shows the ABC Sub-network Monitor interface. The main window displays the configuration for the 'TeSys U n4' device. The configuration fields are:

- Select All: [x]
- Deselect All: [x]
- Read Holding Reg...: [x]
- Preset Multiple Regs: [x]
- Transactions 1: [x]
- Transactions 2: [x]

The monitor shows the data area for TeSys U n4 (Out Area 36 bytes [512]) and the General Area 0 bytes (956). The data area is highlighted in blue, and the General Area is highlighted in yellow. A red arrow points to the configuration fields for TeSys U n4.

6. Configuring the Gateway

- 4) Transferring this configuration to the gateway: Please see chapter **Erreur! Source du renvoi introuvable..** Check that the configuration is valid (LED ⑥ GATEWAY flashing green). However, the gateway configuration is now different from the one taken into account by the Profibus-DP coupler with respect to the gateway (difference in the total length of input data), the LED ④ FIELDBUS DIAG therefore becomes flashing red at a frequency of 1 Hz, providing that the gateway is connected to the Profibus-DP network and to its DPM1 master.
- 5) Saving this configuration to your PC's hard disk, see chapter 4.2.7.
- 6) Changing the number of data transmitted by the Profibus-DP coupler: Under SyCon, change the list of modules configured for the gateway (see chapter 4.2.6). Since we have added 4 bytes after the output data in the gateway memory, the coupler should be configured to issue an additional 4-byte output data block for the gateway.

In this case, add an "INPUT: 4 Byte (2 word)" module after the module configured for the gateway, as the number of input bytes in the default configuration is even (word-aligned).

<p>NOTE: Make sure that the total input and output sizes of the configured modules are the same as the exchange sizes displayed in the "Sub-network Monitor." In the current example, "In Area 32 bytes" and "Out Area 36 bytes" imply that the modules combined under SyCon must have a total of 16 IW and 18 OW.</p>

6. Configuring the Gateway

In this example, the modules configured for the gateway are listed on the right.

Slot	Idx	Module	Symbol	Type	I Addr.	I	Type	O Addr.	O
1	1	IN/OUT: 32 Byte	Module1	IW	0	16	QW	0	16
2	1	OUTPUT: 4 Byte	Module2				QW	16	2

Then you should save and export the configuration of the Profibus-DP network, as described in chapter 4.2.7.

- 7) Configuring the Profibus-DP master PLC outputs: under PL7 PRO, import the new configuration of the Profibus-DP network (see chapter 4.2.8). Words %QW4.0.16 and %QW4.0.17 are now displayed in the "PROFIBUS-DP slave data" frame of the TSX PBY 100 coupler configuration window, providing that the address 2 station is selected in the list of the "PROFIBUS-DP slave configuration" frame.

We get a correspondence derived from the one used for the gateway default configuration. The changes in relation to the default configuration are shown by a greyed-out background, like the "free memory locations".

Service	PLC output	Description	
		Bit 15	Bit 8 Bit 7
Managing the downstream Modbus network	%QW4.0	Profibus-DP master command word	
Periodic communications — Controlling TeSys U motor starters	%QW4.0.1	Value of the motor starter ① command register	
	%QW4.0.2	Value of the motor starter ② command register	
	%QW4.0.3	Value of the motor starter ③ command register	
	%QW4.0.4	Free memory location	
	%QW4.0.5	Value of the motor starter ⑤ command register	
	%QW4.0.6	Value of the motor starter ⑥ command register	
	%QW4.0.7	Value of the motor starter ⑦ command register	
	%QW4.0.8	Value of the motor starter ⑧ command register	
Aperiodic communications — Reading the value of a motor starter parameter (QUERY)	%QW4.0.9	Slave number (0x01-0x08)	Function number (0x03)
	%QW4.0.10	Address of the parameter to be read (0xxxxx)	
	%QW4.0.11	Number of parameters to be read (0x0001)	
Aperiodic communications — Writing the value of a motor starter parameter (QUERY)	%QW4.0.12	Slave number (0x01-0x08)	Function number (0x06)
	%QW4.0.13	Address of the parameter to be written (0xxxxx)	
	%QW4.0.14	Value of the parameter to be written (0xxxxx)	
Aperiodic communications ("Trigger bytes" for the queries)	%QW4.0.15	Read parameter query counter	Write parameter query counter
Periodic communications — Controlling motor starter TeSys U ④	%QW4.0.16	Value of the "Command Register"	
	%QW4.0.17	Value of the "2nd Command Register"	

- 8) Transferring the Profibus-DP coupler configuration: Once changes have been made to the Profibus-DP coupler configuration, it is necessary to validate the hardware configuration of the PLC rack, and to transfer the whole application to the Premium PLC on which the coupler is located. Please see chapter 4.2.12.

6. Configuring the Gateway

6.10. Deleting Aperiodic Parameter Data

If your PLC application does not need the aperiodic service for reading/writing parameter data on Modbus slaves, you can delete the associated commands. If you also intend to add Modbus data, and therefore use new locations in the gateway's memory, it is preferable to delete the aperiodic commands from the start, so that you can reuse the memory locations.

On the other hand, if the only configuration operation you wish to carry out on the LUFFP7 gateway consists of not using the aperiodic service for parameter data, you can simply not use this service. Go straight on to step 8.

If you decide to delete the aperiodic commands, you will need to carry out the following operations:

- 1) Displaying parameter data commands: Select the very first node of the downstream Modbus network, "TeSys U n°1", and expand the tree structure showing its commands and transactions. The screen should look like the one below.

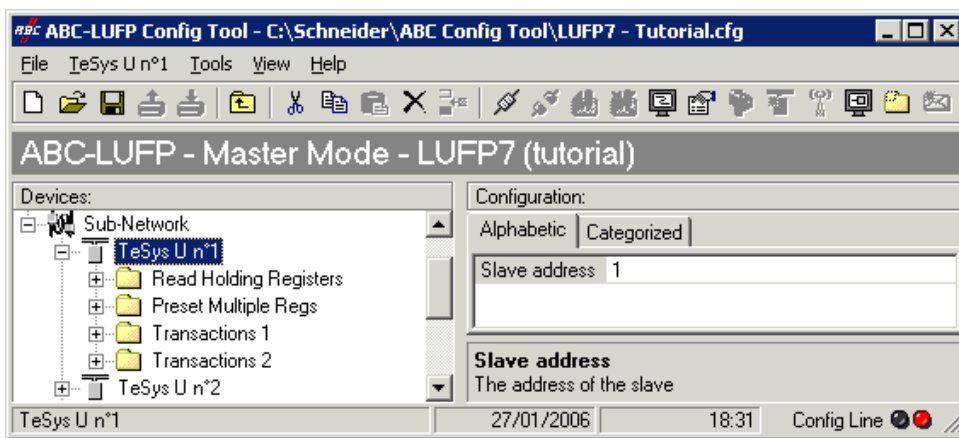

- 2) Deleting the read command for a parameter: Select the personalized "Transactions 1" command and delete it with the "De1" key (or "Delete" from the menu whose name corresponds to the name of the selected node). A request for confirmation appears, asking you whether or not to proceed deleting the "Transactions 1" command. In this case confirm with the "Yes" button.

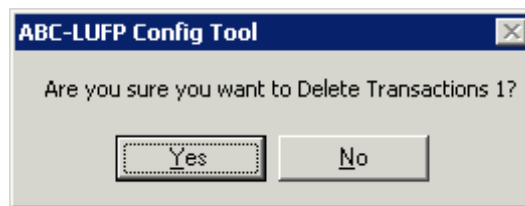

- 3) Deleting the write command for a parameter: Back in the main ABC-LUFFP Config Tool window, the "Transactions 1" command has been deleted. The second personalised command, "Transactions 2" is automatically renamed "Transactions 1", but retains all of its setup. Now delete this one in the same way as you did with the previous command.

6. Configuring the Gateway

- 4) Checking the new memory occupation: If you wish to check how much of the gateway's memory is now occupied, select "Sub-Network" and choose "Monitor" from the "Sub-Network" menu. The following window appears, allowing you to see how much of the gateway's memory is occupied by Modbus data. The part framed in red represents the memory occupation before the deletion of the two setup commands. It has been inlaid in the illustration below so that you can see the effects of the deletion operations we have just carried out.

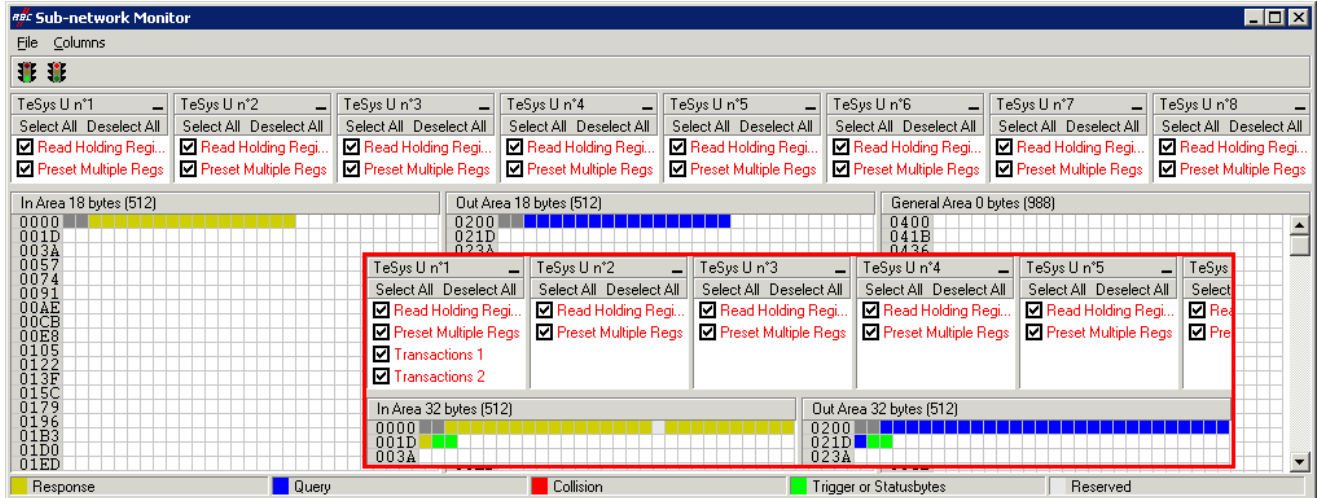

You will note that the "TeSys U n°1" section now only has the two Modbus commands common to the eight TeSys U motor starters, and that the memory locations which corresponded to the two personalised commands are now free.

NOTE: The free memory location at address 0x0012 in the gateway's memory is no longer part of the gateway's inputs, because there is no input data used beyond this address.

- 5) Transferring this configuration to the gateway: Please see chapter **Erreur ! Source du renvoi introuvable..** Check that the configuration is valid (LED  GATEWAY flashing green).
- 6) Saving this configuration to your PC's hard disk.
- 7) Changing the amount of data received and the number of data transmitted by the Profibus-DP coupler: Still in SyCon, change the list of modules configured for the gateway (see chapter 4.2.6). Since now you only have 18 input data bytes and 18 output data bytes in the gateway memory, the coupler should be configured to receive an 18-byte input data block from the gateway and to transfer an 18-byte output data block to the gateway.

Slot	Idx	Module	Symbol	Type	I Adr.	I Len.	Type	O Addr.	O Len.
1	1	IN/OUT: 2 Byte (1 word)	Module1	I/W	0	1	O/W	0	1
2	1	IN/OUT: 16 Byte (8 word)	Module2	I/W	1	8	O/W	1	8

Then you should save and export the configuration of the Profibus-DP network, as described in chapter 4.2.7.

6. Configuring the Gateway

- 8) Configuring the inputs and outputs of the Profibus-DP master PLC: under PL7 PRO, import the new configuration of the Profibus-DP network (see chapter 4.2.8 and following chapters). Only words %IW4.0 to %IW4.0.8 and %QW4.0 to %QW4.0.8 are now displayed in the "PROFIBUS-DP slave data" frame of the TSX PB5 100 coupler configuration window, providing that the address 2 station is selected in the list of the "PROFIBUS-DP slave configuration" frame.

We get the two correspondences represented below, derived from the ones used for the gateway default configuration.

Service	PLC input	Description			
		Bit 15.....	Bit 8	Bit 7.....	Bit 0
Managing the downstream Modbus network	%IW4.0	Gateway status word			
Periodic communications — Monitoring of TeSys U motor starters	%IW4.0.1	Value of the motor starter ① status register			
	%IW4.0.2	Value of the motor starter ② status register			
	%IW4.0.3	Value of the motor starter ③ status register			
	%IW4.0.4	Value of the motor starter ④ status register			
	%IW4.0.5	Value of the motor starter ⑤ status register			
	%IW4.0.6	Value of the motor starter ⑥ status register			
	%IW4.0.7	Value of the motor starter ⑦ status register			
	%IW4.0.8	Value of the motor starter ⑧ status register			

Service	PLC output	Description			
		Bit 15.....	Bit 8	Bit 7.....	Bit 0
Managing the downstream Modbus network	%QW4.0	Profibus-DP master command word			
Periodic communications — Controlling TeSys U motor starters	%QW4.0.1	Value of the motor starter ① command register			
	%QW4.0.2	Value of the motor starter ② command register			
	%QW4.0.3	Value of the motor starter ③ command register			
	%QW4.0.4	Value of the motor starter ④ command register			
	%QW4.0.5	Value of the motor starter ⑤ command register			
	%QW4.0.6	Value of the motor starter ⑥ command register			
	%QW4.0.7	Value of the motor starter ⑦ command register			
	%QW4.0.8	Value of the motor starter ⑧ command register			

- 9) Transferring the Profibus-DP coupler configuration: Once changes have been made to the Profibus-DP coupler configuration, it is necessary to validate the hardware configuration of the PLC rack, and to transfer the whole application to the Premium PLC on which the coupler is located. Please see chapter 4.2.12.

6.11. Changing a Modbus Slave Configuration

Configuring a Modbus slave itself remains very simple because it only involves the name and the Modbus address of the node to which it corresponds. On the contrary, configuring Modbus commands is much more complete and is the subject of a separate object of its own (see chapter 6.12).

You will need to change the configuration of a Modbus slave when you add a new Modbus unit (see chapter 6.8), using any method.

Changing the name of the node which corresponds to a Modbus slave is used to distinguish it from the other nodes when the configuration of its Modbus commands has been changed, for instance.

6. Configuring the Gateway

6.11.1. Changing the Name of a Modbus Slave

To carry out this operation, select the node which corresponds to the Modbus slave involved (“Devices:” section), and perform one of the four following actions:

- right-click on the node and click on “Rename” in the popup menu that appears, **or**
- select the node and click on the node's name, **or**
- select the node and choose “Rename” in the menu whose name matches the node's name, **or**
- use the F2 function key.

After confirming the new name (“Enter” key or click outside the node's name), it will be used to update the menu bar and the status bar of ABC-LUFP Config Tool. An example is given below. The three red frames shown in this example show the consequences of the change made.

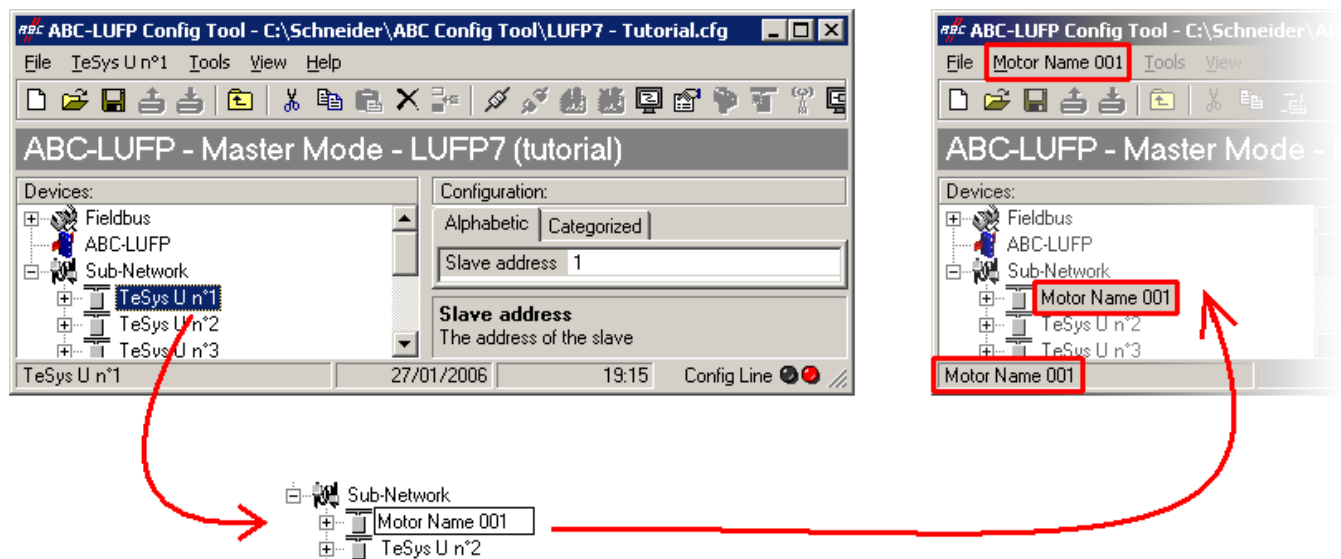

6.11.2. Changing the Address of a Modbus slave

To carry out this operation, select the node which corresponds to the Modbus slave involved (“Devices:” section), click on the value of the current address (value of the “Slave address” field, in the “Configuration:” section), then change it.

NOTE: The address of a Modbus slave must be between 1 and 247. The system will not let you add a value > 247.

⚠ WARNING

USE OF RESERVED MODBUS ADDRESSES

Do not use Modbus addresses 65, 126, or 127 if a gateway's Modbus slaves will include a Schneider Electric Adjustable-Speed Drive System device such as an Altistart soft-starter or an Altivar motor drive. The Altistart and Altivar devices reserve these addresses for other communications, and the use of these addresses in such a system can have unintended consequences.

Failure to follow this instruction can result in death, serious injury, or equipment damage.

6. Configuring the Gateway

After confirming the new address (“Enter” key or click outside the data entry field of the address of the Modbus slave), this will become effective in ABC-LUFP Config Tool, and the values of the “Slave Address” elements of the queries and responses in the Modbus commands for the selected node will be automatically updated. An example is given below, but the updating of a single “Slave Address” element is shown:

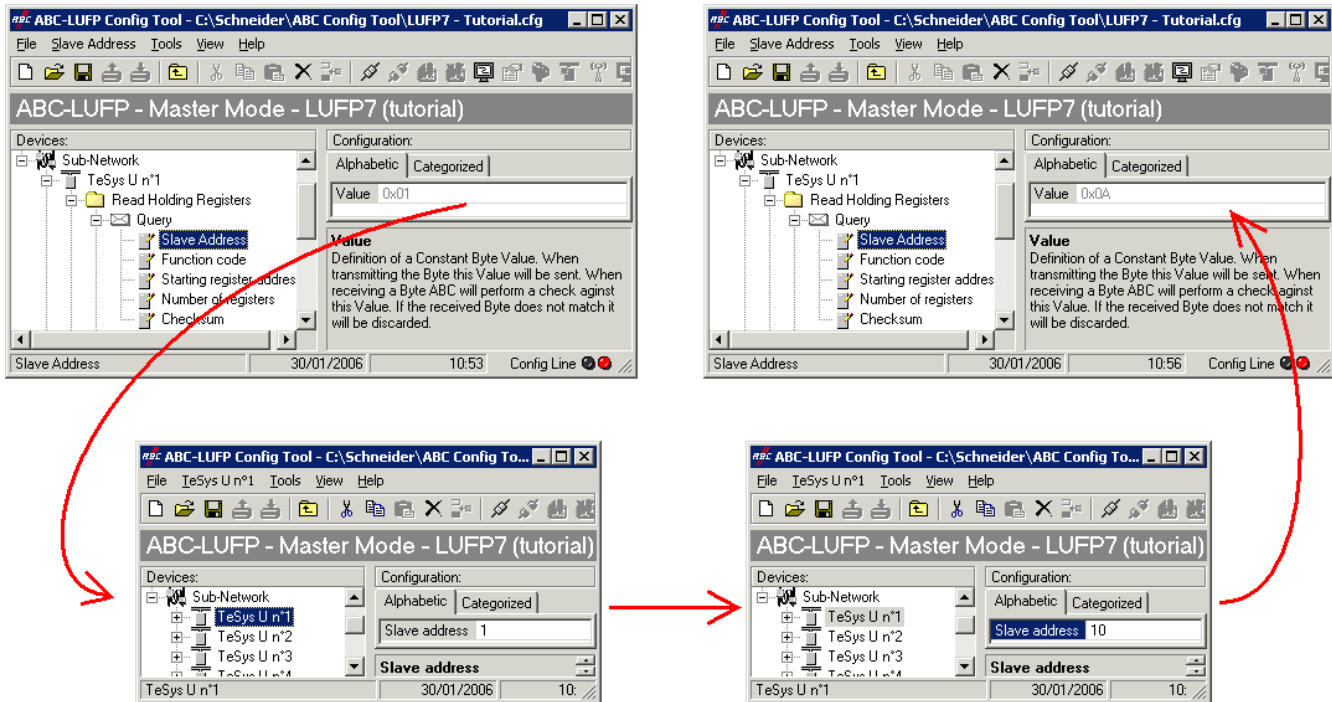

6.11.3. Changing the Name of a Modbus Command or Transaction

To rename a Modbus Command or Transaction, first perform one of the following actions:

- right-click on the name of the command itself (e.g. Preset Multiple Regs) and click on “Rename” in the popup menu that appears, **or**
- select the name of the command and choose “Rename” in its corresponding menu, **or**
- select the name of the command and click inside its name, **or**
- select the name of the command and press the F2 key.

Then, type the new name of the command, and confirm it (“Enter” key or click outside the name’s field) or cancel it (“Escape” key). Once confirmed, the new name will become effective in ABC-LUFP Config Tool.

6. Configuring the Gateway

For Modbus commands, but not Transactions, the type of command is automatically appended at the end of its new name.

An example is given below:

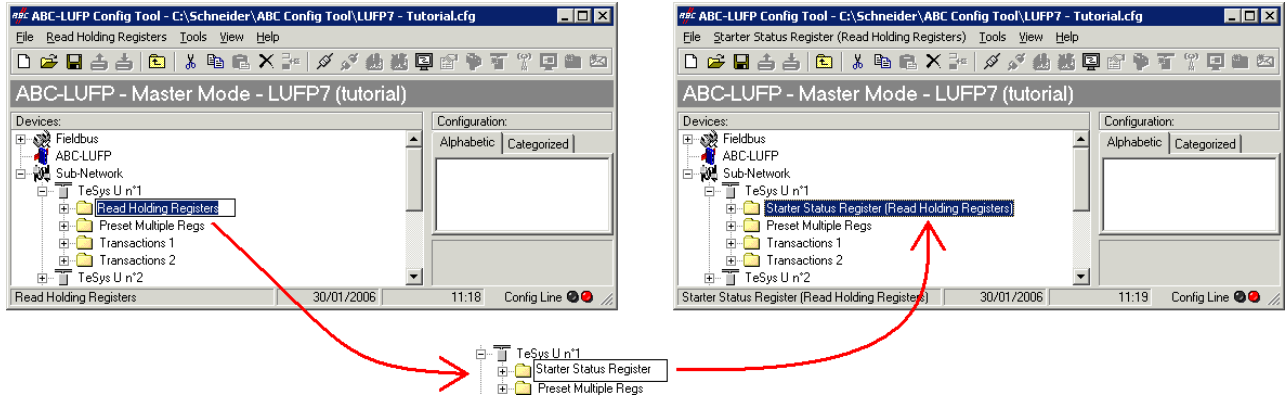

This renaming function can also be used for the Queries and Responses of the Modbus Commands and Transactions, as illustrated by the following example:

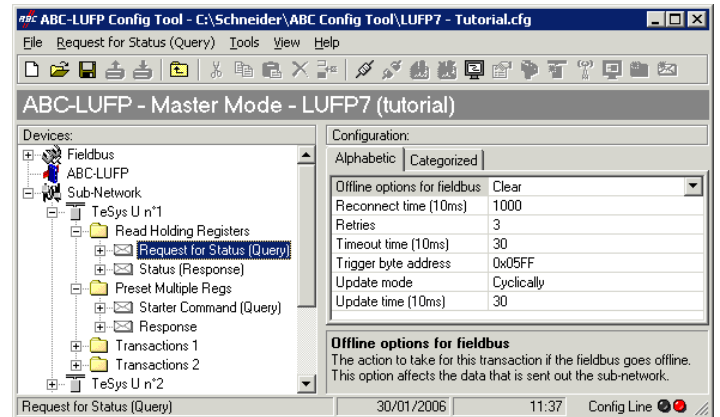

6.12. Adding and Setting Up a Modbus Command

6.12.1. With the TeSys U Motor Starters

With TeSys U motor starters, the main use of adding a Modbus command allows you to control or monitor additional registers, without having to change the elements in the default configuration. So, the operation of the periodic and aperiodic communication services remains the same as for the default configuration, unlike the operations described in the various parts of chapter 6.9.

Instead of adding a command and fully configuring it, it is a better idea to copy one of the two default commands for TeSys U motor starters, "Read Holding Registers" (reading/monitoring) or "Preset Multiple Registers" (writing/controlling), and to paste it into the list of Modbus commands for the appropriate node.

6. Configuring the Gateway

To copy an already configured Modbus command, select it, then choose “Copy” from the menu whose name corresponds to the name of the selected command. **Keyboard shortcut:** “Ctrl C”. Then continue using one of the two methods shown below:

- a) Select the node corresponding to the Modbus slave for which you wish to add this command (e.g. “TeSys Un°4”), then choose “Paste” from the menu whose name corresponds to the selected node. A new command is added after all the other configured commands for this node. The whole of its configuration is identical to that for the previously copied command. **Keyboard shortcut:** “Ctrl V”.
- b) Select one of the commands for the node involved, then choose “Insert” from the menu whose name corresponds to the selected command. A new command is added just before the one which is selected. The whole of its configuration is identical to that for the previously copied command.

As the new Modbus command and the original Modbus command are identical, you will need to make changes to the fields **highlighted in blue** in one of the two diagrams below, depending on whether this is the “Preset Multiple Regs” command or a “Read Holding Registers” command (see chapter 6.9). The correspondence between the various elements which appear in these tree structures and the standard Modbus terminology is located to their right:

6. Configuring the Gateway

Pre-set Multiple Regs

Name of the Modbus command	Modbus query	Frame
Slave Address	Slave no.	
Function code	Function no.	
Starting register address	No. of the 1st word (MSB / LSB)	
Number of registers	Number of words (MSB / LSB)	
Byte Count	Number of bytes	
Data	...Values of the words (MSB/LSB)...	
Checksum	CRC16 (LSB / MSB)	
Modbus response		
Slave Address	Slave no.	
Function code	Function no.	
Starting register address	No. of the 1st word (MSB / LSB)	
Number of registers	Number of words (MSB / LSB)	
Checksum	CRC16 (LSB / MSB)	

Alphabetic | Categorized

Byte swap	No swapping
Data length	0x0002
Data location	0x0204

Read Holding Registers

Name of the Modbus command	Modbus query	Frame
Slave Address	Slave no.	
Function code	Function no.	
Starting register address	No. of the 1st word (MSB / LSB)	
Number of registers	Number of words (MSB / LSB)	
Checksum	CRC16 (LSB / MSB)	
Modbus response		
Slave Address	Slave no.	
Function code	Function no.	
Byte count	Number of bytes read	
Data	...Values of the words (MSB/LSB)...	
Checksum	CRC16 (LSB / MSB)	

Alphabetic | Categorized

Byte swap	No swapping
Data length	0x0002
Data location	0x0004

NOTE: In all cases, the “Query / Slave Address” and “Response / Slave Address” elements are automatically updated by ABC-LUFP Config Tool according to the node in which the command is located. Their values cannot be changed by the user. In the same way, the “Query / Function code” and “Response / Function code” fields depend on the nature of the Modbus command and cannot be changed by the user.

6. Configuring the Gateway

The operations to be carried out are similar to changing the default commands. For the “Read Holding Registers” command, please see chapter 6.9.1, and chapter 6.9.3. For the “Preset Multiple Regs” command, please see chapter 6.9.2, and chapter 6.9.4.

6.12.2. With a Generic Modbus Slave

In this chapter, we will add and configure Modbus commands differing from the LUFFP7 defaults.

Please see Appendix F: Modbus Commands, for a list of the Modbus functions supported by the LUFFP7 gateway. If you need to use a command which is not supported by the gateway, you can configure one. A command of this sort is included in a specific element called “Transactions” or becomes a new Modbus command in its own right. Please see the next paragraph for further details on this subject.

For our example, we will use an Altistart starter, the ATS48, and a Modbus command recognized both by the gateway and the ATS48. This is the “Preset Single Register” command, whose function code is 6 and which allows you to write the value of a unique output word. This function will be used to periodically write the value of the ATS48’s CMD command register, located at address W400 (address 400 = 0x0190).

Since the gateway’s default configuration already has 8 Modbus slaves, you will need to delete one of them, such as the “TeSys U n°2” node, for example, and to add a new node in its place (see chapter 6.7 and chapter 6.8).

NOTE: We strongly advise you not to delete the “TeSys U n°1” node, as it contains the commands corresponding to the read and write services for a parameter in a Modbus slave.

After creating the new node, we rename it and assign it Modbus address 10, as shown at right:

We then add the “Preset Single Register” command by choosing “Add Command” from the “ATS48” menu.

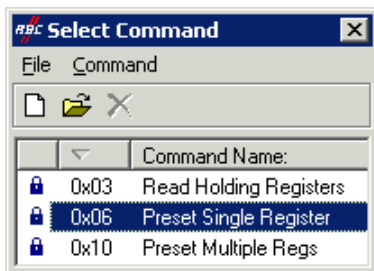
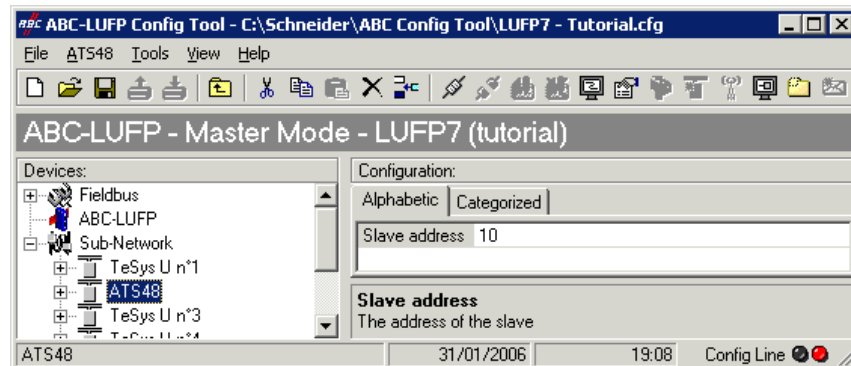

In the window which appears (shown opposite), select the “0x06 Preset Single Register” command and choose “Select” from the “File” menu.

Back in the main ABC-LUFFP Config Tool window, the “Preset Single Register” command now appears in the list of Modbus commands for the “ATS48” node.

6. Configuring the Gateway

Expand the full tree structure for this command, shown below. The correspondence between the various elements which appear in this tree structure and the standard Modbus terminology is located to its right.

Name of the Modbus slave		Name of the Modbus command	Modbus query	↕ Frame ↕
Preset Single Register				
Query				
Slave Address			Slave no.	
Function code			Function no.	
Register address			Word no. (MSB / LSB)	
Preset data			Value of the word (MSB / LSB)	
Checksum			CRC16 (LSB / MSB)	
Response				
Slave Address			Slave no.	
Function code			Function no.	
Register address			Word no. (MSB / LSB)	
Preset data			Value of the word (MSB / LSB)	
Checksum			CRC16 (LSB / MSB)	

These elements can be configured using ABC-LUFP Config Tool, as described in the following chapters.

6.12.2.1. Managing Degraded Modes

PLC processor stopped or on failure

<p>PLC processor response</p> <p>Outputs: Software error: outputs reset to default state or hold their present state depending on configuration. Hardware error: (EEPROM or hardware failure), output state will be indetermined</p> <p>Inputs: PLC stops responding to inputs in any error state.</p>
<p>Profibus master response</p> <p>Depending on master configuration: forces Profibus outputs to 0 and refreshes the inputs, or holds Profibus outputs in their last position, and refreshes the inputs.</p>
<p>LUFP7 gateway response</p> <p>If the master forces Profibus outputs to 0 and refreshes the inputs: all data sent (Write requests) is set to 0, reading from slaves continues to run normally.</p> <p>If the master holds Profibus outputs and refreshes the inputs: all data sent (Write requests) retains its current value, reading from slaves continues to run normally.</p>
<p>Slave response</p> <p>Depending of the slave.</p>

6. Configuring the Gateway

Profibus master stopped or on failure

PLC processor response
The PLC processor provides some error and/or diagnostic objects to the application in case of Profibus master stop or failure (input/output not valid). Refer to the PLC user manual to have their description. This information must be managed in the PLC application.
Profibus master response
If the Profibus master is stopped (command coming from the application): the master stops to communicate with the LUFP7 gateway.
If the Profibus master is on failure: the master stops to communicate with the processor and the LUFP7 gateway.
LUFP7 gateway response
If the master stops to communicate with the gateway, the behavior depends on the fieldbus "Offline options: Clear: All data sent to the concerned Modbus slave is set to 0. Freeze: All data sent retains its current value. No scanning: The query is no longer transmitted.
Slave response
Depending on the slave.

LUFP7 gateways disconnected on Profibus side

PLC response
The PLC processor provides some error and diagnostic objects coming from the Profibus master in case of a slave disconnection from the application. Refer to the PLC user manual to have their description. This information must be managed in the PLC application.
Profibus master response
The Profibus master provides the processor with some error and diagnostic objects in case of Profibus slave disconnection.
LUFP7 gateway response
The behavior depends on the fieldbus Offline options: Clear: All data sent to the concerned Modbus slave is set to 0. Freeze: All data sent retains its current value. No scanning: The query is no longer transmitted.
Slave response
Depending of the slave

6. Configuring the Gateway

LUF7 gateways failure

PLC response
The PLC processor provides some error and diagnostic objects coming from the Profibus master in case of slave failure to the application. Refer to the PLC user manual to have their description. This information must be managed in the PLC application.
Profibus master response
The Profibus master provides the processor with some error and diagnostic objects in case of Profibus slave failure.
LUF7 gateway response
In case of a failure, the gateway stops to communicate with the Profibus master and the Modbus slaves.
Slave response
Depending on the slave.

LUF7 gateways disconnected on Modbus side or slave failure

PLC response
The processor gives access to the gateway status word coming from the Profibus master input table and to the gateway command word coming from the output table. These 2 words must be managed in the PLC application in order to detect if a Modbus slave is missing.
Profibus master response
The Profibus master must be configured to access the gateway status and command words in order to provide Modbus diagnostic information.
LUF7 gateway response
The behavior depends on the different options: Timeout time, number of Retries, Reconnect time and Offline option for sub-network.
Slave response
In case of a Modbus disconnection, the behavior depends on the slave. In case of a slave failure, undetermined state which must be managed in the PLC application.

6. Configuring the Gateway

6.12.2.2. Configuring the Query

Select the “Query” element from the Modbus command. The various elements of the configuration of the query for this command are shown opposite. The values displayed correspond to the default values for any new command.

These elements allow you to configure how the whole command is managed, including how degraded modes are managed (number of re-transmissions, for example).

Alphabetic	Categorized
Offline options for fieldbus	Clear
Reconnect time (10ms)	1000
Retries	3
Timeout time (10ms)	100
Trigger byte address	0x05FF
Update mode	Cyclically
Update time (10ms)	100

Each of these elements is described, in order, in the table below. When a unit is assigned to an element, it is shown in brackets after the name of the element.

Configuration element	Description
Offline options for fieldbus	<p>This element affects the data sent to the Modbus slave, but only in the query to which this element belongs to, whenever the gateway is disconnected from the Profibus-DP network. This element takes one of the following three values:</p> <ul style="list-style-type: none"> - Clear From now on all data sent to the Modbus slave using this query is set to 0x0000 (resetting of the output data in the gateway’s memory). - Freeze..... All data sent to the Modbus slave using this query retains its current values (the output data in the gateway’s memory is frozen). - NoScanning .. The query is no more transmitted to the Modbus slave by the gateway
Reconnect time (10ms) Default value: 10ms x 1000 = 10s	<p>If there is no response from the Modbus slave to a query, or following the receipt of an incorrect response, the gateway uses the “Retries” and “Timeout time (10ms)” elements to carry out re-transmissions. If the Modbus slave has still not responded correctly following these re-transmissions, the gateway stop sending it the corresponding query for a period of time which can be adjusted using “Reconnect time (10ms)”.</p> <p>When this period is over, the gateway attempts to restore communication with the Modbus slave.</p>
Retries Default value: 3	<p>This element indicates the number of re-transmissions carried out by the gateway if there is no response from the Modbus slave to a query, or if the response is incorrect. This re-transmission process ceases as soon as the gateway gets a correct response within a given time. If none of the re-transmissions has allowed the gateway to obtain a correct response, the Modbus slave is deemed to be off-line, but only in relation to the command in question. The gateway then uses the “Offline options for sub-network” and “Reconnect time (10ms)” elements and the LED 5 MODBUS becomes red. This LED will only revert to a green state if the Modbus command is answered with a correct response, once the reconnection has started (see element “Reconnect time (10ms)”).</p> <p>If the number of re-transmissions is set to 0, the process described above will not be run.</p>
Timeout time (10ms) Default value: 10ms x 100 = 1s	<p>This element represents the time that the Modbus slave will wait for a response. If a response has not reached the gateway within the given time, configured using the “timeout time (10ms)” element, the gateway proceeds to a re-transmission. This process continues until it reaches the last re-transmission allowed (see “Retries”), then the gateway declares the Modbus slave off-line, but only for the command to which the “timeout time (10ms)” belongs to.</p>

6. Configuring the Gateway

Configuration element	Description
Trigger byte address	<p>This element is only used by the gateway if “Update mode” is set to “Change of state on trigger”. In this case, it specifies the address, in the gateway’s output memory (0x0202 to 0x02F3), of an 8-bit counter managed by the Profibus-DP master.</p> <p>When the value located at this address is changed by the Profibus-DP master but <i>different from zero</i>, the query configured with a “Change of state on trigger” related to this address is transmitted to the Modbus slave. So the Profibus-DP master must have access to this counter in the same way as for the periodic output registers sent to TeSys U motor starters.</p> <p>In comparison to the “On data change” mode, this mode allows you to send a command on a specific order from the Profibus-DP master if, for example, the latter is unable to update all data from of any given query at the same time.</p> <p>NOTE: In the specific case of the gateway’s default configuration, the “Transactions 1” and “Transactions 2” personalized command mode for the “TeSys U n°1” node is set to “Change of state on trigger”. These aperiodic commands are respectively used to read and write the value of a parameter of one of the Modbus slaves.</p> <p>The “Trigger byte address” elements of the “Query” elements of these two commands are configured at addresses 0x021E and 0x021F. These are the “parameter read/write request counters”. Considered under Profibus-DP, SyCon, and PL7 PRO, these two data are configured the same way as the other outputs (see chapter 4.2.9) and both correspond to the %QW4.0.15 output.</p> <p>To transmit one of these two commands, the Profibus-DP master PLC must first of all update all of the data to be transmitted on the Modbus network for this command (addresses 0x0212 to 0x0217 or addresses 0x0218 to 0x021D), then change the value of the associated counter (address 0x021E or 0x021F). The gateway will then transmit the query corresponding to the command.</p> <p>NOTE: The “trigger byte” does not have to be an item of output data updated by the Profibus-DP master. In fact it is quite possible that it may be an input between 0x0002 and 0x00F3. In this case, the Modbus slave which updates this byte will condition the exchanges of the command you’re currently configuring.</p>
Update mode	<p>This element is used to specify the transmission mode for the query on the Modbus network. It takes one of the following four values:</p> <ul style="list-style-type: none"> - Cyclically..... Default communication mode. The query is transmitted periodically on the Modbus network (see “Update time”). - On data change..... The gateway transmits the query on the Modbus network when at least one item of data from this query is changed by the Profibus-DP master. So this is an aperiodic communication mode. For instance, this is not the case with the queries associated with “Transactions 1” and “Transactions 2” personalized commands for the “TeSys U n°1” node of the gateway’s default configuration. These queries are transmitted when at least one of the values of their output data (addresses 0x0212 to 0x0217 or addresses 0x0218 to 0x0220D) is changed by the Profibus-DP master. So all data from a single query must be updated by the Profibus-DP master at the same time. If you are not certain whether your software is able to update all the output data from a query at the same time, we recommend using “Change of State on trigger” mode for these two commands. - Single Shot..... This transmission mode only allows a single Modbus exchange for the whole of the time that the gateway is operating. This exchange takes place just after the initialization of the gateway. - Change of state on trigger..... With this aperiodic communication mode, the Modbus query is sent every time that the Profibus-DP master changes the value of an 8-bit counter designated by the “Trigger byte address” element. Please see the description of this element for further information about how to use this communication mode.

6. Configuring the Gateway

Configuration element	Description
Update time (10ms) Default value: 10ms x 100 = 1s	This element is only used by the gateway if “Update mode” is set to “Cyclically”. In this case, it specifies the query’s transmission period on the Modbus network.

Returning to our example employing the ATS48 at address 10, we will use the configuration shown opposite. The most notable points of this configuration are:

- On disconnection the data is reset on one of the two networks.
- 3 re-transmissions with a 100 ms timeout.
- Periodic communications with a cycle time set to 300 ms.

Alphabetic	Categorized
Offline options for fieldbus	Clear
Reconnect time (10ms)	1000
Retries	3
Timeout time (10ms)	10
Trigger byte address	0x05FF
Update mode	Cyclically
Update time (10ms)	30

6.12.2.3. Configuring the Response

Next select the “Response” element from the Modbus command. The various elements of the configuration of the response for this command are shown opposite. The values displayed correspond to the default values for any new command.

Alphabetic	Categorized
Offline options for sub-network	Clear <input type="button" value="v"/>
Trigger byte	Disabled
Trigger byte address	0x05FF

These elements allow you to configure a single aspect of managing the command, described below. Each of them is described, in order, in the table below.

6. Configuring the Gateway

Configuration element	Description
Offline options for sub-network	<p>This element affects the input data <i>sent to the Profibus-DP master</i>, but only for the data of the Response to which this element belongs to, whenever the Modbus slave does not answer to the corresponding Query (or upon disconnection from the Modbus sub-network).</p> <p>This element takes one of the following two values:</p> <ul style="list-style-type: none"> - Clear All data sent to the Profibus-DP master for this Response is set to 0x0000 (resetting of the input data in the gateway's memory). - Freeze All data sent to the Profibus-DP master for this Response retain their current values (the input data in the gateway's memory is frozen).
Trigger byte	<p>This element is used by the gateway to activate the unitary incrementation of an 8-bit counter in order to notify the Profibus-DP master of the receipt of a new response to the associated Modbus command. It takes one of the following two values:</p> <ul style="list-style-type: none"> - Disabled..... Default configuration. The gateway does not increment any counter on receipt of the Modbus response. - Enabled Each time that the gateway receives a new response to the associated Modbus command, it increments the value of an 8-bit counter designated by the "Trigger byte address" element (see below). If used, this counter allows the Profibus-DP master, for example, to only consider the response's corresponding data when this counter's value is incremented.
Trigger byte address	<p>This element is only used by the gateway if the element "Trigger byte" is set to "Enabled". In this case, it specifies the address, in the gateway's input memory (0x0002 to 0x00F3), of an 8-bit counter managed by the gateway.</p> <p>When the gateway receives a response to the associated Modbus command, it increments the value of this counter in a unitary manner (value = value+1). So the Profibus-DP master must have access to this counter in the same way as for the periodic input registers from the TeSys U motor starters.</p> <p>This mode allows the Profibus-DP master to be informed that a new response is available. This can be useful, for example, if it is possible that the data from two consecutive responses may be identical.</p> <p>NOTE: In the specific case of the gateway's default configuration, the "Trigger byte" element for responses to the "Transactions 1" and "Transactions 2" personalized commands of the "TeSys U n°1" node is set to "Enabled". Hence, the management of responses to read and write commands for parameters is event driven.</p> <p>The "Trigger byte address" elements of the "Response" elements of these two commands are configured at addresses 0x001E and 0x001F. These are the "parameter read/write response counters". Considered under Profibus-DP, SyCon, and PL7 PRO, these two data are configured the same way as the other inputs (see chapter 4.2.9) and both correspond to the %IW4.0.15 input.</p> <p>The Profibus-DP master PLC will be able to detect the receipt of a response from a Modbus slave by comparing the previous value and the current value of the associated counter (address 0x001E or 0x001F). If there is a <i>unitary incrementation</i> of this counter, the PLC may, for example, read all of the data from the response (addresses 0x0013 to 0x0017 or addresses 0x0018 to 0x001D) and allow the transmission of a new query for reading or writing the value of a parameter (using a "Trigger byte" for the queries). Contrarily to the counter one can associate to the queries of any command, a response's "Trigger byte" is a true modulo 256 counter, <i>i.e.</i> zero must be managed (... 254, 255, 0, 1, 2 ...).</p>

In this example using the ATS48, we do not want the response to be event driven. So we will be retaining the default configuration.

6. Configuring the Gateway

6.12.2.4. Configuring the Content of the Query Frame

The window shown below is obtained using “Edit Transaction” from the “Query” menu. Unlike the tree structure in the main ABC-LUFP Config Tool window, this display has the advantage of showing all of the frame’s fields at the same time as well as their values. The values displayed below correspond to the values assigned by default to the Modbus command query we have created. The correspondence with the content of the corresponding Modbus frame has been added underneath this window.

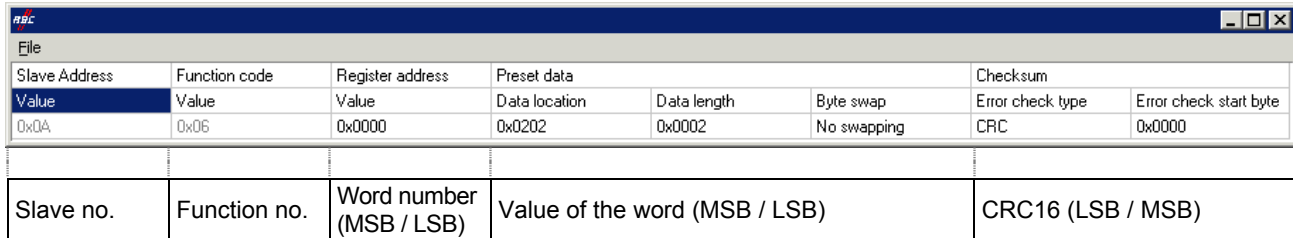

The screenshot shows a window titled 'ABC' with a menu bar containing 'File'. Below the menu bar is a table with the following structure:

Slave Address	Function code	Register address	Preset data			Checksum	
Value	Value	Value	Data location	Data length	Byte swap	Error check type	Error check start byte
0x0A	0x06	0x0000	0x0202	0x0002	No swapping	CRC	0x0000

Below the screenshot is a summary table:

Slave no.	Function no.	Word number (MSB / LSB)	Value of the word (MSB / LSB)	CRC16 (LSB / MSB)
-----------	--------------	-------------------------	-------------------------------	-------------------

Edit the values which are not greyed out, one after another. There is a description of them below.

The nature of a frame’s fields depends on the Modbus command to which it corresponds. However, a certain number of these fields are common to all frames, whereas others are common to a number of them. The description of those shown above is given below, as a part of the example described at the beginning of chapter 6.12.2.

6. Configuring the Gateway

Field in the frame	Size in the frame	Description
Slave Address	1 byte	<p>This field cannot be changed by the user and its value is greyed out to inform him of the fact. ABC-LUFP Config Tool updates the value of this field automatically using the address of the Modbus slave corresponding to the current node.</p> <p>NOTE: This field is common to queries for all Modbus commands.</p> <p><i>E.g.:</i> The value of this field is set to the address of the Modbus slave which corresponds to the “ATS48” node, that is to say to 0x0A.</p>
Function Code	1 byte	<p>This field cannot be changed by the user and its value is greyed out to inform him of the fact. ABC-LUFP Config Tool updates the value of this field automatically using the function code for the corresponding Modbus command.</p> <p>NOTE: This field is common to queries for all Modbus commands.</p> <p><i>E.g.:</i> The value of this field is set to the code for the “Preset Single Register” command (writing the value of an output word), that is to say 0x06.</p>
Register Address	2 bytes	<p>Address of an output word, or of a register, in the Modbus slave’s memory. So this field designates the memory object to which the command relates.</p> <p>NOTE: This field is common to queries for all Modbus commands whose purpose is to access one or more locations in the memory of a Modbus slave. When accessing several memory locations, the “Register” field designates the address of the first word affected by the command.</p> <p><i>E.g.:</i> The value of this field should be changed by entering the address of the CMD command register, that is to say 400 (0x0190). This value will be automatically converted to hexadecimal if the user enters it in decimal.</p>
Preset Data	2 bytes or more for a block of data	<p><u>Data Location:</u> Address, in the gateway’s output data memory (0x0202 to 0x02F3), of the item of data to be transmitted in the “Preset Data” field for the query’s frame.</p> <p>NOTE: The “Data location” field is used for each frame that allows you to exchange some data between the Modbus slaves and the Profibus-DP master. In this case it designates the starting address of the block of data to be transmitted.</p>

WARNING

RISK OF UNINTENDED EQUIPMENT OPERATION

The user must use even values for the “Data Location” field (*i.e.* 514, 516, 518, etc.). The selection of odd data locations complicates application programming and increases the likelihood of improper Modbus values being written to or read from the slave devices. Depending on the user’s configuration, unintended equipment operation may result.

Failure to follow this instruction can result in death, serious injury, or equipment damage.

6. Configuring the Gateway

Preset Data (continued)		<p>Returning to our previous example, the value to be assigned to the ATS48's CMD register should be placed in the gateway's output data memory area. We will be using the first free location starting at an even address, that is to say the one located at 0x0220, with the gateway's default configuration.</p> <p><u>Data length</u>: Length of the block of output data, in the gateway's memory, whose values must be transmitted in the "Preset Data" field of the query's frame. It is expressed in number of bytes.</p> <p>NOTE: The "Data length" field is always used together with the "Data location" field, described above.</p> <p><i>E.g.:</i> Since the "Preset Single Register" command is used to write the value of a single register (16-bit), the value of the "Data length" field must be set to 2.</p> <p>See the documentation for each Modbus slave to find out the maximum amount of 8-bit data which can be placed in "Data" type fields in queries and responses for this slave. With the ATS48, for instance, it is limited to 30 16-bit words (Data length field limited to ≤ 60).</p>
Field in the frame	Size in the frame	Description
Preset Data (continued)		<p><u>Byte swap</u>: Specifies whether the output data bytes to be transmitted to the Modbus slave must be swapped before being placed in the Modbus frame or not. The three possible values are as follows:</p> <ul style="list-style-type: none"> - No swappingDefault configuration. The data is sent in the same order as they appear in the gateway's memory. This is the case which must be used by default, because for an item of 16-bit data, the most significant byte is placed first in the Modbus frame and is always written into the gateway's memory by a Profibus-DP master with the most significant byte first. - Swap 2 bytes.....The bytes to be transmitted are swapped two by two. - Swap 4 bytes.....The bytes to be transmitted are swapped four by four. This is rarely used, as it only relates to 32-bit data. The principle is similar to that of the previous case, "Swap 2 bytes". <p><i>E.g.:</i> We will be using the "No swapping" value, because the two bytes of the value to be written into the ATS48's CMD register, as transmitted by the TSX PBY 100 coupler, are placed into the gateway's memory in most significant / least significant order.</p>
Checksum	2 bytes	<p><u>Error check type</u>: Type of error check for the frame.</p> <ul style="list-style-type: none"> - CRC.....Default method. <p>This is the method adopted for the Modbus RTU protocol. It cannot be changed.</p> <p><u>Error check start byte</u>: Indicates the number of the byte, in the frame, from which the calculation of the "checksum" should begin. The first byte in each frame carries the number 0.</p> <p>NOTE: The calculation of a frame's checksum should always begin with the first byte. Do not change the error check start byte from its default of zero. A non-zero value will result in an incorrect CRC, and all Modbus communications will return an error.</p>

6. Configuring the Gateway

6.12.2.5. Configuring the Content of the Response Frame

The window shown below is obtained using “Edit Transaction” from the “Response” menu. The values shown in it correspond to the values assigned by default to the Modbus command response we have created. The correspondence with the content of the corresponding Modbus frame has been added underneath this window.

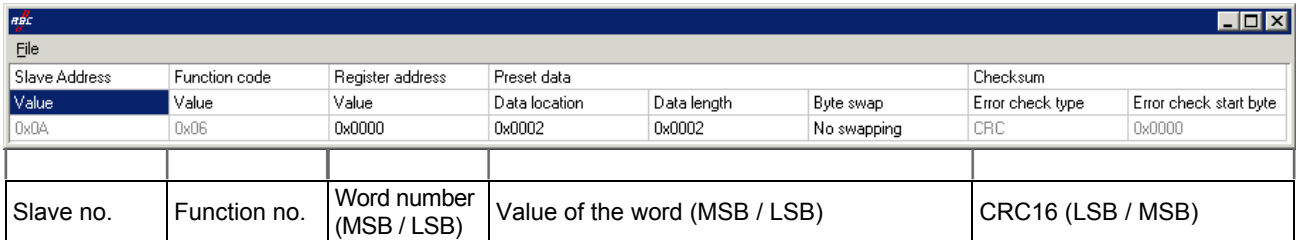

Slave Address	Function code	Register address	Preset data			Checksum	
Value	Value	Value	Data location	Data length	Byte swap	Error check type	Error check start byte
0x0A	0x06	0x0000	0x0002	0x0002	No swapping	CRC	0x0000
Slave no.	Function no.	Word number (MSB / LSB)	Value of the word (MSB / LSB)		CRC16 (LSB / MSB)		

Edit the values which are not greyed out, one after another.

There is a description of them below, but also see the previous chapter, as the nature of the content of response frames is very similar to that of the fields in Modbus query frames.

NOTE: If the value of a field from the response of a Modbus slave is different from that configured via ABC-LUFP Config Tool, the response will be rejected by the gateway. It will then proceed to a re-transmission of the query, provided that at least one re-transmission has been configured for this command (see chapter 6.12.2.2).

6. Configuring the Gateway

Field in the frame	Size in the frame	Description
Slave Address	1 byte	Identical to that of the query's "Slave Address" field.
Function Code	1 byte	Identical to that of the query's "Function" field.
Register Address	2 bytes	Identical to that of the query's "Register" field, since the Modbus response of any "Preset Single Register" command is an echo to the corresponding query. Here you should also enter the address of the memory object to which the command relates. If receiving an exception code, see (*).
Preset Data	2 bytes or more for a block of data	<u>Data Location</u> : Address, in the gateway's input data memory (0x0002 to 0x00F3), of the item of data received in the "Preset Data" field for the response's frame. NOTE Check that the data is located at even addresses in order to align the Modbus data (in 16-bit format) on the %IW4.0.x inputs of the Profibus-DP coupler. <i>E.g.</i> : The value sent back as an echo to the command must be placed in the gateway's input data memory area. We shall use the first two free bytes following the input data of the default configuration, i.e. addresses 0x0020-0x0021. If receiving an exception code, see (*).

WARNING

RISK OF UNINTENDED EQUIPMENT OPERATION

The user must use even values for the "Data Location" field (*i.e.* 2, 4, 6, etc.). The selection of odd data locations complicates application programming and increases the likelihood of improper Modbus values being written to or read from the slave devices. Depending on the user's configuration, unintended equipment operation may result.

Failure to follow this instruction can result in death, serious injury, or equipment damage.

		<u>Data length</u> : Length of the block of input data received in the "Preset Data" field of the response frame. It is expressed in number of bytes. <i>E.g.</i> : The value of the "Data length" field must be set to 2.
		<u>Byte swap</u> : Identical to that of the query's "Byte swap" field. <i>E.g.</i> : We will also be using the "No swapping" value, for the same reasons as with the query.
Checksum	2 bytes	<u>Error check type</u> : Identical to that of the query's "Error check type" field. <u>Error check start byte</u> : Identical to that of the query's "Error check start byte" field. NOTE : These two fields cannot be changed by the user and their values are greyed out to reflect this. ABC-LUFP Config Tool updates the values of these fields automatically using those of the query's "Error check type" and "Error check start byte" fields.

(*) If receiving an exception code, the gateway re-transmits the request according to the number of retries that has been defined. Then, it will disconnect the slave.

6. Configuring the Gateway

6.12.3. Adding a Special Modbus Command

Apart from the standard Modbus commands covered in the previous chapter, it is possible to create two types of special Modbus commands: Modbus commands using the same template as standard commands and Modbus commands whose nature and frame content can be completely changed by the user.

6.12.3.1. Modbus Commands Based on Standard Commands

You create a command of this type from the “Select Command” window (see chapter 6.12.2), by choosing “Add Command” from the “Command” menu. The window shown below appears. It shows the structure of the future command’s query and response frames, which will then be added to the list of available Modbus commands. This structure includes the standard elements, that is to say the “Slave Address”, “Function” and “Checksum” fields, described in previous chapters.

Query	1	2	3	4
DisplayName	Slave Address	Function Code	Data	Checksum
ObjectType	Byte	Byte	Data	Checksum
Value	[SlaveAddress]	ID	User	User

Response	1	2	3	4
DisplayName	Slave Address	Function Code	Data	Checksum
ObjectType	Byte	Byte	Data	Checksum
Value	[SlaveAddress]	ID	User	Depend

Please see chapter 2.12 Command editor in the ABC-LUFP Config Tool user manual, entitled **AnyBus Communicator – User Manual** for further information about creating standard Modbus commands. This manual can be found on the <http://www.telemecanique.com> website: “ABC_User_Manual .pdf”.

6.12.3.2. User-Customizable Modbus Commands

In ABC-LUFP Config Tool, these commands are known as “Transactions”. Unlike in the previous examples where many of the variables were fixed by the Modbus command selected, the whole structure of the query and response frames associated with these transactions is dictated by data in the gateway’s memory. These data fields in the gateway’s memory may contain constant and ranged values in Byte, Word or DWord format and a final “Checksum” field.

(See Query’s table for details)

All of the data contained in the query and response “Data” and “Variable Data” fields of a “Transactions” command are managed by the Profibus-DP master, including the “Slave address” and “Function” fields if these are placed in a “Data” field. For instance, this allows you to manage all of the Modbus frame fields from the Profibus-DP master if all of the query and response fields of a “Transactions” element (excluding “Checksum”) are “Data” type fields, or “Variable Data” type fields for data with a variable data size (e.g. the Response to a Query used to read a variable number of registers); see chapter 6.12.3.3 for a description.

6. Configuring the Gateway

WARNING

MORE THAN ONE “DATA” FIELD IN A MODBUS FRAME

Do not use more than one “Data” field per Modbus frame. Multiple “Data” fields in a single Modbus frame may not be executed in the proper order by the gateway, leading to unintended consequences.

It is preferable for the master to set this data as only one “Data” field, even if this means that in-between constants would become part of this “Data”, and thus be exchanged with the master.

Concerning “Variable Data”, there can be only one such field in any Modbus frame (Query or Response). Thus, the “Add Variable Data” command of ABC-LUFP Config Tool will be disabled if the current frame already includes a “Variable Data” field.

Failure to follow this instruction can result in death, serious injury, or equipment damage.

Constants in Byte, Word or DWord format place the values of these constants in Modbus query frames (constants in “Query” elements) or by comparing them to the values located in the Modbus responses (constants in “Response” elements). These comparisons are used to accept (identical values) or reject (different values) the Modbus responses in the same way as for standard Modbus commands. The Profibus-DP master does not have access to these constants. They are mainly used to replace fields such as “Slave address,” “Function,” “Starting Address,” etc.

Please refer to the section on “Produce/Consume Menu” in chapter 5.4.2 **Transaction** and in chapter 5.5 **Frame objects** in the ABC-LUFP Config Tool user manual, entitled **AnyBus Communicator – User Manual** for further information about how to handle “Transaction” type commands. This manual can be found on the <http://www.telemecanique.com> website: “ABC_User_Manual.pdf”.

The LUFP7 gateway’s default configuration includes two “Transaction” commands. These are aperiodic commands used for reading and writing the value of a Modbus slave parameter (necessarily a TeSys U motor starter with the default configuration). They are configured solely for the “TeSys U n°1” node, as the address of the slave is controlled by the Profibus-DP master via the first byte of the “Data” field, which corresponds to the “Slave Address” field in standard Modbus commands. This allows the Profibus-DP master to send this command to all of the Modbus slaves, slave by slave, through the first byte of the “Data” field. The remaining fields of the frames used by these two commands are also placed in the same “Data” field. So the Profibus-DP master has access to all of the content of the frames in these two commands.

6.12.3.3. Using “Variable Data” Fields in Transactions

A “Variable Data” field is similar to a “Data” field, but has no predefined length. Instead, a length character (*i.e.* a number of bytes) **or** an end character is used to indicate the *significant length* of the data field. Each “Variable Data” field is also protected with a “Maximum Data Length” that prevents any overflow when there is no “end character” where one is expected, or when the “length character” is too high.

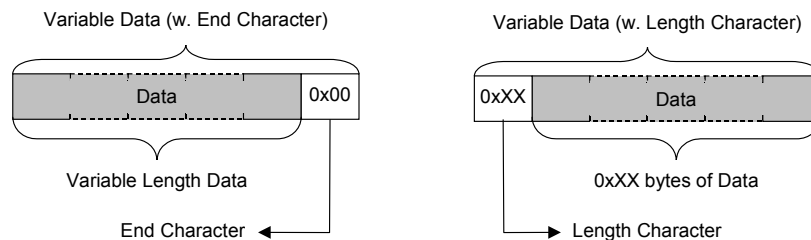

The end / length character of any “Variable Data” located in the Queries of Transactions must be supplied by the Profibus-DP master because it is the producer of this data.

6. Configuring the Gateway

The end / length character of any “Variable Data” located in the Responses of Transactions is generally produced by the LUPF7 gateway, not by a Modbus slave! But the Response of the Read Holding Registers (Modbus command 0x03) is an exception to this rule, because its “Byte count” field can be used as the length character (refer to the examples given at the end of the current chapter).

NOTE: Only one “Variable Data” field is allowed in any Query or Response of a Transaction.

The following table describes the properties of any “Variable Data” field:

Property	Notes
Byte swap	<p>As for the standard “Data” field. As a reminder, the three possible values are as follows:</p> <ul style="list-style-type: none"> No swapping: Default configuration for a Profibus-DP master. The data is sent in the same order as it appears in the gateway’s memory. This is the case which must be used by default. Swap 2 bytes: The bytes to be transmitted are swapped two by two. Swap 4 bytes: The bytes to be transmitted are swapped four by four.
Data location	<p>For a Query: Starting address, in the gateway’s output data memory (0x0202 to 0x02F3), of the data sent by the Profibus-DP master and destined to the Modbus slave. This data is directly inserted in the Query frame, at the position of the current “Variable Data” field.</p> <p>For a Response: Starting address, in the gateway’s input data memory (0x0002 to 0x00F3), of the data sent by the Modbus slave and destined to the Profibus-DP master. This data is directly retrieved from the Query frame, at the position of the current “Variable Data” field.</p> <p>NOTE: In both cases, the end / length character (if actually used) is <i>part of the data</i>; thus, it can also be found in the input / output data memory of the gateway.</p>
End Character Value	<p>This property is only used if “Object Delimiter” is set to “End Character” or “End Character visible”. It is used to mark the end of the data. Of course, this specific character must be forbidden inside the data.</p> <p>Thus, for example, it is common practice to end text strings with a “zero” character because 0x00 cannot be used in written text; this is known as the ASCIZ representation. <i>E.g.</i> the string “ABC” becomes the string { 0x41 , 0x42 , 0x43 , 0x00 } in ASCIZ.</p>
Fill un-used Bytes	<p>This property is only used for “Variable Data” located in the Responses of Transactions because the “Variable Data” located in the Queries is only updated by the master. Only two choices are available for this property:</p> <ul style="list-style-type: none"> Disabled: Unused data (<i>i.e.</i> data located after the last character or beyond the end character) is not updated in any way; it keeps the current value. Enabled: Unused data bytes are filled with the value set in “Filler Value”. For example, if the “Filler Value” is equal to 0xFF, then all data located after the last character or beyond the end character is set to 0xFF.
Filler Value	<p>If “Fill un-used Bytes” is set to “Enabled” for the “Variable Data” of a Response, then this value is copied into each byte located after the last character or beyond the end character.</p>
Maximum Data Length	<p>The combination of “Data location” and “Maximum Data length” properties determines the input / output memory used to exchange data between the Profibus-DP master and the Modbus slave, exactly like the “Data Location” and the “Data length” properties of the Standard “Data” fields.</p> <p>NOTE: This maximum length <i>must</i> include the “end character” or the “length character” if any one of these characters is used (see “Object Delimiter”, below). When used, this character is <i>always</i> present in the input / output memory, even if it is not exchanged</p>

6. Configuring the Gateway

	with the Modbus slave (<i>i.e.</i> if the optional “visible” item has not been chosen).
Object Delimiter	<p>This property is critical because it dictates the method used to sort out useful data from the whole input / output data allocated for the “Variable Data”. There are five possibilities:</p> <ul style="list-style-type: none">• Length Character: The first byte in the input / output memory represents the length of the significant data (length character excluded). This character <i>is not</i> located in the Modbus Query or Response; it is either produced by the gateway (based upon the length of the Modbus Response), or by the Profibus-DP master (who alone updates the output data).• Length Character visible: Same as “Length Character”, but this character becomes part of the Modbus Query or Response; it is either produced by the Modbus slave (in the Response) or by the Profibus-DP master (in the Query).• End Character: The significant data ends on the first occurrence of the “End Character Value”. This character <i>is not</i> located in the Modbus Query or Response; it is either produced by the gateway (based upon the length of the Modbus Response), or by the Profibus-DP master (who alone updates the output data).• End Character visible: Same as “End Character”, but this character becomes part of the Modbus Query or Response; it is either produced by the Modbus slave (in the Response) or by the Profibus-DP master (in the Query).• No Character: This option is reserved for Responses only. With “No Character”, upon receiving a response that contains some “Variable Data”, the gateway simply copies the data from the frame to its input memory. Hence, the Profibus-DP master cannot determine the real length of the significant data (<i>i.e.</i> the data that has been updated).

6. Configuring the Gateway

Example 1:

Configuration of the communications between a LUF7 gateway and only one Modbus slave (a TeSys U motor starter located at address 1 on the Modbus sub-network, and named “TeSys U n°1”):

- The first two bytes of the input memory (0x0000-0x0001) and the first two bytes of the output memory (0x0200-0x0201) of the gateway are reserved for the gateway initialization and diagnostics (see chapter 5), but in the “Diagnostic and Control” mode (“Control/Status Word = Enabled but no startup lock” for the “ABC-LUF7” element).
- 1 “Read Holding Registers” command (FC 0x03): Periodic command (“Update mode = Cyclically” and “Update time (10ms) = 30” for the Query) used to get the status of the TeSys U motor starter (“Starting register address = 0x01C7 = 455” and “Number of registers = 0x0001” in the Query; “Byte count = 0x02” in the Response); the value of this status is transferred to addresses 0x0002-0x0003 of the input memory of the gateway (“Data length = 0x0002” and “Data location = 0x0002” for the “Data” of the “Response”).
- 1 “Preset Multiple Regs” command (FC 0x10): Periodic command (“Update mode = Cyclically” and “Update time (10ms) = 30” for the Query) used to set the command of the TeSys U motor starter (“Starting register address = 0x02C0 = 704”, “Number of registers = 0x0001”, and “Byte Count = 0x02” in the Query; but also “Starting register address = 0x02C0 = 704” and “Number of registers = 0x0001” in the Response); the value of this command is transferred to addresses 0x0202-0x0203 of the output memory of the gateway (“Data length = 0x0002” and “Data location = 0x0202” for the “Data” of the “Query”).
- 1 “Transactions” command: Periodic command (“Update mode = Cyclically” and “Update time (10ms) = 100” for the Query) used to get *from one to five* status registers (exact number in 0x0204-0x0205) from the TeSys U motor starter (starting at register 455 / 0x01C7); the value of these registers is transferred to addresses 0x0006-0x000F of the input memory of the gateway (length of 2, 4, 6, 8, or 10 bytes, depending on the number of registers actually read, for a maximum of 10 bytes). The contents of this command is detailed below because our example focuses on it:
 - The Query is made of the following fields, in this order:
 - 1 “Byte, Constant” field, renamed as “Address”: 0x01 (address of the Modbus slave).
 - 1 “Byte, Constant” field, renamed as “Function code”: 0x03 (function code of a “Read Holding Registers” command).
 - 1 “Word, Constant” field, renamed as “Register Address”: 0x01C7 (to emulate the “Starting register address” field of the FC 0x03).
 - 1 “Data” field, with “Data length = 0x0002” and “Data location = 0x0204” (to replace the “Number of registers” field of the FC 0x03); the Profibus-DP master uses this output data field to set the number of status registers (from 1 to 5) he wants to read from the TeSys U slave.
 - 1 “Checksum” field (mandatory: CRC at 0x0000).
 - The Response is made of the following fields, in this order:
 - 1 “Byte, Constant” field, renamed as “Address”: 0x01 (address of the Modbus slave).
 - 1 “Byte, Constant” field, renamed as “Function code”: 0x03 (function code of a “Read Holding Registers” command).
 - 1 “Byte, Limits” field, renamed as “Byte count”, and with “Minimum Value = 0x02” and “Maximum Value = 0x0A” (to emulate the “Byte count” field of the FC 0x03); these limits restrict the Response for reading from 1 to 5 registers (2 to 10 bytes).
 - 1 “Variable Data” field that replaces the standard “Data” field generally used for the FC 0x03; its properties are set as follows:
 - “Byte swap = No Swapping” The default case for a Profibus-DP master.
 - “Data location = 0x0005” The data begins at 0x0005 with the “Length Character” (see below); thus, *the significant data really begins at 0x0006* (this aligns the 16-bit data on even memory addresses).
 - “End Character Value = 0x00” Not used here.
 - “Fill un-used Bytes = Enabled” In this example, the not-up-to-date input data read from the TeSys U slave will be set to 0xFF (the “Filler Value”).

6. Configuring the Gateway

- “Filler Value = 0xFF” The value copied into the not-updated data retrieved from the Response frame, *i.e.* for data located beyond the last character, as indicated by the “Length Character”.
- “Maximum Data length = 0x000B” A maximum of 11 bytes must be accepted and allocated in the input memory (from 0x0005 to 0x000F); the first byte is the “Length Character” and the other ten bytes are the significant data, retrieved from the frame of the Response sent by the Modbus slave.
- “Object Delimiter = Length Character” ... This mode states that the first input data byte (here, 0x0005) is the length of the significant data (0x0005 excluded); it also states that, as a not “visible” character, this byte is not located in the frame of the Response, but evaluated by the gateway, depending on the *real length* of the Response frame.
 - 1 “Checksum” field (mandatory: CRC at 0x0000).

With this configuration, the contents of the gateway memory is as follows:

Input Memory (16 bytes)		Output Memory (6 bytes)	
0x0000-0x0001	Gateway: Status Word	0x0200-0x0201	Gateway: Control Word
0x0002-0x0003	TeSys U: Status Register (455)	0x0202-0x0203	TeSys U: Command Register (704)
0x0004	Spare / Not used	0x0204-0x0205	Number of registers to read (1-5)
0x0005	Significant Data length		
0x0006-0x0007	1st status register (455)		
0x0008-0x0009	2nd status register (456)		
0x000A-0x000B	3rd status register (457)		
0x000C-0x000D	4th status register (458)		
0x000E-0x000F	5th status register (459)		

Use your Profibus-DP configuration tool to resize the I/O data exchanged between the master (TSX PBY 100) and the LUPF7 gateway; use an “INPUT: 16 Byte (8 word)” module and an “OUTPUT: 6 Byte (3 word)” module.

Under PL7 PRO, for a TSX PBY 100 coupler inserted into the slot #2 of a TSX Premium PLC, these I/O translate into the following:

Inputs (8 words)		Outputs (3 words)	
%IW2.0	Gateway: Status Word	%QW2.0	Gateway: Control Word
%IW2.0.1	TeSys U: Status Register (455)	%QW2.0.1	TeSys U: Command Register (704)
%IW2.0.2	Significant Data length (bits 0-7)	%QW2.0.2	Number of registers to read (1-5)
%IW2.0.3	1st status register (455)		
%IW2.0.4	2nd status register (456)		
%IW2.0.5	3rd status register (457)		
%IW2.0.6	4th status register (458)		
%IW2.0.7	5th status register (459)		

6. Configuring the Gateway

For a motor starter commanded into RUN mode (%QW2.0.1 = 0x0001), its status can be read in %IW2.0.1 (0x0043), but also from %IW2.0.3 to %IW2.0.7, depending on the number of registers actually read (%QW2.0.2 = 0x0001 to 0x0005):

Resulting Inputs	Value of %QW2.0.2				
	0x0001	0x0002	0x0003	0x0004	0x0005
%IW2.0.2	0x0002	0x0004	0x0006	0x0008	0x000A
%IW2.0.3	0x0043	0x0043	0x0043	0x0043	0x0043
%IW2.0.4	0xFFFF	0x0000	0x0000	0x0000	0x0000
%IW2.0.5	0xFFFF	0xFFFF	0x000D	0x000D	0x000D
%IW2.0.6	0xFFFF	0xFFFF	0xFFFF	0x0001	0x0001
%IW2.0.7	0xFFFF	0xFFFF	0xFFFF	0xFFFF	0x0000

Please note that the gateway sets to 0xFF (the “Filler Value”) any byte located beyond the last significant byte.

Example 2:

The configuration described in *Example 1* is also used here, with the two following exceptions:

- In the “Variable Data”, the “Byte, Limits”, renamed as “Byte count”, and with “Minimum Value = 0x02” and “Maximum Value = 0x0A”; this field is removed from the Response because it is now included in the data retrieved from the frame of the Response and copied into the input memory of the gateway (look at the values of %IW2.0.2 / 0x0005 to get convinced of this fact)
- In the “Variable Data”, the “Object Delimiter = Length Character” becomes “Object Delimiter = Length Character visible”; this instructs the gateway to retrieve the “length character” (1 byte) from the Response frame of the Modbus slave instead of evaluating it with the Response frame's remaining length.

As these two modifications mutually compensate one another in the specific case of a “Read Holding Register” command, the results described at the end of *Example 1* also apply here.

6.13. Configuring the General Characteristics of the Gateway

This operation relates to the gateway’s general characteristics (“Fieldbus” to “Sub-Network” elements), whereas the previous chapters described the configuration of the Modbus slaves (elements located under the “Sub-Network” element).

The “Fieldbus” element describes the upstream network, that is to say the Profibus-DP network in the case of the LUF7 gateway.

The “ABC-LUF7” and “Sub-Network” elements describe the downstream network, that is to say the Modbus RTU network in the case of the LUF7 gateway, and allow you to identify the software version in the gateway.

The configuration of these three elements, plus the commands they give access to, are described in the next three chapters.

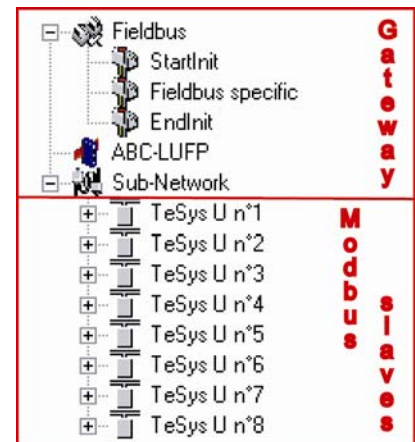

6.13.1. “Fieldbus” Element

Below this element there is a list of the mailboxes configured by default. These elements are not described here, as they are only designed for the internal management of the gateway. These mailboxes can neither be changed nor deleted. Both their number and their nature depend on the type of upstream network.

6. Configuring the Gateway

When the “Fieldbus” element is selected, you can select the type of upstream network: “Profibus-DP” with the LUF7 gateway.

If your PC is connected to the gateway using the PowerSuite cable and you are using ABC-LUFP Config Tool in “on-line” mode when ABC-LUFP Config Tool starts up, the type of upstream network will be automatically detected.

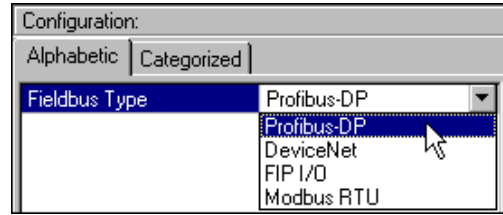

The only command accessible from the “Fieldbus” menu is “Restore Default Mailboxes”. The usage of this command is recommended if you inadvertently inserted a user-defined Mailbox under the “Fieldbus” device. As Mailboxes are not meant to be used with the LUF7 gateway, only the Default Mailboxes should be set under the “Fieldbus” device, in the following order:

- StartInit
- Fieldbus specific
- EndInit

Should any other Mailbox also appear in this list, please perform the “Restore Default Mailboxes” command. Then, confirm the operation by clicking on the “Yes” button in the confirmation / warning window that appears.

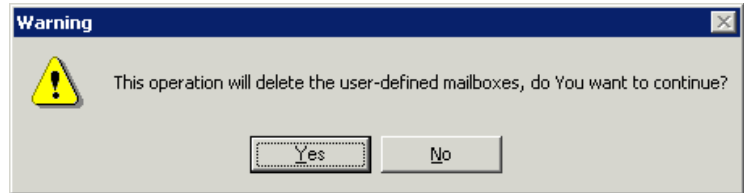

6.13.2. “ABC LUFP” Element

The sole command accessible from the “ABC-LUFP” menu is “Disconnect” (or “Connect” if you are in “off-line” mode); please refer to chapter 6.3, for details about “on-line” and “off-line” modes.

In the configuration of the LUF7 gateway’s “ABC-LUFP” element, the “Physical Interface” and the “Protocol Mode” properties *must not* be changed. Their value, respectively, must always be set to “Serial” and “Master Mode”.

6. Configuring the Gateway

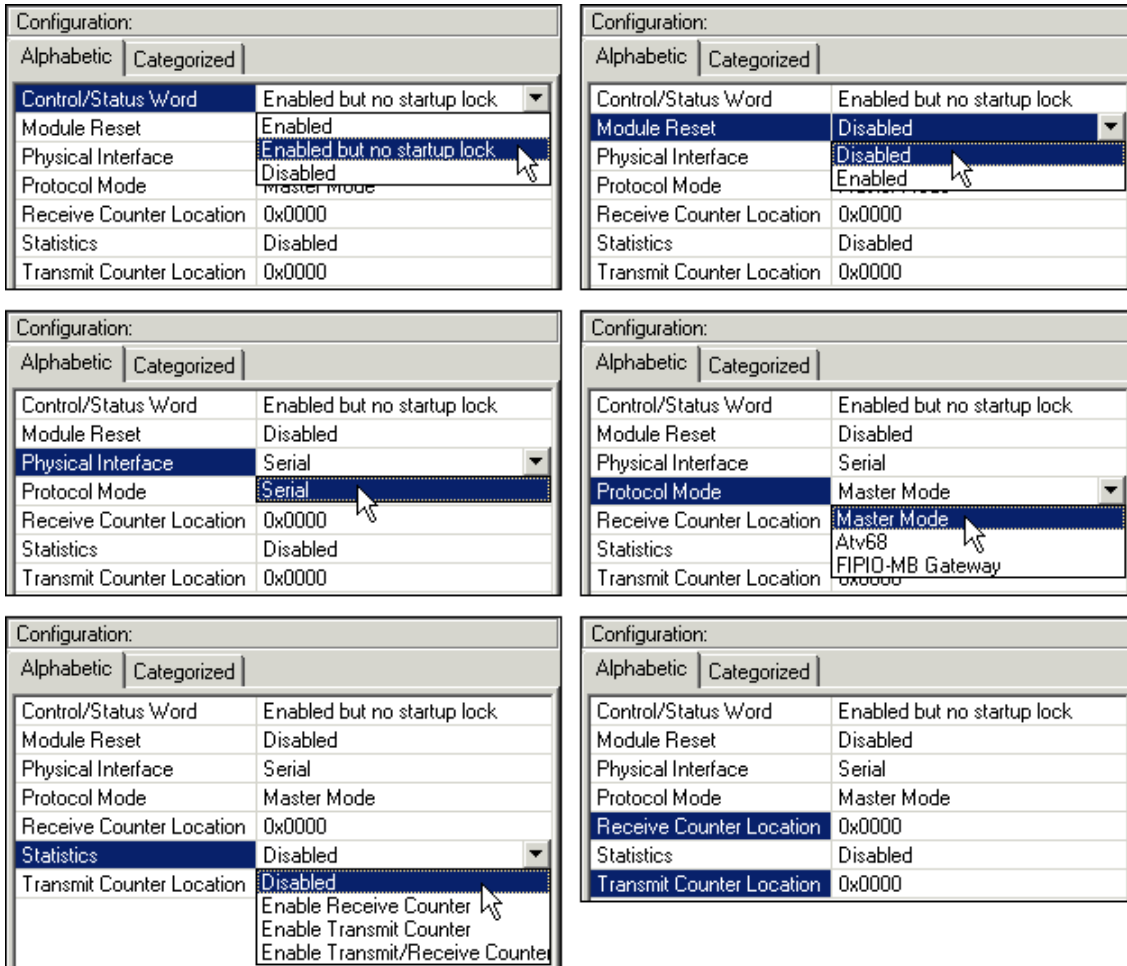

These seven properties allow you to configure some of the gateway's system aspects:

- **Control/Status Word:** The three possibilities offered for this property are described in chapter 5 .
- **Module Reset:** By default, this property prevents the gateway from reinitializing itself when there is an internal operation problem. Changing this option is mainly intended for “laboratory” type use.
- **Physical Interface:** The only possibility offered by this property shows that the physical interface of the downstream network of the gateway (Modbus) is a serial link.
- **Protocol Mode:** This property should not be changed, because it indicates the type of protocol used on the downstream network of the gateway. With the LUF7 gateway, “Master Mode” must be selected. The other possibilities available are reserved for other products from the same family as this gateway.
- **Statistics:** This property dictates the presence or absence of the two Receive and Transmit Counters in the input memory of the gateway (see below). The four possibilities are:
 - Disabled: The two “Receive Counter Location” and “Transmit Counter Location” properties are ignored.
 - Enable Receive Counter: Only the “Receive Counter Location” property is used by the gateway.
 - Enable Transmit Counter: Only the “Transmit Counter Location” property is used by the gateway.
 - Enable Transmit/Receive Counter: Both the “Receive Counter Location” and “Transmit Counter Location” properties are used by the gateway.

6. Configuring the Gateway

- **Receive Counter Location:** This property is only used by the gateway if “Statistics = Enable Receive Counter” or “Statistics = Enable Transmit/Receive Counter”. It represents the 1-byte input memory address (from 0x0000 to 0x00F3) where the Modbus Responses counter is copied into. As any other used input memory data, this byte will increase the size of data exchanged with the Profibus-DP master. This is a modulo 256 counter (*i.e.* it starts over at 0 once it goes past 255) which is updated each time a Modbus frame is received by the gateway.
- **Transmit Counter Location:** This property is only used by the gateway if “Statistics = Enable Transmit Counter” or “Statistics = Enable Transmit/Receive Counter”. It represents the 1-byte input memory address (from 0x0000 to 0x00F3) where the Modbus Queries counter is copied into. As any other used input memory data, this byte will increase the size of data exchanged with the Profibus-DP master. This is a modulo 256 counter (*i.e.* it starts over at 0 once it goes past 255) which is updated each time a Modbus frame is emitted by the gateway, retries included.

Finally, a useful command from the “Help” menu will allow you to check the software versions of the LUF7 gateway (the “ABC-LUFP” element), but only in “on-line” mode; of course, it also shows the version of the ABC-LUFP Config Tool.

To get this information, execute the “About...” command of the “Help” menu. An example in “on-line” mode is given here:

In “off-line” mode, all versions and information from the “Sub-Network” and “Fieldbus” categories are replaced with “Unknown” since they could not be obtained from an existing and connected gateway.

The “http://www.hms.se/abc_lufp.shtml” text is an hypertext link. By clicking on it, you are directly redirected to the **Schneider Electric's** Web page dedicated to the ABC-LUFP gateways.

This page features many downloadable items related to the family of LUF7 gateways, including the latest version of ABC-LUFP Config Tool.

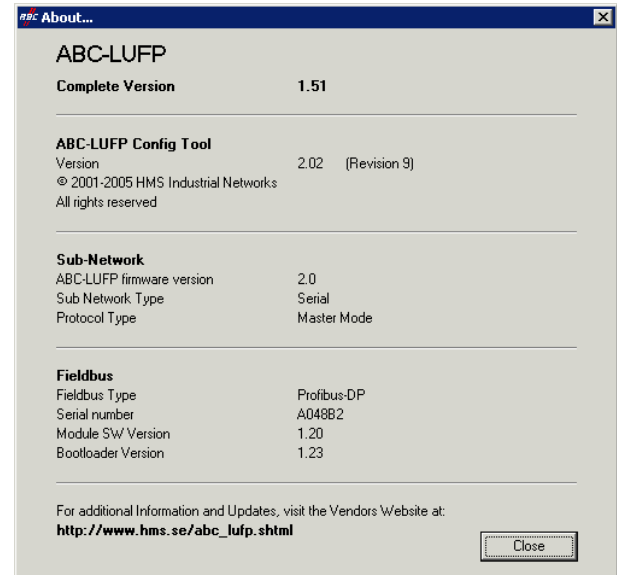

6.13.3. “Sub-Network” Element

The five commands accessible from the “Sub-Network” menu are:

- “Paste”: Appends a copy of the last copied node (after a “Copy” command on an existing node), or a replica of the cut node (after a “Cut” command), to the list of nodes of the “Sub-Network” element. This command is only available if a node has been previously copied or cut, and only if the 8 nodes limit has not been reached yet.
- “Sub-Network Monitor”: Allows you to view the correspondence between the data from Modbus commands and the content of the gateway’s memory. Examples of how to use this command are shown in chapters 6.9.3, 6.9.4 and 6.10.

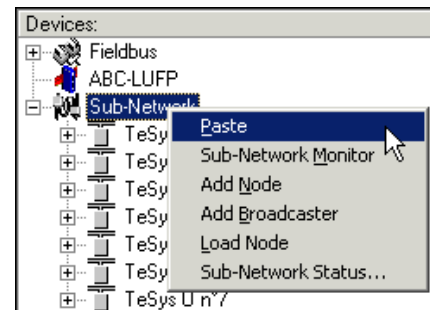

6. Configuring the Gateway

- “Add Node”: Allows you to add a new node on the downstream Modbus network. Each node corresponds to a different Modbus slave. This command is not available if there are already 8 Modbus slaves, which is the case with the gateway’s default configuration.
- “Add Broadcaster”: Allows you to add a broadcaster node (see chapter 6.14).
- “Load Node”: Allows you to add a pre-configured node on the downstream Modbus network. The configuration for this node is contained in an XML file (see the section on “Importing/Exporting a Modbus slave configuration” in chapter 6.8). This command is not available if there are already 8 Modbus slaves, which is the case with the gateway’s default configuration.
- “Sub-Network Status...”: In “on-line” mode (see chapter 6.13.2), this command displays a window summarizing the values of the gateway’s error counters. These counters are also used by the gateway to update the value of its status word (see chapter 5.2.2). The “Update” button allows you to refresh the values of these counters.

When you run this command in “off-line” mode, all of the values displayed are replaced by the word “Unknown” to show that they cannot be read on the gateway. The “Update” button then becomes inaccessible.

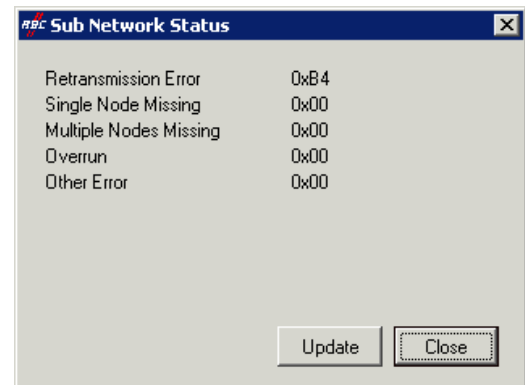

NOTE: The “Sub Network Status” window may be useful to detect problems on the Modbus sub-network. So, if the number of retransmission errors increases upon using the “Update” button, this denotes the absence of one or more slaves, Modbus cabling or speed problems, or invalid Commands and/or Transactions. Since retransmission errors tend to lower the general performances of the Modbus communications, you should undertake actions to prevent these retransmission errors from increasing!

When the “Sub-Network” element is selected, you have access to all of the options allowing you to configure the gateway’s communication protocol format on the Modbus network. The various settings you can make are described below. All of the Modbus slaves present must support this configuration and be configured appropriately.

- Bitrate (bits/s): The gateway supports a limited number of communication speeds. Choose the speed that suits your Modbus network.
- Data bits: 8 bits (required).
- Parity: Choose the parity according to the format chosen for communications on your Modbus network.
- Physical standard: RS485 (required).
- Stop bits: 1 or 2 bits.

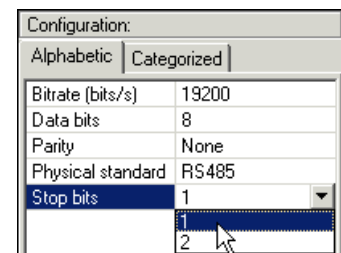
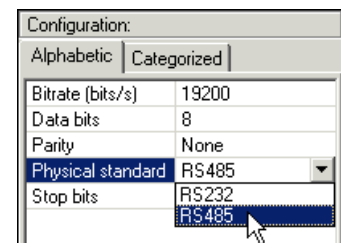
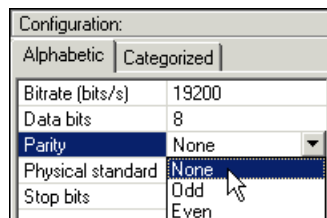
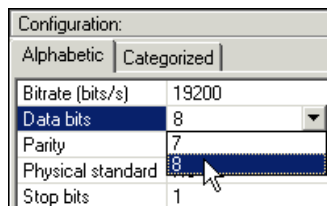
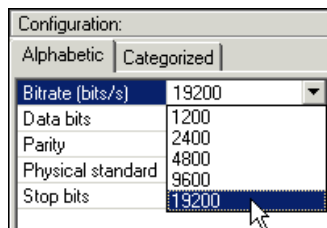

6. Configuring the Gateway

6.14. Adding a Broadcaster Node

A broadcaster node does not correspond to any Modbus slave in particular, as it applies to **all** Modbus slaves. All the commands which will be configured for this node will be transmitted with the “Slave Address” field set to 0x00. This means that all of the slaves will run the command, but that none of them will respond to it.

To add a broadcaster node, select “Sub-Network”, then choose “Add Broadcaster” from the “Sub-Network” menu. The broadcaster node created in this way does not count in the limit on the number of configurable nodes. A simple example is shown opposite:

The addition and configuration of a Modbus command in the list of broadcaster node commands is done in the same way as for other nodes, but with the following differences:

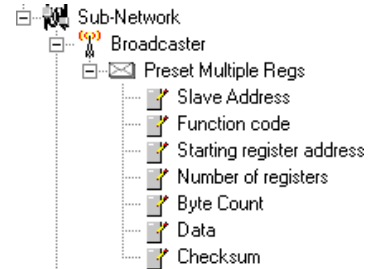

- The list of standard Modbus commands which can be used in broadcast is smaller. Only functions 0x06 and 0x10 can be used (see list in chapter 6.12.2).
- The command is made up of a query, but does not include any response. The query bears the name of the command itself, instead of the name “Query.” Also, each broadcast command only consumes one of the 100 queries and responses allowed by the gateway, as there is no possible response for such a command.
- The value of the query frame’s “Slave Address” field is set to 0x00.

Please see chapter 6.12.2.2, for further details on how to configure a Modbus query.

Appendix A: Technical Characteristics

Environment

Dimensions (excluding connectors)	Height: 120 mm (4.724 in.)	Width: 27 mm (1.063 in.)	Depth: 75 mm (2.953 in.)
External appearance	Plastic housing with snap-on connection to DIN-rail.		
Torque	PSU connector: between 5 and 7 lbs.-in (0.56 and 0.79 N-m).		
Power supply	<p>☐☐☐ 24V regulated ±10%</p> <p>Maximum consumption: 280 mA (typically around 100 mA)</p> <p>Maximum internal consumption for all of the gateway's electronic cards, relating to the internal 5V PSU: 450 mA</p>		
Protection class	IP20		
Maximum relative humidity	95% without condensation or seepage, according to IEC 68-2-30		
Ambient air temperature around the device, in a dry environment	<p>According to IEC 68-2-1 Ab, IEC 68-2-2 Bb and IEC 68-2-14 Nb:</p> <ul style="list-style-type: none"> • Storage: -55°C (±3) to +85°C (±2) (-72.4°F to -61.6°F) ... (+181°F to 189°F) • Operation: -5°C (±3) to +55°C (±2) (+17.6°F to 28.4°F) ... (+127°F to 135°F) 		
UL	E 214107 certificate "open type" category The product should be installed in an electrical cabinet or in an equivalent location.		
EC	Certified as complying with European standards, unless otherwise stated.		
Electromagnetic compatibility (EMC): Transmission	Complies with the EN 50 081-2:1993 (industrial environment) standard Tested according to class A radiation under the EN 55011:1990 standard		
Electromagnetic compatibility (EMC): Immunity	Complies with the EN 50 082-2:1995 and EN 61 000-6-2:1999 (industrial environment) standard Tested according to the ENV 50 204:1995, EN 61000-4-2:1995, EN 61000-4-3:1996, EN 61000-4-4:1995, EN 61000-4-5:1995 and EN 61000-4-6:1996 standards.		

Appendix A: Technical Characteristics

Communication Characteristics

"Upstream" network	Profibus-DP																								
"Downstream" network	Modbus RTU																								
Profibus-DP characteristics	<ul style="list-style-type: none"> • Transmission method: PROFIBUS DIN 19245 Part 1. • Nature of network: Device-oriented bus (DeviceBus). • Network topology: multipoint linear topology (bus) with adapted and active line terminations (see chapter 2.6.2). • Physical media: single twisted pair copper cable, shielded or not, preferably a type A Profibus-DP cable, with the following characteristics: <table style="margin-left: 20px; border: none;"> <tr> <td style="padding-right: 20px;">- Impedance..... 135 to 165 Ω (nominal value 150 Ω)</td> <td style="padding-right: 20px;">- Loop impedance110 Ω/km</td> </tr> <tr> <td style="padding-right: 20px;">- Capacity..... < 30 nF/km</td> <td style="padding-right: 20px;">- Conductor diameter0.64 mm</td> </tr> <tr> <td></td> <td style="padding-right: 20px;">- Conductor section.....> 0.34 mm²</td> </tr> </table> • Connections: 9-point SUB-D connectors, preferably (see chapter 2.6.2). • Communication speed: 9.6, 19.2, 45.45, 93.75, 187.5, 500, 1,500 or 12,000 kbits/s. • Maximum network length: the length of each segment (from one line termination to the other) is limited and depends upon the transmission rate. Using one, two, or three repeaters makes it possible to put such segments end to end; one can thus derive the maximum <i>total</i> length of the network, without changing the maximum length of each segment. <table style="margin-left: 20px; border: none; width: 100%;"> <thead> <tr> <th style="text-align: left;">Transmission rate</th> <th style="text-align: left;">Maximum segment length</th> <th style="text-align: left;">Max. network length (with the three repeaters)</th> </tr> </thead> <tbody> <tr> <td>Up to 93.75 kbits/s</td> <td>1,200 m (3,937 ft)</td> <td>4,800 m (15,748 ft)</td> </tr> <tr> <td>187.5 kbits/s</td> <td>1,000 m (3,281 ft)</td> <td>4,000 m (13,123 ft)</td> </tr> <tr> <td>500 kbits/s</td> <td>400 m (1,312 ft)</td> <td>2,000 m (6,567 ft)</td> </tr> <tr> <td>1,500 kbits/s</td> <td>200 m (656 ft)</td> <td>800 m (2,625 ft)</td> </tr> <tr> <td>12,000 kbits/s</td> <td>100 m (328 ft)</td> <td>400 m (1,312 ft)</td> </tr> </tbody> </table> 	- Impedance..... 135 to 165 Ω (nominal value 150 Ω)	- Loop impedance110 Ω/km	- Capacity..... < 30 nF/km	- Conductor diameter0.64 mm		- Conductor section.....> 0.34 mm ²	Transmission rate	Maximum segment length	Max. network length (with the three repeaters)	Up to 93.75 kbits/s	1,200 m (3,937 ft)	4,800 m (15,748 ft)	187.5 kbits/s	1,000 m (3,281 ft)	4,000 m (13,123 ft)	500 kbits/s	400 m (1,312 ft)	2,000 m (6,567 ft)	1,500 kbits/s	200 m (656 ft)	800 m (2,625 ft)	12,000 kbits/s	100 m (328 ft)	400 m (1,312 ft)
- Impedance..... 135 to 165 Ω (nominal value 150 Ω)	- Loop impedance110 Ω/km																								
- Capacity..... < 30 nF/km	- Conductor diameter0.64 mm																								
	- Conductor section.....> 0.34 mm ²																								
Transmission rate	Maximum segment length	Max. network length (with the three repeaters)																							
Up to 93.75 kbits/s	1,200 m (3,937 ft)	4,800 m (15,748 ft)																							
187.5 kbits/s	1,000 m (3,281 ft)	4,000 m (13,123 ft)																							
500 kbits/s	400 m (1,312 ft)	2,000 m (6,567 ft)																							
1,500 kbits/s	200 m (656 ft)	800 m (2,625 ft)																							
12,000 kbits/s	100 m (328 ft)	400 m (1,312 ft)																							
Profibus-DP characteristics (cont'd)	<ul style="list-style-type: none"> • Maximum number of stations: 32 stations per segment, repeater included; up to 126 stations with all three repeaters (repeaters included). Address 126 is reserved and should therefore not be used for exchanging data. • Possible types of stations: there are three types of Profibus-DP stations: <ul style="list-style-type: none"> - Class 1 DP master (DPM1): PLC, PC, etc. exchanging information with DP slaves. - Class 2 DP master (DPM2): A programming, bus configuring, or commissioning device, used to configure the Profibus-DP network upon commissioning and operation, or supervision. - DP slave: Peripheral device that exchanges data cyclically with the active DPM1 station to which it is linked. • Mono-master or multi-master network. • Hybrid access method: Acyclical communication between masters using the transfer of a token (synchronisation); cyclical master/slaves communications (application data transfers). • Up to 244 input bytes and 244 output bytes per DP slave; typical exchange of 32 bytes per slave. • Operating modes: Functional operations (cyclical I/O exchanges), resetting to zero (input reading and output resetting), or disruption (only inter-master functions are allowed). • Input (Freeze-Mode) and/or output (Sync-Mode) synchronisation of all DP slaves. • Other services offered: <ul style="list-style-type: none"> - Verification of DP slaves configuration. - Advanced diagnostics on three hierarchical levels. - Allocation of DP slaves addresses. - DP slaves provided with a watchdog triggering timeout. - Protection of DP slaves' access to I/O. • Possibility to connect or disconnect a station without impacting on communications between other stations. 																								

Appendix A: Technical Characteristics

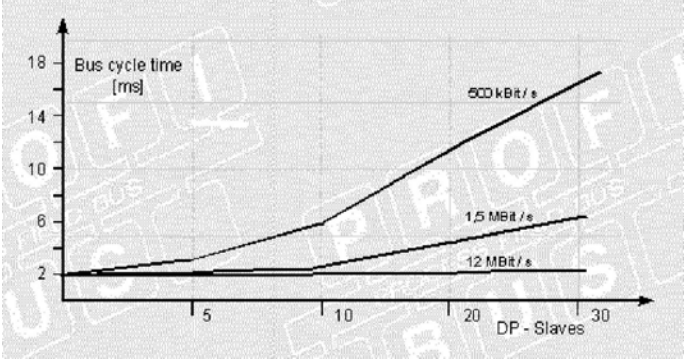
	<ul style="list-style-type: none"> Performance results: diagram presenting the bus cycle time of a mono-master Profibus-DP network, according to the number of DP slaves present on that network (with 2 input bytes and 2 output bytes per DP slave).  <p>Test conditions: minimum slave time interval = 200 μs; TSDI = 37 \times duration of one bit; TSDR = 11 \times duration of one bit.</p>
Profibus-DP LUF7 gateway specifics	<ul style="list-style-type: none"> Network type: PROFIBUS EN 50 170 (DIN 19245). Protocol version: v1.10. Standard connections: Female SUB-D 9-point connector, which is recommended for baud rates exceeding 1.5 Mbits/s. All baud rates supported (9.6, 19.2, 93.75, 187.5, 500, 1,500, 3,000, 6,000 and 12,000 kbits/s), automatic baud rate detection. "DP slave" Profibus-DP station. Cyclical data transmissions: up to 244 input bytes and 244 output bytes; 416 bytes exchanged maximum, inputs and outputs included; 24 modules maximum used to configure these I/O.

Appendix A: Technical Characteristics

Profibus-DP LUF7 gateway specifics (cont'd)	<ul style="list-style-type: none"> • Profibus-DP address configured using 2 coding wheels (address between 1 and 99); address 0 is not allowed. • Profibus-DP diagnostics service: Yes (standard 6-byte diagnostic). • "Resetting to zero" operating mode (input reading and output resetting to zero) not supported. • Input synchronisation (Freeze-Mode) and output synchronisation (Sync-Mode) supported. • Gateway address allocated by a master: Service not supported. • Configuration conducted using a specific GSD file. • DP-V1 extensions not supported (transmission of non-cyclical data). • Galvanic gateway insulation from the network; D(A) and D(B) signal insulation using opto-couplers.
Modbus RTU characteristics	<ul style="list-style-type: none"> • Physical media: RS485 serial link • Network topology: Multipoint linear topology with adapted line terminations (impedance of 120 Ω in parallel with a capacity of 1 nF) • Communication speed: 1,200 to 57,600 kbits/s • Data bits: 8 • Subscriber addresses: 1 to 247. Address 0 reserved for broadcasting. Addresses 65, 126 and 127 reserved if drivers and/or starters from <i>Schneider Electric</i> are used on the same Modbus network. • Period of silence: Equivalent to the transmission of 3.5 characters.

WARNING

USE OF RESERVED MODBUS ADDRESSES

Do not use Modbus addresses 65, 126, or 127 if a gateway's Modbus slaves will include a Schneider Electric Adjustable-Speed Drive System device such as an Altistart soft-starter or an Altivar motor drive. The Altistart and Altivar devices reserve these addresses for other communications, and the use of these addresses in such a system can have unintended consequences.

Failure to follow this instruction can result in death, serious injury, or equipment damage.

Specific Modbus RTU features of the LUF7 gateway	<ul style="list-style-type: none"> • Maximum number of subscribers (excluding gateway): 8 Modbus slaves. • Maximum number of commands configured: Up to 100 Modbus queries and responses configured for the same gateway using ABC-LUF7 Config Tool. • Communication speed: 1,200, 2,400, 4,800, 9,600, or 19,200 bits/s, configured using ABC-LUF7 Config Tool. • Period of silence: No possibility to raise the gateway's period of silence. • Parity: None, even or odd, configured using ABC-LUF7 Config Tool. • Start bits: 1 bit only. • Stop bits: 1 or 2 bits, configuration using ABC-LUF7 Config Tool.
--	---

Appendix A: Technical Characteristics

<p>Structure of the LUPF7 gateway's memory:</p> <p style="text-align: center;">Inputs</p>	<ul style="list-style-type: none"> • 2 bytes for the diagnostics of errors on the downstream network by the gateway (see chapter 5). • 242 bytes accessible by the Profibus-DP master in the form of input data (see Appendix C:, Input Data Memory Area paragraph, for default use of these input data). • 268 input bytes inaccessible by the Profibus-DP master due to the maximum number of input bytes that can be exchanged with the gateway (see chapter 4.2.6). <table border="1" style="width: 100%; border-collapse: collapse;"> <thead> <tr> <th style="text-align: left;">Addresses</th> <th style="text-align: center;">Input data area</th> </tr> </thead> <tbody> <tr> <td>0x0000 0x0001</td> <td style="text-align: center;">Gateway status word (unless "Control/Status Byte" = "Disabled")</td> </tr> <tr> <td>0x0002 : 0x00F3</td> <td style="text-align: center;">Inputs accessible by the Profibus-DP master (242 bytes)</td> </tr> <tr> <td>0x00F4 : 0x01FF</td> <td style="text-align: center;">Inputs inaccessible by the Profibus-DP master (268 bytes)</td> </tr> </tbody> </table>	Addresses	Input data area	0x0000 0x0001	Gateway status word (unless "Control/Status Byte" = "Disabled")	0x0002 : 0x00F3	Inputs accessible by the Profibus-DP master (242 bytes)	0x00F4 : 0x01FF	Inputs inaccessible by the Profibus-DP master (268 bytes)
Addresses	Input data area								
0x0000 0x0001	Gateway status word (unless "Control/Status Byte" = "Disabled")								
0x0002 : 0x00F3	Inputs accessible by the Profibus-DP master (242 bytes)								
0x00F4 : 0x01FF	Inputs inaccessible by the Profibus-DP master (268 bytes)								
<p>Structure of the LUPF7 gateway's memory:</p> <p style="text-align: center;">Outputs</p>	<ul style="list-style-type: none"> • 2 bytes for the activation or inhibition of the downstream network by the gateway (see chapter 5). • 242 bytes accessible by the Profibus-DP master in the form of output data (see Appendix C: Default Configuration, Output Data Memory Area, for default use of this output data). • 268 output bytes inaccessible by the Profibus-DP master due to the maximum number of output bytes that can be exchanged with the gateway (see chapter 4.2.6). <table border="1" style="width: 100%; border-collapse: collapse;"> <thead> <tr> <th style="text-align: left;">Addresses</th> <th style="text-align: center;">Output data area</th> </tr> </thead> <tbody> <tr> <td>0x0200 0x0201</td> <td style="text-align: center;">Profibus-DP master command word (except if "Control/Status Byte" = "Disabled")</td> </tr> <tr> <td>0x0202 : 0x02F3</td> <td style="text-align: center;">Outputs accessible by the Profibus-DP master (242 bytes)</td> </tr> <tr> <td>0x02F4 : 0x03FF</td> <td style="text-align: center;">Outputs inaccessible by the Profibus-DP master (268 bytes)</td> </tr> </tbody> </table>	Addresses	Output data area	0x0200 0x0201	Profibus-DP master command word (except if "Control/Status Byte" = "Disabled")	0x0202 : 0x02F3	Outputs accessible by the Profibus-DP master (242 bytes)	0x02F4 : 0x03FF	Outputs inaccessible by the Profibus-DP master (268 bytes)
Addresses	Output data area								
0x0200 0x0201	Profibus-DP master command word (except if "Control/Status Byte" = "Disabled")								
0x0202 : 0x02F3	Outputs accessible by the Profibus-DP master (242 bytes)								
0x02F4 : 0x03FF	Outputs inaccessible by the Profibus-DP master (268 bytes)								

Appendix A: Technical Characteristics

<p>Structure of the LUF7 gateway's memory:</p> <p>General data</p>	<ul style="list-style-type: none"> • 1,024 bytes inaccessible through the Profibus-DP master. <table border="1" data-bbox="532 239 1365 667"> <thead> <tr> <th data-bbox="532 239 683 268">Addresses</th> <th data-bbox="691 239 1365 268">General data area</th> </tr> </thead> <tbody> <tr> <td data-bbox="532 275 683 344">0x0400 0x051F</td> <td data-bbox="691 275 1365 344">Input area reserved for the Mailboxes (288 bytes)</td> </tr> <tr> <td data-bbox="532 350 683 420">0x0520 0x063F</td> <td data-bbox="691 350 1365 420">Output area reserved for the Mailboxes (288 bytes)</td> </tr> <tr> <td data-bbox="532 426 683 522">0x0640 : 0x07BF</td> <td data-bbox="691 426 1365 522">Internal area reserved for the management of the upstream network (384 bytes; area not used by the LUF7 gateway)</td> </tr> <tr> <td data-bbox="532 529 683 598">0x07C0 0x07FD</td> <td data-bbox="691 529 1365 598">Internal area reserved for the control registers (62 bytes / MSB first for 16-bit data)</td> </tr> <tr> <td data-bbox="532 604 683 667">0x07FE 0x07FF</td> <td data-bbox="691 604 1365 667">Gateway status / Profibus-DP master control (2 bytes)</td> </tr> </tbody> </table> <p>NOTE: You can use the general data area for Modbus input data (from Modbus responses) if you do not want the Profibus-DP master to have access to them. You can also use this memory area for data transfers between commands and/or transactions as this area is both an input <i>and</i> an output area. In this case, <i>always use 0x0400 as the starting address</i>. If you use multiple times the same addresses in this area, the corresponding memory locations will be displayed in red in the "General Area" section of the "Sub-network Monitor" window). However, this will have no consequences on the gateway during run-time.</p>	Addresses	General data area	0x0400 0x051F	Input area reserved for the Mailboxes (288 bytes)	0x0520 0x063F	Output area reserved for the Mailboxes (288 bytes)	0x0640 : 0x07BF	Internal area reserved for the management of the upstream network (384 bytes; area not used by the LUF7 gateway)	0x07C0 0x07FD	Internal area reserved for the control registers (62 bytes / MSB first for 16-bit data)	0x07FE 0x07FF	Gateway status / Profibus-DP master control (2 bytes)
Addresses	General data area												
0x0400 0x051F	Input area reserved for the Mailboxes (288 bytes)												
0x0520 0x063F	Output area reserved for the Mailboxes (288 bytes)												
0x0640 : 0x07BF	Internal area reserved for the management of the upstream network (384 bytes; area not used by the LUF7 gateway)												
0x07C0 0x07FD	Internal area reserved for the control registers (62 bytes / MSB first for 16-bit data)												
0x07FE 0x07FF	Gateway status / Profibus-DP master control (2 bytes)												
<p>Data transfer order (swapping)</p>	<ul style="list-style-type: none"> • Profibus-DP network: MSB first and LSB last. • Modbus RTU network: MSB first and LSB last. • LUF7 gateway MSB stored in the lowest memory address. <p>→ In most cases, the option which should be chosen for Modbus data stored in the gateway's memory is "No swapping". This option relates to all "Data", "Preset Data", and "Variable Data" fields for Modbus queries and responses frames.</p>												

Appendix B: LUF7 Gateway GSD File

The LUF7 gateway GSD file contains all the information and settings for configuring the gateway under Profibus-DP. This file, "Tele071F.gsd", is used by SyCon to generate information that will eventually be used by the DPM1 master PLC during setup phases.

Refer to chapter 4.2.4, to review the procedure for importing the GSD file under SyCon.

Identification Number

The most important information contained in the GSD file is the identification number "Ident_Number" of the device type it designates (DP slave or DPM1 master). This identification number is, in particular, used by a DPM1 master upon setting up its communications with a DP slave, in addition to checking its address on the Profibus-DP network.

The allocation of Profibus-DP identification numbers is reserved for the Profibus International (PI) association. As each identification number is unique and specific to each device type, you should change neither the number, nor the remainder of the provided GSD file. *Schneider Electric* reserves the rights to change the content of this file.

Sample Profibus-DP products, with their identification numbers and the related GSD files:

Schneider Electric product	Identification number	Name of the related GSD file
LUF7 gateway	0x071F	Tele071F.gsd
TEGO POWER	0xBECE	tk3110.gsd
ATV58	0x00B9	Tele00b9.gsd
ATV68	0x1234	VEE_1234.gsd
TSX PBY 100	0x1654	Sad_1654.gsd
ATV58/ATV66 gateway	0x2332	atvp2332.gsd

GSD File Content

```
=====
; Profibus Device Database of :
; Schneider Electric Gateways
; Model      : LUF7
; Description : Profibus-DP/Modbus Gateway
; Language   : English
; Date       : 14 November 2002
; Author     : Schneider Electric [EB/JFR]
;=====
#Profibus_DP
```

GSD file header.

```
GSD_Revision      = 2

; Device identification
Vendor_Name       = "Schneider Electric"
Model_Name        = "LUF7"
Revision          = "Version 1.0"
Ident_Number      = 0x071F
Protocol_Ident    = 0                ; DP protocol
Station_Type      = 0                ; Slave device
FMS_supp          = 0                ; FMS not supported
Hardware_Release  = "Version 1.41"
Software_Release  = "Version 1.12"
```

LUF7 gateway identification as a Profibus-DP device.

Appendix B: LUFP7 Gateway GSD File

<pre> ; Supported baudrates 9.6_supp = 1 19.2_supp = 1 45.45_supp = 1 93.75_supp = 1 187.5_supp = 1 500_supp = 1 1.5M_supp = 1 3M_supp = 1 6M_supp = 1 12M_supp = 1 </pre>	<p>Communication rates supported by the LUFP7 gateway.</p> <p>All rates should be mentioned in this section. The gateway supports all the baud rates of the Profibus-DP networks.</p>
<pre> ; Maximum responder time for supported baudrates MaxTsdr_9.6 = 60 MaxTsdr_19.2 = 60 MaxTsdr_45.45 = 60 MaxTsdr_93.75 = 60 MaxTsdr_187.5 = 60 MaxTsdr_500 = 100 MaxTsdr_1.5M = 150 MaxTsdr_3M = 250 MaxTsdr_6M = 450 MaxTsdr_12M = 800 </pre>	<p>Maximum response time of the gateway, depending on the baud rate of the Profibus-DP network.</p> <p>The response times specified for the gateway are standard values, compatible with the TSX PB100 coupler, for example.</p>
<pre> ; Supported hardware features Redundancy = 0 ; not supported Repeater_Ctrl_Sig = 2 ; TTL 24V_Pins = 0 ; not connected Implementation_Type = "SPC3" </pre>	<p>General hardware characteristics specific to Profibus-DP.</p>
<pre> ; Supported DP features Freeze_Mode_supp = 1 ; supported Sync_Mode_supp = 1 ; supported Auto_Baud_supp = 1 ; supported Set_Slave_Add_supp = 0 ; not supported </pre>	<p>Supported and not supported Profibus-DP services.</p>
<pre> ; Maximum polling frequency Min_Slave_Intervall = 1 ; 100 us </pre>	<p>Maximum polling frequency / Minimum polling interval</p> <p>100 μs is the smallest interval that can be configured.</p>
<pre> ; Maximum supported sizes Modular_Station = 1 ; modular Max_Module = 24 Max_Input_Len = 244 Max_Output_Len = 244 Max_Data_Len = 416 Modul_Offset = 1 </pre>	<p>The LUFP7 gateway is a modular Profibus-DP device, i.e. the size of its I/O exchanges on the Profibus-DP network is configured by combining several modules together (see below).</p>
<pre> Fail_Safe = 0 ; state CLEAR not accepted Slave_Family = 0 Max_Diag_Data_Len = 6 </pre>	<p>Supported and not supported Profibus-DP services (cont'd).</p> <p>The length of the gateway's diagnostic data should remain equal to 6.</p> <p>NOTE: There are no parameter data (the "User_Prm_Data_Len" and "User_Prm_Data" parameters are therefore omitted).</p>
<pre> Bitmap_Device = "LUFP7_R" Bitmap_Diag = "LUFP7_D" Bitmap_SF = "LUFP7_S" </pre>	<p>Names of the bitmap files used by SyCon to display the gateway's connection status.</p>
<pre> ; Definition of modules </pre>	<p>Beginning of the section where the modules used for configuring the sizes of the gateway inputs and outputs are defined.</p>

Appendix B: LUF7 Gateway GSD File

```
Module = "IN/OUT: 1 Byte" 0x30
EndModule
;
Module = "IN/OUT: 2 Byte ( 1 word)" 0x70
EndModule
;
Module = "IN/OUT: 4 Byte ( 2 word)" 0x71
EndModule
;
Module = "IN/OUT: 6 Byte ( 3 word)" 0x72
EndModule
;
Module = "IN/OUT: 8 Byte ( 4 word)" 0x73
EndModule
;
Module = "IN/OUT: 10 Byte ( 5 word)" 0x74
EndModule
;
Module = "IN/OUT: 12 Byte ( 6 word)" 0x75
EndModule
;
Module = "IN/OUT: 14 Byte ( 7 word)" 0x76
EndModule
;
Module = "IN/OUT: 16 Byte ( 8 word)" 0x77
EndModule
;
Module = "IN/OUT: 32 Byte (16 word)" 0x7F
EndModule
;
Module = "IN/OUT: 64 Byte (32 word)" 0xC0,0x5F,0x5F
EndModule
;
Module = "IN/OUT: 128 Byte (64 word)" 0xC0,0x7F,0x7F
EndModule
;
Module = "INPUT: 1 Byte" 0x10
EndModule
;
Module = "INPUT: 2 Byte ( 1 word)" 0x50
EndModule
;
Module = "INPUT: 4 Byte ( 2 word)" 0x51
EndModule
;
Module = "INPUT: 6 Byte ( 3 word)" 0x52
EndModule
;
Module = "INPUT: 8 Byte ( 4 word)" 0x53
EndModule
;
Module = "INPUT: 10 Byte ( 5 word)" 0x54
EndModule
;
Module = "INPUT: 12 Byte ( 6 word)" 0x55
EndModule
;
Module = "INPUT: 14 Byte ( 7 word)" 0x56
EndModule
;
Module = "INPUT: 16 Byte ( 8 word)" 0x57
EndModule
;
Module = "INPUT: 32 Byte (16 word)" 0x5F
EndModule
;
Module = "INPUT: 64 Byte (32 word)" 0x40,0x5F
EndModule
;
```

Definition of the "IN/OUT" (inputs size = outputs size), "INPUT", and "OUTPUT" modules.

Modularity: under SyCon, one can combine all three types of modules (I/O, inputs, and outputs), up to the maximum number of modules "Max_Module", the maximum number of input bytes "Max_Input_Len", the maximum number of output bytes "Max_Output_Len", and the total maximum number of input and output bytes "Max_Data_Len". **You must not exceed any of these four limits.**

Example 1: should the gateway exchange 83 input bytes and 33 output bytes, you could combine the following modules:

- INPUT: 64 Byte (32 word)
- INPUT: 16 Byte (8 word)
- INPUT: 2 Byte (1 word)
- INPUT: 1 Byte
- OUTPUT: 32 Byte (16 word)
- OUTPUT: 1 Byte

Example 2: should the gateway exchange 33 input bytes and 34 output bytes, you could use the following combination:

- IN/OUT: 32 Byte (16 word)
- INPUT: 1 Byte
- OUTPUT: 2 Byte (1 word)

Appendix B: LUF7 Gateway GSD File

```
Module = "INPUT: 128 Byte (64 word)" 0x40,0x7F
EndModule
;
Module = "OUTPUT: 1 Byte" 0x20
EndModule
;
Module = "OUTPUT: 2 Byte ( 1 word)" 0x60
EndModule
;
Module = "OUTPUT: 4 Byte ( 2 word)" 0x61
EndModule
;
Module = "OUTPUT: 6 Byte ( 3 word)" 0x62
EndModule
;
Module = "OUTPUT: 8 Byte ( 4 word)" 0x63
EndModule
;
Module = "OUTPUT: 10 Byte ( 5 word)" 0x64
EndModule
;
Module = "OUTPUT: 12 Byte ( 6 word)" 0x65
EndModule
;
Module = "OUTPUT: 14 Byte ( 7 word)" 0x64
EndModule
;
Module = "OUTPUT: 16 Byte ( 8 word)" 0x67
EndModule
;
Module = "OUTPUT: 32 Byte (16 word)" 0x6F
EndModule
;
Module = "OUTPUT: 64 Byte (32 word)" 0x80,0x5F
EndModule
;
Module = "OUTPUT: 128 Byte (64 word)" 0x80,0x7F
EndModule
```

Appendix C: Default Configuration

The configuration described below corresponds to the LUF7 gateway's default configuration.

NOTE: This chapter mainly gives the user information about the performance obtained on the downstream Modbus network. It allows the user to decide whether, for example, he should change the period for cyclical exchanges with one or more of the TeSys U motor starters (see chapter 6).

Configuring Modbus Exchanges

The LUF7 gateway carries out four types of exchanges with each of the 8 TeSys U motor starters. The first two exchanges are cyclical and allow you to control and monitor the motor starter. The last two exchanges are aperiodic (only when there is a change in the values of the data to be transmitted to the motor starter) and allow you to read and change the value of any motor starter parameter.

Function	Modbus function	Number of bytes (1)	Exchange between the LUF7 gateway and the TeSys U motor starter
0x03	Read Holding Registers	11,5 + 10,5	Periodic reading (300 ms period) of the TeSys U motor starter's status register (address 455 = 0x01C7) only
0x10	Preset Multiple Registers	14,5 + 11,5	Periodic writing (300 ms period) of the TeSys U motor starter's status register (address 704 = 0x02C0) only
(0x03)	(Read Holding Register)	11,5 + 10,5	Aperiodic reading of the value of a single parameter, for a single TeSys U motor starter at a time (function and address supplied by the user)
(0x06)	(Preset Single Register)	11,5 + 11,5	Aperiodic writing of the value of a single parameter, for a single TeSys U motor starter at a time (function and address and value supplied by the user)

- (1) Number of bytes in the Query + number of bytes in the Response, plus a period of silence of 3.5 characters for each of these two frames. Each byte will be transmitted in the form of a group of 10 bits (8 data bits, 1 start bit and 1 stop bit). These values allow you to calculate the approximate amount of traffic on the downstream Modbus network as follows:

Volume of periodic traffic (300 ms period)..... $[(11.5 + 10.5) + (14.5 + 11.5)] \times (8 + 1 + 1) = 480 \text{ bits}$

For 1 TeSys U motor starter $1 \times 480 \times (1,000 \div 300) = 1,600 \text{ bits/s}$

For 8 TeSys U motor starters $8 \times 480 \times (1,000 \div 300) = 12,800 \text{ bits/s}$

As a result, on a network operating at 9,600 bits/s, you will need to considerably increase the cycle time for all or part of the periodic Modbus commands. On the other hand, at a speed of 19,200 bits/s (default speed), the available bandwidth is sufficient to allow proper communications, even in occasional degraded mode (frames re-transmission), and to allow the use of aperiodic parameter reading/writing exchanges.

Appendix C: Default Configuration

Content of the Gateway's DPRAM Memory

The LUF7 gateway's DPRAM memory contains all of the data exchanged between the gateway and the 8 TeSys U motor starters, as well as two special registers only exchanged between the gateway and the Profibus-DP master (words used for managing the downstream Modbus network).

The flow of data exchanged between the TeSys U motor starters, the gateway and the Profibus-DP master is shown below, in order to highlight the role of the gateway's memory in these exchanges:

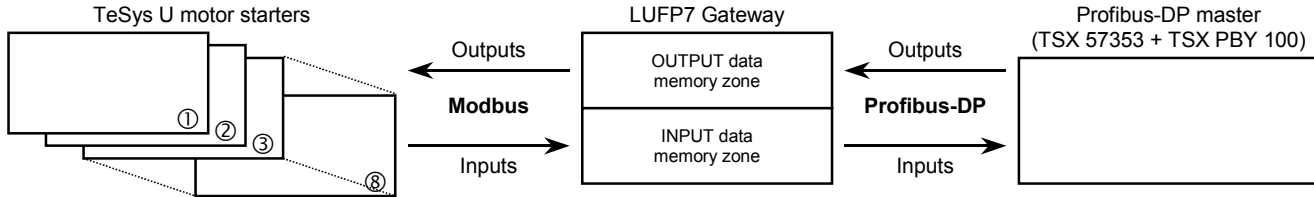

NOTE: The total number of input and output bytes should be less than or equal to 416 bytes. It is therefore not possible to configure both the maximum number of input bytes and the maximum number of output bytes, which are both equal to 244 bytes.

Input Data Memory Area

The gateway has 244 input bytes. Only the first 32 bytes are used. Byte 0x0012 is used for adjusting the following 16-bit data, so that they can be aligned on even addresses, and for obtaining a total size of 32 input bytes. One should therefore configure only one 32-byte input/output module using a Profibus-DP configuration device such as SyCon.

Service	Address	Size	Description
Managing the downstream Modbus network	0x0000	1 word	Gateway status word
Periodic communications — Monitoring of TeSys U motor starters	0x0002	1 word	Value of the motor starter ① status register
	0x0004	1 word	Value of the motor starter ② status register
	0x0006	1 word	Value of the motor starter ③ status register
	0x0008	1 word	Value of the motor starter ④ status register
	0x000A	1 word	Value of the motor starter ⑤ status register
	0x000C	1 word	Value of the motor starter ⑥ status register
	0x000E	1 word	Value of the motor starter ⑦ status register
	0x0010	1 word	Value of the motor starter ⑧ status register
—	0x0012	1 byte	Free memory location
Aperiodic communications — Reading the value of a motor starter parameter (RESPONSE)	0x0013	1 byte	Slave no. (0x01 to 0x08)
	0x0014	1 byte	Function number (0x03)
	0x0015	1 byte	Number of bytes read (0x02)
	0x0016	1 word	Value of the parameter read (0xxxxx)
Aperiodic communications — Writing the value of a motor starter parameter (RESPONSE)	0x0018	1 byte	Slave no. (0x01 to 0x08)
	0x0019	1 byte	Function number (0x06)
	0x001A	1 word	Address of the parameter written (0xxxxx)
	0x001C	1 word	Value of the parameter written (0xxxxx)
Aperiodic communications ("Trigger bytes" for the responses)	0x001E	1 byte	Read parameter response counter
	0x001F	1 byte	Write parameter response counter
—	0x0020 ... 0x00F3	1 byte ... 1 byte	Free input area (212 bytes)
—	0x00F4 ... 0x01FF	1 byte ... 1 byte	Unusable input area (268 bytes)

Appendix C: Default Configuration

Output Data Memory Area

The gateway has 244 output bytes. Only the first 32 bytes are used. One should therefore configure only one 32-byte input/output module using a Profibus-DP configuration device such as SyCon.

Service	Address	Size	Description
Managing the downstream Modbus network	0x0200	1 word	Profibus-DP master command word
Periodic communications — Controlling TeSys U motor starters	0x0202	1 word	Value of the motor starter ① command register
	0x0204	1 word	Value of the motor starter ② command register
	0x0206	1 word	Value of the motor starter ③ command register
	0x0208	1 word	Value of the motor starter ④ command register
	0x020A	1 word	Value of the motor starter ⑤ command register
	0x020C	1 word	Value of the motor starter ⑥ command register
	0x020E	1 word	Value of the motor starter ⑦ command register
	0x0210	1 word	Value of the motor starter ⑧ command register
Aperiodic communications — Reading the value of a motor starter parameter (QUERY)	0x0212	1 byte	Slave no. (0x01 to 0x08)
	0x0213	1 byte	Function number (0x03)
	0x0214	1 word	Address of the parameter to be read (0xxxxx)
	0x0216	1 word	Number of parameters to be read (0x0001)
Aperiodic communications — Writing the value of a motor starter parameter (QUERY)	0x0218	1 byte	Slave no. (0x01 to 0x08)
	0x0219	1 byte	Function number (0x06)
	0x021A	1 word	Address of the parameter to be written (0xxxxx)
	0x021C	1 word	Value of the parameter to be written (0xxxxx)
Aperiodic communications ("Trigger bytes" for the queries)	0x021E	1 byte	Read parameter query counter
	0x021F	1 byte	Write parameter query counter
—	0x0220 ... 0x02F3	1 byte ... 1 byte	Free output area (212 bytes)
—	0x02F4 ... 0x03FF	1 byte ... 1 byte	Unusable output area (268 bytes)

Total Number of Modbus Queries and Responses

The total number of Modbus queries and responses is equal to 36 (2 periodic queries and 2 periodic responses for each of the 8 TeSys U motor starters, plus 2 aperiodic queries and 2 aperiodic responses for all of these motor starters). Since the total number of the Modbus queries and responses one can configure for a single gateway is limited to 100, there are 64 spare Modbus queries and responses (that is to say the equivalent of 32 Modbus commands).

So, this reserve allows the addition of up to 4 Modbus commands for each one of the 8 TeSys U motor starters, as this would require the use of 64 Modbus queries and responses (4 times 1 query and 1 response for each of the 8 motor starters; *i.e.* $4 \times (1+1) \times 8$).

Appendix D: Sample Use under PL7 PRO

A practical example can be found on the <http://www.telemecanique.com> website. It is composed of four files.



- The first file, “LUF7_Tutorial_EN.pb”, is a SyCon file for a Profibus-DP network. It therefore represents the configuration of the Profibus-DP network, as it is described in the previous chapters. This file is useful only if you wish to change the configuration.
- The second file, “LUF7EN.cnf”, is the configuration file exported in ASCII format from SyCon. It corresponds to the configuration defined in the previous file. You must therefore generate a new “.cnf” file if you change the first file or use another “.pb” file.









The “LUF7EN.cnf” file should be copied to the “C:\PL7USER\” directory. If you copy it to another directory, you should specify its location, under PL7 PRO, using the “Load CNF” button available in the TSX PBY 100 board configuration screen.

- The third and fourth file, “lufp7_tutorial_EN_tsx57353.stx” and “lufp7_tutorial_EN_tsx57202.stx”, are PL7 PRO files and therefore represents the actual example for a TSX Premium PLC with respectively a TSX57353 processor and TSX57202 processor. The next chapters deal with its content and the way to use those files.

The configuration of the two SyCon files corresponds exactly to what is described in the previous chapters. Therefore, their content is not detailed here. However, the PL7 PRO file is described below, based on the structure of the program sections used and the related operating screens.

Overview of the “LUF7 - Tutorial Example”

In this example, the various program sections and sub-programs (icon ) and also the operations screens (icon ) are organized as follows:

- LUF7 gateway initialization and diagnostics:
 -  Handshake_lufp7
 -  Handshake_master
 -  LUF7 Gateway Exchanges
- Control and supervision screen for the 8 TeSys U motor starters:
 -  Cmde_mon
 -  Sr0
 -  Supervision Control
- Reading and writing of any TeSys U motor starter parameter (service similar to the “parameter area PKW”):
 -  Pkw_service
 -  PKW Service

Each of the groupings presented above is described in an independent chapter.

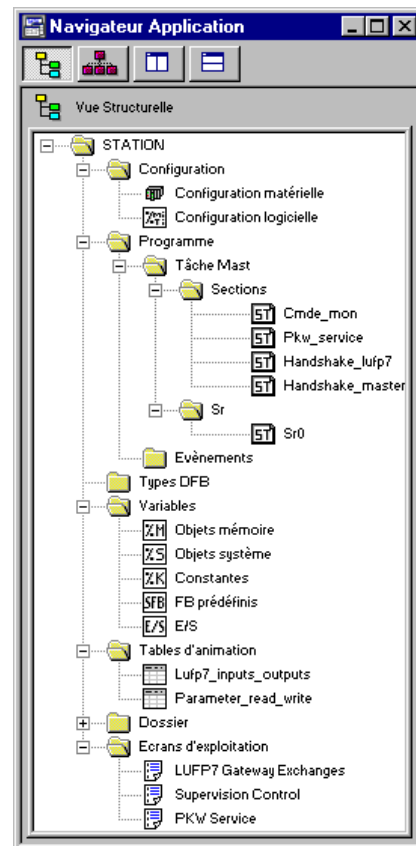

Appendix D: Sample Use under PL7 PRO

This description remains concise, because it is only meant to describe the overall operation of the program and the way to use the related screen. If you need further detail, review the actual content of the example under PL7 PRO.

The source code has comments to help you understand how this works. Each "program" file starts with a short description of the way it operates; each line includes a comment.

Each variable used has a symbol whose name describes its use. Use keyboard shortcuts "Ctrl+E" and "Ctrl+F" to display the variables by addresses (e.g. %MW80) or by symbols (e.g. Pkw_checked_boxes_slave).

Two animation tables (icon) have been created, "Lufp7_inputs_outputs" and "Parameter_read_write." The first animation table presents the I/O that correspond to the exchanges with the LUF7 gateway, i.e. %IW4.0 to %IW4.0.15 and %QW4.0 to %QW4.0.15. The second table presents the I/O related to the aperiodic service for reading/writing the value of any motor starter parameter, and also some local variables used by this service. In the context of this example, this service is also called "PKW" due to its limited similarity with the PKW service implemented on a few other products from *Schneider Electric*.

NOTE: This service was not implemented the same way as the PKW service and must therefore not be used identically.

Gateway Initialization and Diagnostics

The "LUF7 gateway exchanges" operating screen comprises four separate sections:

- Hexadecimal display of gateway input data (%IW4.0 to %IW4.0.15) in the **INPUTS** frame. These inputs are named and grouped in the same manner as in this guide (see chapter 4.2.9). Of course, the display of these input data is correct only if the gateway default configuration is used.

For **INPUTS**: A green/red LED indicates whether the various input data have already been updated by the gateway. It is associated to bit 13 (ABC_DU) of the gateway status word.

NOTE: This input data includes periodic Modbus data (controlling and monitoring) and aperiodic Modbus data (parameter reading/writing). For the LED to turn green, both parameter read and write commands must have received a response from a Modbus slave.

A second green/red LED indicates whether the input data are updated on a periodic basis or not by the gateway, i.e. if periodic exchanges take place properly with all Modbus slaves. It is associated to bit 12 of the gateway status word. Unlike the first LED, only one Modbus command per slave should receive a response on a periodic basis for this LED to remain green.

- Hexadecimal display of gateway output data (%QW4.0 to %QW4.0.15) in the **OUTPUTS** frame.

For **OUTPUTS**: The green/red LED indicates whether the Profibus-DP master wants the gateway to communicate with the Modbus slaves. It is associated to bit 13 (FB_DU) of the Profibus-DP master command word, which is updated in the "Handshake_master" program, in accordance with the user controls described below.

- User controls for enabling / disabling exchanges on the gateway Modbus sub-network. These two exclusive buttons are meant to switch the value of bit 13 (FB_DU) of the Profibus-DP master command word and to generate a new control meant for the gateway (see "Handshake_master" program description and chapter 5.2.1).

Appendix D: Sample Use under PL7 PRO

- Comprehensive display of LUF7 gateway diagnostics, via a thorough interpretation of the gateway status word (see chapter 5.2.2). This interpretation is made in the program “Handshake_lufp7”.

A button appears as soon as a new diagnostic is made available by the gateway for the Profibus-DP master. Pressing that button takes the new value of the gateway status word into account and acknowledges the new diagnostic.

The “**Handshake_master**” program assists the screen presented on the previous page in conducting the following tasks:

- Display of two buttons meant for enabling and disabling exchanges on the gateway Modbus sub-network.
- Transmission (to the gateway) of the command related to the button pressed by the user. This is done only once the gateway acknowledges the previous command, i.e. once bit 14 of the gateway status word has the same value as bit 14 of the Profibus-DP master command word.

In that case, bit 13 of the Profibus-DP master command word is updated in accordance with the user command, and the value of its bit 14 is inverted to notify the gateway of the presence of a new command.

NOTE: The LED, the two buttons, and the related processings, should not be used with the gateway default configuration as the choice retained for the “Control/Status Byte” option is “Enabled but no startup lock” (see chapter 5 and chapter 5.2). These elements are therefore only meant to make this example compatible with the “Enabled” option (see chapter 5.1).

The “**Handshake_lufp7**” program also assists the screen described on the previous page in conducting the following tasks:

- Display the button meant to take the content of the gateway status word into account. This button is displayed only if a new diagnostic is available, i.e. if the value of bit 15 of the gateway status word is different from that of bit 15 of the Profibus-DP master command word.
- When the user presses that button, the content of the gateway status word is analyzed in order to generate four separate messages according to the following data: gateway input data update/validity (bit 13), periodicity of Modbus exchanges (bit 12), error code (bits 8-11) and unit/nature of the data element related to the error code (bits 0-7).

Bit 15 of the Profibus-DP master command word is then set to the same value as bit 15 of the gateway status word to notify the gateway that the diagnostic has been taken into account and it can therefore deliver a new one.

Appendix D: Sample Use under PL7 PRO

Controlling and Supervising the 8 TeSys U Motor Starters

The “**Supervision Control**” operating screen (see picture below) is meant to monitor the status of the 8 TeSys U motor starters, numbered from 1 to 8. It is also meant to control them individually using several buttons.

Registers 455 and 704 of each of the 8 TeSys U motor starters are used to conduct this control and supervision:

455 – TeSys U status register (IEC61915)

- Bit 0 Motor starter ready
- Bit 1 Contactor in the ON position (**1**)
- Bit 2 Fault (*trip* or *dropout*)
- Bit 3 Alarm presence
- Bit 4 Specific: *Tripped* (**I>>**)
- Bit 5 Specific: Fault reset authorized
- Bit 6 Specific: A1-A2 supply
- Bit 7 Specific: Motor running
- Bits 8-13 ... Motor current (2#10 0000 = 200%)
- Bit 14 Reserved: Local control
- Bit 15 Ramping (motor starting)

704 – (IEC61915) command register

- Bit 0 Reserved: Run forward
- Bit 1 Reserved: Run reverse
- Bit 2 Reserved (stopping)
- Bit 3 Reset
- Bit 4 Reserved (emergency start)
- Bit 5 Self test: Triggering test (*trip*)
- Bit 6 Reserved (low speed)
- Bits 7-11 ... Reserved by the IEC61915 standard
- Bit 12 Specific: Overload (*shunt trip*)
- Bit 13 Specific: Pause (reserved for adjustment)
- Bits 14-15 .Specific: Reserved

These statuses and controls are grouped in two sections: “General Status”, for the general operating mode of the motor starters, and “Motor” for the general operating mode of controlled motors. The last section, “DEBUG COMM.”, displays the registers %IW and %QW used for each motor starter.

This screen is represented below, but only for the first motor starter, as it is identical for the 7 others.

Most displays in this operating screen are directly tied to the %MW registers containing the values of registers %IW4.0.1 to %IW4.0.8 and %QW4.0.1 to %QW4.0.8 (status and command registers of the TeSys U motor starters). Only the indirect controls and statuses are described below.

The “**Cmd_mon**” program conducts the following tasks:

- Copy the values of words %MW20 to %MW27 to output registers %QW4.0.1 to %QW4.0.8, and copy the values of input registers %IW4.0.1 to %IW4.0.8 to words %MW10 to %MW17.

These data are copied because word bit extraction can be carried out on %MW indexed words, but not on %IW indexed words. Actually, the sub-program “**Sr0**” uses word indexing to a large extent, as it makes it possible to process any motor starter, since it is designated by the word %MW0. *E.g.*: “%MW10[%MW0]:X13” is allowed, but not “%IW4.0.1[%MW0]:X13”.

Furthermore, the input and output words are copied one by one, as PL7 PRO does not support expressions such as “%IW4.0.1:8”.

- “**Sr0**” sub-program calling loop, whose purpose is to control and monitor of the 8 TeSys U motor starters. Upon each iteration of this loop, the word %MW0 (“Module”) takes a value from 0 to 7 in order to be used as an index for words %MW10 to %MW17 (inputs) and %MW20 to %MW27 (outputs).

TeSys U	n°1
General Status	1
Ready — ON	<input type="checkbox"/> <input type="checkbox"/>
PAUSE — Start	[
— Stop]
Alarm — Fault	<input type="checkbox"/> <input type="checkbox"/>
? Fault reset ?	NON
Fault reset	
Tripped	<input type="checkbox"/>
Shunt Trip	SHUNT
Test Trip	TEST
MOTOR	
Motor current	2
Motor current (%)	6.25
Run Forward	FOR
Run Reverse	REV
Stopping	STOP
DEBUG COMM.	
TeSys U command	16#0001
TeSys U status	16#02C3

Appendix D: Sample Use under PL7 PRO

The “**Sr0**” sub-program is called once per motor starter from the “**Cmd_mon**” program. Each of these calls should be made with a different value in the word %MW0 (between 0 and 7) as it is used to index the status word and the command word of the same motor starter. The sub-program assists the screen presented on the previous page in conducting the following tasks:

- Determine the overall status of the motor starter with: **I>>** in case of triggering (*tripped*), **1** if the contactor on the motor starter is in the ON position, or **0** in all other cases.
- Use the commands generated by buttons **START** and **STOP** to set the motor starter in off-pause or in pause mode (bit 13 of the command word).

NOTE: The "pause" mode should not be used for a normal application; you should rather use the **FOR**, **REV** and **STOP** buttons (see below).

- Activate the fault reset command (bit 3 of the command word) if the user pressed the **RAZ** button and the fault LED is on: . Once this command is on, it is cancelled as soon as the LED goes off: .
- Activate the self test command (*trip*) of the motor starter (bit 5 of the command word) if the user pressed the **TEST** button and the “Tripped” LED is off: . Once the command is on, it is cancelled as soon as the LED goes on: .
- Evaluate the value of the motor current, given as a percentage of the IR current value (unit = % FLA). Bits 8 (LSB) to 13 (MSB) of the motor starter status word are extracted and the appropriate unit (.e. 3,125% FLA), is then used to evaluate the current. The maximum value is therefore equal to 63, i.e. 196,875% FLA.
- Use buttons **FOR**, **REV** and **STOP** exclusively to enable only one of the three following controls at a time, while resetting the other two to zero, in descending priority order: stopping (bit 2 of the command word), run forward (bit 0), and run reverse (bit 1).

Reading and Writing any TeSys U Motor Starter Parameter

NOTE:

- Although the term “PKW” is used in the current example, the service for which an example is described here should not be confused with the PKW service of other products from *Schneider Electric*. These two services are different but can also be compared due to their main purpose, which consists in reading/writing the value of any parameter on any Modbus slave.
- However, contrary to the true PKW service, the aperiodic parameter reading/writing service used here does not support the Modbus broadcast feature (i.e. *do not ever use* address 0 to access all Modbus slaves at the same time). In addition, the internal settings of the LUF7 gateway cannot be accessed using this service.

Appendix D: Sample Use under PL7 PRO

The “**PKW Service**” operation screen allows the user to issue the reading or the writing of a register on any Modbus slave (mainly one of the 8 TeSys U motor starters from the default configuration). This screen is subdivided into a number of frames, described and displayed hereafter:

- The first frame, “Slave Address,” is used to select the station the aperiodic parameter reading/writing service will poll. Only one box can be checked at any given time. Depending on the box currently checked when the “SEND command” button is being pushed, the “Slave” field of the reading (MSB of %QW4.0.9) *or* writing (MSB of %QW4.0.12) command will be updated accordingly. The “Other address:” box allows the user to type in an address ranging from 1 to 247.

Slave Address <input type="checkbox"/> TeSys U n°1 motor starter <input type="checkbox"/> TeSys U n°2 motor starter <input checked="" type="checkbox"/> TeSys U n°3 motor starter <input type="checkbox"/> TeSys U n°4 motor starter <input type="checkbox"/> TeSys U n°5 motor starter <input type="checkbox"/> TeSys U n°6 motor starter <input type="checkbox"/> TeSys U n°7 motor starter <input type="checkbox"/> TeSys U n°8 motor starter <input type="checkbox"/> Other address: <input type="text" value="0"/>	Parameter Address <input type="text" value="455"/> Value for WRITING <input type="text" value="0"/> Command <input checked="" type="checkbox"/> Parameter Reading <input type="checkbox"/> Parameter Writing SEND command
---	--

- The second frame, “Parameter Address,” allows you to set the address of the parameter to read/write. When the “SEND command” button is being pushed, the value currently set in this frame is copied into the “Read parameter address” field of the reading command (%QW4.0.10) *or* into the “Written parameter address” field of the writing command (%QW4.0.13).
- The third frame, “Value for WRITING,” will only be used if the “Parameter Writing” command is to be issued. The transfer of any value set in this frame into the “Written parameter value” field of the writing command (%QW4.0.14) is done whenever the “SEND command” button is being pushed, provided the “Parameter Writing” box is checked.
- The fourth frame, “Command,” allows you to select the command that will be issued for the aperiodic parameter reading/writing service: read command or write command. Only one box can be checked at any given time.
- The “SEND command” button triggers the update of the gateway’s *periodic* output data (%QW4.0.9 à %QW4.0.14) in such a way that the gateway will issue the command that matches the settings and values from the frames previously described. The reading command is issued using the %QW4.0.9 to %QW4.0.11 outputs and the writing command is issued using the %QW4.0.12 to %QW4.0.14 outputs. All these updates are performed in the “**Pkw_service**” program. A new command is issued and sent each time a modification is brought to the value of the MSB byte (for reading) or to the value of the LSB byte (for writing) of the %QW4.0.15 output.

E.g. In the example displayed above, the frames are used to issue a command intended to read (0x03, i.e. the function code that stands for the “Read Holding Registers” Modbus function) the value of the register no. 455 (address = 0x01C7) on the TeSys U motor starter no. 3 (0x03). The number of read parameters is necessarily equal to 1 (0x0001), but this data is still updated by the “**Pkw_service**” program because it is part of the Modbus command frame the gateway will issue.

Appendix D: Sample Use under PL7 PRO

- The next four frames, located beneath and apart from the other ones, are intended to display the output data, transmitted to the gateway so that it will issue the corresponding Modbus query, the input data, as received by the gateway from one of its Modbus slaves in response to this query, the counters used by the gateway to trigger the emission of a command, and the counters updated by the gateway in order to mark the reception of a response. The upper frame is dedicated to the reading command (%QW4.0.9 to %QW4.0.11 for the query sent by the gateway and %IW4.0.9 to %IW4.0.11 for the response sent back by the Modbus slave) and the middle frame is dedicated to the writing command (%QW4.0.12 to %QW4.0.14 for the query sent by the gateway and %IW4.0.12 to %IW4.0.14 for the response sent back by the Modbus slave). Finally, the lowest two frames display the counters (or "Trigger bytes") associated to these queries and responses. The queries counters are transmitted to the gateway using the %QW4.0.15 output, whereas the responses counters are read using the %IW4.0.15 input. The contents of these two words is broken down in order to isolate the values of these 8-bit counters.

The example below follows the previously described example, as the output and input data for the aperiodic parameter reading/writing service match the settings and values of the other frames. Here, the value of the parameter is equal to 0x02C3. The middle frame has no valid data because the gateway has not yet been requested by the Profibus-DP master to send any write command.

READING the value of a parameter			
Query (LUPF7 Outputs)		Response (LUPF7 Inputs)	
Slave (MSB) + Function (LSB)	16#0303	Slave (LSB)	16#0003
Read parameter address	16#01C7	Function(MSB)+Number of bytes(LSB)	16#0302
Number of read parameters	16#0001	Read parameter value	16#02C3

WRITING the value of a parameter			
Query (LUPF7 Outputs)		Response (LUPF7 Inputs)	
Slave (MSB) + Function (LSB)	16#0000	Slave (MSB) + Function (LSB)	16#0000
Written parameter address	16#0000	Written parameter address	16#0000
Written parameter value	16#0000	Written parameter value	16#0000

Queries counters		Responses counters	
Read counter (MSB)	1	Read counter (MSB)	1
Write counter (LSB)	0	Write counter (LSB)	0

The "Pkw_service" program includes the ST instructions that use the settings and values from the first frames of the previously described "PKW Service" operation screen. These instructions are mainly designed to update the PLC outputs that relate to the commands of the aperiodic parameter reading/writing service (%QW4.0.9 to %QW4.0.11 for the read command, %QW4.0.12 to %QW4.0.14 for the write command, and %QW4.0.15 for the counters associated to these two commands). This program processes the following tasks:

- Test of all the checkboxes from the "Slave" and "Command" parts of the screen. If none of the boxes from each of these two parts is currently checked, one of them will be checked by default (Slave = TeSys U no. 1; Command = Parameter Reading).
- Comparison of the values that correspond to these checkboxes over two consecutive PLC cycles in order to keep only one checked box at any given time in each part.
- When the "SEND command" button is detected as being pushed, this program first updates some local variables, then updates the outputs that relate to the aperiodic parameter reading/writing service. This two-times update procedure is intended to cut off the outputs update from the rest of the program. The output data of the gateway are update on a conditional basis:

Appendix D: Sample Use under PL7 PRO

- **Parameter Reading** → Updates the %QW4.0.9 to %QW4.0.11 outputs in order for the gateway to issue the corresponding Modbus reading query (data displayed in the “Query (LUFP7 Outputs)” part of the “READING of a parameter value” frame). An 8-bit local counter is incremented each time a new query is issued (the 0 value being reserved, it will be replaced with 1), then transmitted to the gateway using the MSB byte of the %QW4.0.15 output.

The response from the polled slave will then be used by the gateway in order to update the %IW4.0.9 to %IW4.0.11 inputs (data displayed in the “Response (LUFP7 Inputs)” part of the “READING of a parameter value” frame). Each time such a response is received, the gateway increments the MSB byte of the %IW4.0.15 input in order to tell the Profibus-DP master that it has received a new response. This 8-bit counter is not used in this example.

- **Parameter Writing** → Updates the %QW4.0.12 to %QW4.0.14 outputs in order for the gateway to issue the corresponding Modbus writing query (data displayed in the “Query (LUFP7 Outputs)” part of the “WRITING of a parameter value” frame). An 8-bit local counter is incremented each time a new query is issued (the 0 value being reserved, it will be replaced with 1), then transmitted to the gateway using the LSB byte of the %QW4.0.15 output.

The response from the polled slave will then be used by the gateway in order to update the %IW4.0.12 to %IW4.0.14 inputs (data displayed in the “Response (LUFP7 Inputs)” part of the “WRITING of a parameter value” frame). Each time such a response is received, the gateway increments the LSB byte of the %IW4.0.15 input in order to tell the Profibus-DP master that it has received a new response. This 8-bit counter is not used in this example.

Appendix E: Profibus-DP Data and Diagnostics

The various elements presented here are detailed in the documentation of the Profibus-DP master you will have to use. In the case of the TSX PBV 100 coupler of the Premium automatic controls, for example, these elements are detailed in the *Implementation Manual – TSX PBV 100 – PROFIBUS-DP* (ref.: TSX DM PBV 100E), and in the PL7 PRO on line help (help path: Communication → Profibus-DP).

However, the most important elements are reproduced here in order to make the LUF7 gateway easier to use.

Gateway Profibus-DP Diagnostics

These diagnostics are the gateway's response to a specific command generated by a Profibus-DP master. This command enables the master to check the status of one of its slaves.

In the case of the LUF7 gateway, the response length is equal to 6 bytes, i.e. the minimum standard and mandatory length for a response to a diagnostic command.

Under PL7 PRO, this response can be viewed in two different ways:

- In the “Debug” screen of the TSX PBV 100 coupler, when the slave whose address corresponds to the gateway's is selected. The gateway Profibus-DP diagnostics are then displayed in the “PROFIBUS-DP diagnostic data”. An example is given on the right. It is an excerpt from the screen represented in chapter 4.2.12.

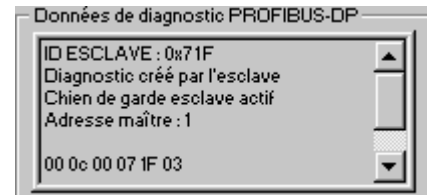

- Using the SEND_REQ function, the 0x0031 command code, and requesting specifically a diagnostic from the slave concerned.

The table below describes the structure and content of the gateway response to a Profibus-DP diagnostic command sent to it:

Bytes	Structure	Description
0	x0: not_reachable x1: not_ready x2: config_fault x3: ext_diag x4: not_supported x5: invalid_rsp x6: param_fault x7: master_lock	x0=1 if the slave is non connected or switched off x1=1 if the slave is not ready for data exchange x2=1 if there is a slave configuration error upon test request x3=1 if extended diagnostic (bytes 7-255); x3=0 for the LUF7 gateway x4=1 if the function is not supported by the slave x5=1 if there is an error in the slave's first response x6=1 if there is an error in the slave's last setting message x7=1 if the slave is already set up by another master module
1	x0: prm_required x1: diag_data_rdy x2: is_slave_diag x3: wdt_active x4: freeze_mode x5: sync_mode x6 (non utilisé) x7: inactive	x0=1 if the slave should be configured and set up again x1=1 if the slave generated a diagnostic to be processed by the master x2=0/1 if the diagnostic was created by the master / by the slave x3=1 if the slave's watchdog is active x4=1 if the selected slave inputs are frozen x5=1 if the selected slave outputs are frozen x7=1 if the slave is inactive (excluded from the processing)
2	x0..x6 (unused) x7: diag_overflow	x7=1 if the number of diagnostic bytes exceeds the size of the reception words
3	master_address	Address of the master module that sets up the slave
4-5	PNO_identifier	Slave's identification code
6-244	specific_diag (unused)	Optional specific diagnostic data (none for the LUF7 gateway)

Appendix E: Profibus-DP Data and Diagnostics

Gateway Configuration Data

These data are transmitted to the Profibus-DP master upon gateway initialization exchanges. These exchanges enable the Profibus-DP master to set up, configure, and diagnose each of the slaves. The TSX PBY 100 coupler conducts these setup exchanges, but they are not documented in its *Implementation Manual*. Please refer to the general documentation about the Profibus-DP standard if you want further information about initialization exchanges.

If you want to review the configuration data that have been exchanged during Profibus-DP slave setup, you may use the SEND_REQ function in an application developed using PL7 PRO. You must then use the 0x0031 command code and specifically request the reading of the configuration data for the slave concerned (see *Implementation Manual* of the TSX PBY 100 coupler).

The table below describes the structure and content of the response issued by the TSX PBY 100 coupler to a read command of the LUF7 gateway configuration data:

Bytes	Name	Description
0-1	Total length	Total length of the configuration information, in bytes
2	Number of %IW	Total size of the input data in the %IW area
3	Number of %QW	Total size of the output data in the %QW area
4-5	%IW offset	Offset of the input data blocks in the %IW area
6-7	%QW offset	Offset of the output data blocks in the %QW area
8	Station Status	Configuration of the slave's services (see Profibus-DP standard)
9	Watchdog Factor 1	Slave timeout (see Profibus-DP standard):
10	Watchdog Factor 2	$Timeout = (Watchdog\ Factor\ 1) \times (Watchdog\ Factor\ 2) \times 10\ ms$
11	Min TSDR	Minimum slave TSDR (see Profibus-DP standard)
12-13	PNO_Identifier	Slave identification number (see Profibus-DP standard)
14	Group Flags	Identifiers that characterize the slave's group (see Profibus-DP standard)
15	Address ID	Slave's address on the bus
16	Modular slave	Value = 0x00 / 0x01 if the slave is a compact / modular equipment device
17	Active slave	Value = 0x00 / 0x01 if the slave is inactive/active on the network
18-19	Parameters size	Size (a bytes) of the parameters data block for that slave
20-21	Configuration data size	Size (b bytes) of the configuration data block for that slave
22-23	Size of the data used	Size (c bytes) of the data block used for that slave
24- (23+a)	Parameters	Parameters data block for that slave
(24+a)- (23+a+b)	Configuration data	Configuration data block for that slave
(24+a+b)- (23+a+b+c)	Data used	Data block used for that slave

Appendix E: Profibus-DP Data and Diagnostics

For the LUF7 gateway default configuration, the following response is received from the TSX PBY 100 coupler:

Bytes	Name	Value	Bytes	Name	Value
0-1	Total length	0x0019	14	Group Flags	0x00
2	Number of %IW	0x10	15	Address ID (1)	0x02
3	Number of %QW	0x10	16	Modular slave	0x01
4-5	%IW offset	0x0000	17	Active slave	0x01
6-7	%QW offset	0x0000	18-19	Settings size	0x0000
8	Station Status	0x38	20-21	Configuration data size	0x0001
9	Watchdog Factor 1	0x14	22-23	Size of the data used	0x0000
10	Watchdog Factor 2	0x01	—	Settings	—
11	Min TSDR	0x0B	24	Configuration data	0x7F
12-13	PNO_Identifier	0x071F	—	Data used	—

- (1) This value corresponds to the gateway address on the Profibus-DP network, and its value depends on the position of the two coding wheels described in chapter 2.7.1.

NOTE: Depending on the network configuration and status, the resulting data are likely not to be strictly identical to the ones presented above.

General Gateway Information

Another command, also sent to a Profibus-DP master, makes it possible to obtain less detailed information than a slave's configuration data, and the values of statistic counters related to the exchanges between the queried master and the slave.

If you wish to review the general information regarding a Profibus-DP slave, you may use the SEND_REQ function in an application developed using PL7 PRO. Then, you must use the 0x0031 command code and specifically request that the information for the slave concerned be read (see *Implementation Manual* of the TSX PBY 100 coupler).

The table below describes the structure and content of the response issued by the TSX PBY 100 coupler to a read command of the LUF7 gateway general information:

Bytes	Name	Description
0	Configured	0x01 if the slave was configured in accordance with Profibus
1	Operating	0x01 if the slave has been set up and operates properly
2-3	Number of %IW	Total size (words) of the input data in the %IW area
4-5	Number of %QW	Total size (words) of the output data in the %QW area
6	Input data size	Total size (bytes) of the input data on Profibus
7	Output data size	Total size (bytes) of the output data on Profibus
8	Diagnostic data size	Total size (bytes) of the first diagnostic received
9	Compact diagnostic	Compact diagnostic data for that slave
10	Diagnostic counter	Total number of diagnostic messages received from that slave
11	Exchange counter	Number of exchanges between the master and this defective slave
12	Unavailability counter	Number of times this slave is present but unavailable
13	Invalid response counter	Number of invalid responses for this slave

Appendix E: Profibus-DP Data and Diagnostics

For the LUFP7 gateway default configuration, the following response is received from the TSX PBY 100 coupler:

Bytes	Name	Value
0	Configured	0x01
1	Operating	0x01
2-3	Number of %IW	0x0010
4-5	Number of %QW	0x0010
6	Input data size	0x20
7	Output data size	0x20

Bytes	Name	Value
8	Diagnostic data size	0x06
9	Compact diagnostic	0x00
10	Diagnostic counter (1)	0x0A
11	Exchange counter (1)	0x02
12	Unavailability counter (1)	0x03
13	Invalid response counter (1)	0x02

- (1) The values of all four counters vary while the coupler and gateway are operating. These are modulo 256 counters, i.e. their values loop back from 255 to 0.

Appendix F: Modbus Commands

Only the Modbus commands shown in the right-hand table are supported by the gateway. The structure of the query and response frames for each of these commands is then described in the following chapters.

Function code		Broadcast (1)	Modbus command
3	0x03	—	Read Holding Registers
6	0x06	Yes	Preset Single Register
16	0x10	Yes	Preset Multiple Registers

- (1) The content of this column shows whether the command can be added (“Yes”) or not (“—”) to the list of a broadcaster node’s commands, known as “Broadcaster” in ABC-LUFP Config Tool.

In the following chapters, each byte of the query and response frames of a Modbus command are described, one after another, with the exception of the fields shown opposite. These are always present in the queries and responses of all Modbus commands.

The “Slave Address” and “Function” fields are the first two bytes of these frames. The two bytes of the “Checksum” are their last two bytes.

Slave Address	- Value cannot be changed (Modbus address: 1 to 247. Addresses 65, 126, and 127 prohibited)
Function	- Value cannot be changed (code of the Modbus command)
... Other fields Specific features of Modbus commands ...
Checksum (Lo)	- Type of error check
Checksum (Hi)	- Number of the 1st byte checked

The descriptions of the Modbus frames which appear in the following chapters are mainly intended to help you to configure the gateway’s Modbus exchanges using ABC-LUFP Config Tool. Please see the documentation of each Modbus slave to check for any restriction regarding these frames (number of registers which can be read or written in a single Modbus command, for example).

It is a better idea to get hold of a standard Modbus document, such as the guide entitled *Modicon Modbus Protocol Reference Guide* (ref.: PI-MBUS-300 Rev. J), so that you can see the correspondence between the elements displayed in ABC-LUFP Config Tool and the content of the corresponding Modbus frames. Here is an example of a correspondence for a full frame (including the start and end of frame fields shown above), based on the “Read Holding Registers” Command (0x03):

	Elements under ABC-LUFP Config Tool	Modbus frame fields	Size
Modbus query	Slave Address	Slave no.	1 byte
	Function Code	Function no.	1 byte
	Starting register address	No. of the 1st word (MSB / LSB)	2 bytes
	Number of registers	Number of words (MSB / LSB)	2 bytes
	Checksum	CRC16 (LSB / MSB)	2 bytes
Modbus response	Slave Address	Slave no.	1 byte
	Function Code	Function no.	1 byte
	Byte count	Number of bytes read	1 byte
	Data	Value of 1st word (MSB / LSB)	2 bytes
	
		Value of last word (MSB / LSB)	2 bytes
Checksum	CRC16 (LSB / MSB)	2 bytes	

Appendix F: Modbus Commands

Chapter 6.12, also shows a few examples of correspondences between the elements displayed in ABC-LUFP Config Tool and the corresponding Modbus frame fields.

See also: Chapter 6.12.2, and chapter 6.12.3, if the implementation of one of these commands would be incompatible with its implementation in the gateway, for example. You then have to create a special Modbus command to compensate for this incompatibility.

NOTE: Here, the notions of “input” and “output” (and assimilated) are irrelevant, as all Modbus commands have access to all of a Modbus slave’s memory. However, these names are retained in order to comply with the terms used in the standard Modbus documentation.

“Read Holding Registers” Command (0x03)

Frame	Field	Value or properties
Query	Starting Address (MSB)	- Address of the 1st output / internal register
	Starting Address (LSB)	
	Number of points (PF)	- Number of output / internal registers
	Number of points (Pf)	
Response	Byte count	- Number of data bytes = Number of output / internal registers × 2
	Data (first register / MSB)	- Byte swap = “No swapping” (or “Swap 2 bytes”)
	Data (premier registre / Pf)	
	- Data length = Value of the “Byte count” field
	Data (demier registre / PF)	- Data location = Address in the gateway’s input memory
Data (demier registre / Pf)		

“Preset Single Register” Command (0x06)

Frame	Field	Value or properties
Query	Register (MSB)	- Address of the output / internal register
	Register (LSB)	
	Preset data (MSB)	- Byte swap = “No swapping” (or “Swap 2 bytes”)
	Preset data (LSB)	- Data length = 0x0002 - Data location = Address in the gateway’s output memory
Response	Register (MSB)	- Byte swap = “No swapping” (or “Swap 2 bytes”)
	Register (LSB)	- Data length = 0x0002
	Preset data (MSB)	- Data location = Address in the gateway’s input memory
	Preset data (LSB)	NOTE: These data are an echo to the query. So in most cases there is no need to feed them back to the Profibus-DP master.

NOTE: Instead of creating a link between the echo of the response to the “**Preset Single Register” Command (0x06)** and the memory area dedicated to the Profibus-DP inputs (0x0002-0x00F3), you’d better link it with the address 0x0400.

Appendix F: Modbus Commands

“Preset Multiple Registers” Command (0x10)

Frame	Field	Value or properties
Query	Starting Address (MSB)	- Address of the 1st output / internal register
	Starting Address (LSB)	
	Number of Registers (MSB)	- Number of output / internal registers
	Number of Registers (LSB)	
	Byte Count	- Number of data bytes = number of output / internal registers × 2
	Data (first register / MSB)	- Byte swap = “No swapping” (or “Swap 2 bytes”)
	Data (first register / LSB)	
	- Data length = Value of the “Byte count” field
	Data (last register / MSB)	- Data location = Address in the gateway’s output memory
Data (last register / LSB)		
Response	Starting Address (MSB)	- Address of the 1st output / internal register
	Starting Address (LSB)	
	Number of Registers (MSB)	- Number of output / internal registers
	Number of Registers (LSB)	

Modbus Protocol Exception Responses

When it cannot process a command dictated by a Modbus query, a slave sends an exception response instead of the normal response to the query.

WARNING

UNATTENDED OPERATION OF THE SYSTEM

With standard Modbus commands, the LUFFP7 gateway considers that all the exception responses it receives from Modbus slaves are incorrect responses. As a result, it will carry out the re-transmissions configured for the queries involved.

If you want the software application for your Profibus-DP master to be able to specifically manage exception responses, you can replace the Modbus command, in ABC-LUFFP Config Tool, with a personalized command (see chapter 6.12.3.2). This then allows you to feed back the “Slave Address” and “Function” fields to the Profibus-DP master.

Failure to follow this instruction can result in death, serious injury, or equipment damage.

The structure of an exception response is independent of the Modbus command associated with the “Function” field of the query involved. The whole frame of an exception response is shown below:

Slave Address	Modbus address (1 to 247; addresses 65, 126 and 127 prohibited): The value of this field is identical to that of the “Slave Address” field of the query involved.
Function	Command code, with exception indicator: The value of this field is set to 0x80 + the value of the “Function” field of the query involved.
Exception Code	Code indicating the nature of the error which has caused the exception response (see table on next page).
Checksum (Lo)	Error check
Checksum (Hi)	

Appendix F: Modbus Commands

Code	Name of the exception	Description of the exception
0x01	ILLEGAL FUNCTION	The query's "Function" command code is not implemented in the Modbus slave software, or it is unable to process it for the moment.
0x02	ILLEGAL DATA ADDRESS	The combination of the query's "Starting Address" and "No. of Registers" fields (or assimilated fields) gives access to one or more addresses which are not accessible on the Modbus slave.
0x03	ILLEGAL DATA VALUE	The value of one of the Modbus query's fields is outside the authorized limits. This error does not affect the content of the "Data" (or assimilated) fields, as this error only takes account of the fields used for managing the Modbus protocol.
0x04	SLAVE DEVICE FAILURE	An unrecoverable failure has occurred when processin the command.
0x05 (1)	ACKNOWLEDGE	The Modbus slave informs the gateway that it has accepted the command (acknowledgement), but that it will take too long to process it and it cannot afford to wait for the completion of this process before sending a response. The gateway should transmit subsequent queries in order to determine whether the command has finished or not.
0x06 (1)	SLAVE DEVICE BUSY	The Modbus slave informs the gateway that it is already in the process of running a command and therefore it cannot run the one transmitted to it. So the gateway should re-transmit the query subsequently.
0x07 (1)	NEGATIVE ACKNOWLEDGE	The Modbus slave informs the gateway that it cannot process the requested command. This exception only affects commands 13 and 14 (0x0D and 0x0E). These functions are not part of the standard Modbus commands and are not described in this document.
0x08 (1)	MEMORY PARITY ERROR	The Modbus slave informs the gateway that it has detected a parity error on the access to its own memory. This exception only affects standard commands 20 and 21 (0x14 and 0x15) which are not supported by the gateway.

(1) Please see the standard Modbus documentation for further information about these various scenarios.

Appendix G: Concept and Quantum PLC

The default data type of Concept with a Quantum PLC is "BOOL".

As shown in the first drawing hereafter, "BOOL" should not be used for the data storage of the LUF7. The bytes (MSB/LSB) and bits are twisted with data type "BOOL".

The data type for the LUF7 gateway at Concept should be changed to "INT16" or "UINT16". In this case the data storage of the gateway and the PLC is identical.

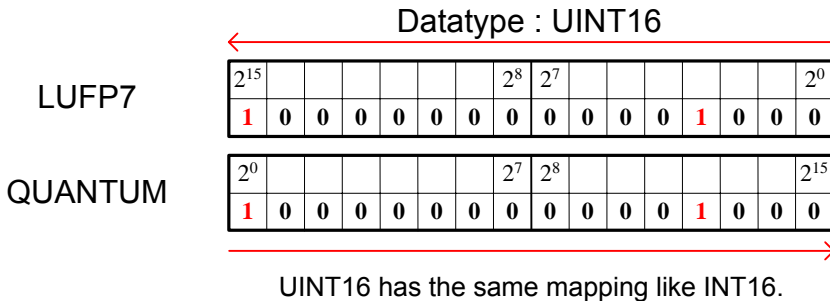
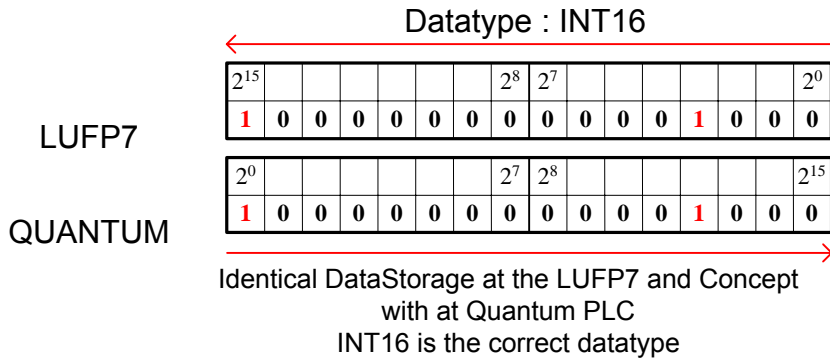
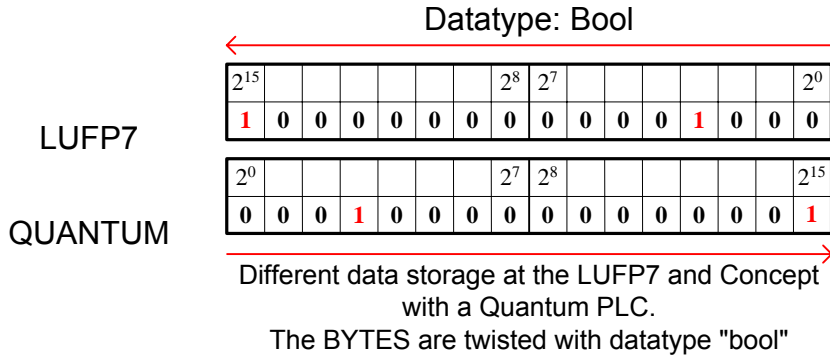

Index

- 2**
 - 2-way TSXSCA62 subscriber connector, 19
- A**
 - Address, 23
 - Architecture, 9, 28
- C**
 - Cable
 - type A, 20, 22
 - Communications
 - aperiodic, 44
 - periodic, 44
 - Cycle time, 29
- D**
 - Data exchanged, 11
 - Diagnostic LEDs, 12
 - DIN Rail, 13
- E**
 - End of line connector, 22
- G**
 - Gateway's address, 23
 - GSD file, 36
- L**
 - LEDs, 25
 - Line connector, 22
 - Line termination, 21
 - LU9GC03 hub, 19
- M**
 - Modbus cable, 19
- P**
 - PL7 PRO, 34, 39, 40, 42, 68, 77, 121
 - Product Related Warning, 5
 - Profibus-DP master, 34
 - Protective Earth, 13
- R**
 - Related documents, 5
 - RJ45 connector, 12
- S**
 - SyCon, 28, 34, 35, 37, 73, 76, 116, 121
- T**
 - SCA junction boxes, 17
 - Topology
 - bus, 16
 - TSXCA50 SCA junction box, 19
 - Type A cable, 20
- V**
 - VW3 A8 306 RC double termination, 19
 - VW3 A8 306 TF3 T-junction box, 19

Glossary

0x****	Value expressed in hexadecimal, which is equivalent to the H****, ****h and 16#**** notations, sometimes used in other documents. NOTE: The ABC-LUFP Config Tool software uses the 0x**** notation. e.g. 0x0100 = 16#0100 = 256.
2#**** ****	Value expressed in binary. The number of ‘.’ digits depends on the size of the item of data represented. Each nibble (group of 4 bits) is separated from the other nibbles by a space. Examples: byte 2#0010 0111 = 39, word 2#0110 1001 1101 0001 = 0x69D1 = 27089.
ABC-LUFP Config Tool	Name of the PC software used to configure and monitor the LUFP7 Profibus-DP/Modbus Gateway.
ASIC	Integrated circuits specific to a given user and application, covering two major families: pre-characterised processes and pre-distributed networks.
ATS	Abbreviation of “Altistart” (soft start- soft stop unit).
ATV	Abbreviation of “Altivar” (drive).
CRC	Cyclical Redundancy Check.
LED	Light-Emitting Diode.
DP	Decentralised Periphery (remote I/O). Profibus version or <i>protocol</i> meant for quick communication with remote I/O. This is the only Profibus protocol supported by the LUFP7 gateway.
DPM1	Class 1 DP master: the central automatic control of a Profibus-DP network. It resets and controls I/O transfers and slave diagnostics on the network. One can have several DPM1 stations on a given Profibus-DP network, each one steering its own slaves.
DPM2	Class 2 DP master: The programming, configuration, and diagnostic device of a Profibus-DP network.
Fieldbus	A term referring to the upstream Profibus-DP network in ABC-LUFP Config Tool.
FMS	Profibus-FMS messaging system that defines the objects and application services applicable to these objects. By extension, the Profibus version or <i>protocol</i> dedicated to complex and advanced communication tasks at the cell level. This protocol is not supported by the LUFP7 gateway.
GSD	Electronic equipment database, also called GSD <i>file</i> . This term designates the format of the files (“.gsd” extension) that are used by a Profibus master configuration and adjustment tool to configure their exchanges according to that same protocol.
Handshake	An old term referring to the two registers used for initialising and carrying out diagnostics of the LUFP7 gateway. This term has been replaced by the expression “Control/Status Byte”.
LRC	Longitudinal Redundancy Check.
LSB	Least significant byte in a 16-bit word.

Glossary

Glossary

MSB	Most significant byte in a 16-bit word.
Node	A term referring to the connection point of a Modbus slave under ABC-LUFP Config Tool.
PA	Profibus version or protocol dedicated to process automation. This protocol is not supported by the LUFP7 gateway.
PDP	Profibus-DP (see “DP” above).
PI	Profibus International. This term designates the international organization for users of the Profibus protocol. It is responsible for federating Profibus skills centres, scattered throughout the 20 largest industrial countries. The list of user groups of the Profibus protocol is available on the Profibus web site, at http://www.profibus.com/ . To get general-purpose support on Profibus, please email to PI, at: Profibus_international@compuserve.com .
PNO	This term designates the national and local associations of Profibus protocol users.
PPO	Parameter Process data Object. This term designates the type and size of the data exchanged between a Profibus master and slave. In the case of the LUFP7 gateway, PPOs are not used to configure its exchanges on the Profibus network.
Profibus	PROcess Field BUS.
PSU	Power supply.
Sub-Network	A term referring to the downstream Modbus network under ABC-LUFP Config Tool.
TSDI	Initiating station request time.
TSDR	Answering station response time.
XML	EXtensible Markup Language. The language used by ABC-LUFP Config Tool to import/export the configuration of a Modbus slave.

