

LISTEN.  
THINK.  
SOLVE.<sup>SM</sup>

# PowerFlex<sup>®</sup>

DSI<sup>™</sup> COMMUNICATION ADAPTERS



**BACnet<sup>®</sup> MS/TP ADAPTER (22-COMM-B)**

**ControlNet<sup>™</sup> COAX ADAPTER (22-COMM-C)**

**DeviceNet<sup>™</sup> ADAPTER (22-COMM-D)**

**EtherNet/IP<sup>™</sup> ADAPTER (22-COMM-E)**

**LonWorks<sup>®</sup> ADAPTER (22-COMM-L)**

**PROFIBUS DP<sup>™</sup> ADAPTER (22-COMM-P)**

**RS-232 DF1<sup>™</sup> MODULE(22-SCM-232)**

**COMPACT I/O<sup>™</sup> MODULE (1769-SM2)**

**DSI EXTERNAL COMMUNICATIONS KIT**

**DSI WIRELESS INTERFACE MODULE**

**1203-USB CONVERTER (1203-USB)**



**PowerFlex<sup>®</sup>**  
Communications



# PRODUCT PROFILE

## 22-COMM-B BACnet® MS/TP ADAPTER

The PowerFlex® 22-COMM-B adapter provides an internal BACnet MS/TP connection to PowerFlex 40 and 400 drives. It can also be installed in a DSI External Communications Kit for use with PowerFlex 4 drives. The adapter provides a means to control, configure, and collect data over a BACnet MS/TP network.

### PRODUCT HIGHLIGHTS

**Installation** – The adapter mounts internal to PowerFlex 40 and 400 drives to save valuable panel space, and is field installable. If an external connection is needed or when using a PowerFlex 4 drive, the adapter can also be installed in a DSI External Communications Kit (22-XCOMM-DC-BASE).

**Configuration Switches** – The adapter has configuration switches for setting the MAC address (addressable up to node 127), and enabling/disabling the termination and bias resistors.

**Supported Data Rates** – The adapter can “autoband” out-of-the-box or be set to one of four selectable baud rates (9600, 19200, 38400 or 76800 bps), and can be configured using a parameter.

**Multiple Configuration Tool Options** – A number of configuration tools can be used to configure the adapter and the connected drive. These tools include the PowerFlex DSI HIM, or drive-configuration software such as DriveExplorer™ or DriveExecutive™.

**DSI Routing** – Allows DriveExplorer to connect to a PowerFlex drive using a 22-SCM-232 or 1203-USB converter and then route over BACnet MS/TP to access other Allen-Bradley® drives. This eliminates the need for a separate network connection and interface.

**BACnet Objects** – Unlike other PowerFlex drive communication adapters, BACnet MS/TP adapters use network objects to view logic status, speed feedback and monitor parameter values, and to send logic control, speed reference and change parameter values. The following objects are supported by the adapter:

- Analog Input (AI)
- Analog Output (AO)
- Analog Value (AV)
- Binary Input (BI)
- Binary Output (BO)
- Binary Value (BV)

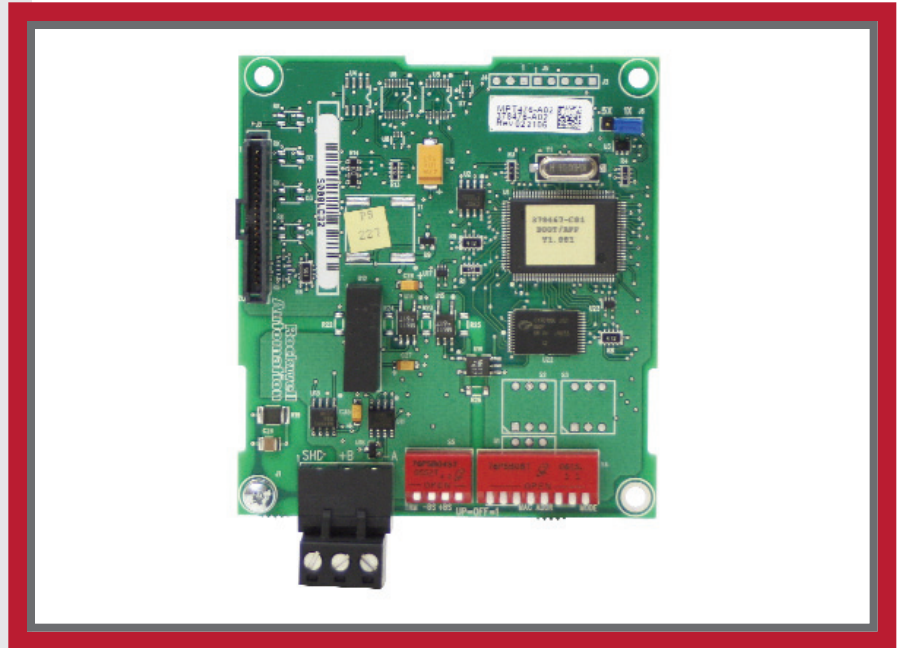

**User Configurable Fault Responses** – Selects the action that the adapter and drive will take for the following two conditions:

- Idle Fault Action – the scanner is idle (controller in program mode)
- Comm Fault Action – network communications have become disrupted

Available actions include:

- Fault – the drive is faulted and stopped
- Stop – the drive is stopped using the current deceleration rate and is not faulted
- Zero Data – the adapter zeros the I/O data transmitted to the drive
- Hold Last – the adapter continues sending the I/O data prior to the fault and the drive continues in its present state
- Send Fault Configuration – the user specifies the Logic Command, Reference, and Datalink data that is sent to the drive, allowing complete flexibility in configuring a fault action

**Diagnostics** – Built-in diagnostics allow drive-side troubleshooting of the network connection using a PowerFlex DSI HIM, DriveExplorer or DriveExecutive. View actual Logic Command/Speed Reference and Logic Status/Speed Feedback data being transmitted to and from the controller.

**Flash Upgradeable** – The adapter can be flash updated in the field using DriveExplorer, DriveExecutive or ControlFLASH to take advantage of new firmware features as they become available.



# PARAMETERS

No.	Name	Description
01	Reset Module	Resets the adapter or sets the adapter parameters to factory default.
02	Comm Loss Action	Sets the action that the adapter and drive will take if the adapter detects a network failure.
03	Comm Loss Time	Sets the communication loss timeout period (in seconds).
04	Flt Cfg Logic	Sets the data that is sent to the drive if Parameter 02 - (Comm Loss Action) is set to "Send Flt Cfg" and the adapter times out.
05	Flt Cfg Ref	Sets the baud rate (kilobits per second) at which the adapter communicates.
06	Baud Rate Cfg	Displays the baud rate (kilobits per second) actually used by the adapter.
07	Baud Rate Act	Displays the actual address selected by the MAC address switches SW1 – SW7 on the adapter.
08	MAC Address	Sets the maximum MAC address for any device in the BACnet MS/TP token ring.
09	Max Master	Sets the maximum number of messages that the adapter can transmit while it owns the token.
10	Max Info Frames	Sets the high-priority portion of the device instance number used by the adapter.
11	Device Inst Hi	Sets the low-priority portion of the device instance number used by the adapter.
12	Device Inst Lo	

# SPECIFICATIONS

Communications	Network	Protocol	BACnet MS/TP
	Drive	Data Rates	9600, 19200, 38400 or 76800 bps
Electrical	Consumption	Protocol	DSI
		Data Rate	19.2 Kbps
Regulatory		Drive (DSI)	275 mA at 5 VDC
		Network	None
		BACnet	BTL (BACnet Testing Laboratories) approval pending
		UL	UL508C
		cUL	CAN/CSA C22.2 No. 14-M91
		CE	EN50178 and EN61800-3
		CTick	EN61800-3

## MAC ADDRESS SWITCHES

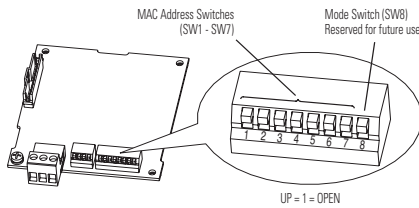

Switches	Description	Default
SW1	Least Significant Bit (LSB) of MAC Address	0
SW2	Bit 1 of MAC Address	0
SW3	Bit 2 of MAC Address	0
SW4	Bit 3 of MAC Address	0
SW5	Bit 4 of MAC Address	0
SW6	Bit 4 of MAC Address	0
SW7	Most Significant Bit (MSB) of MAC Address	0
SW8	Mode (reserved for future use)	—

Node 0

## WIRING CONNECTIONS

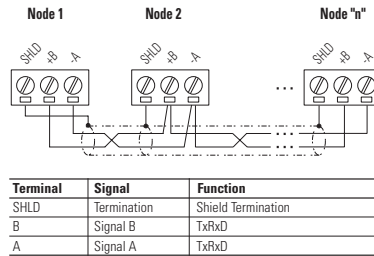

## TERMINATION/BIAS SWITCHES

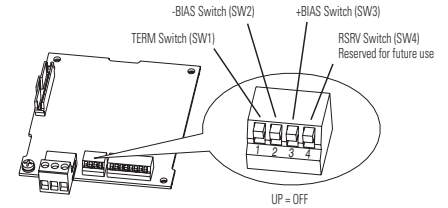

Switches	Description	Default
SW1	Turns on/off the termination resistor	Up (Off)
SW2	Turns on/off the -bias resistor	Up (Off)
SW3	Turns on/off the +bias resistor	Up (Off)
SW4	Reserved (not used)	—

## NETWORK ROUTING EXAMPLE

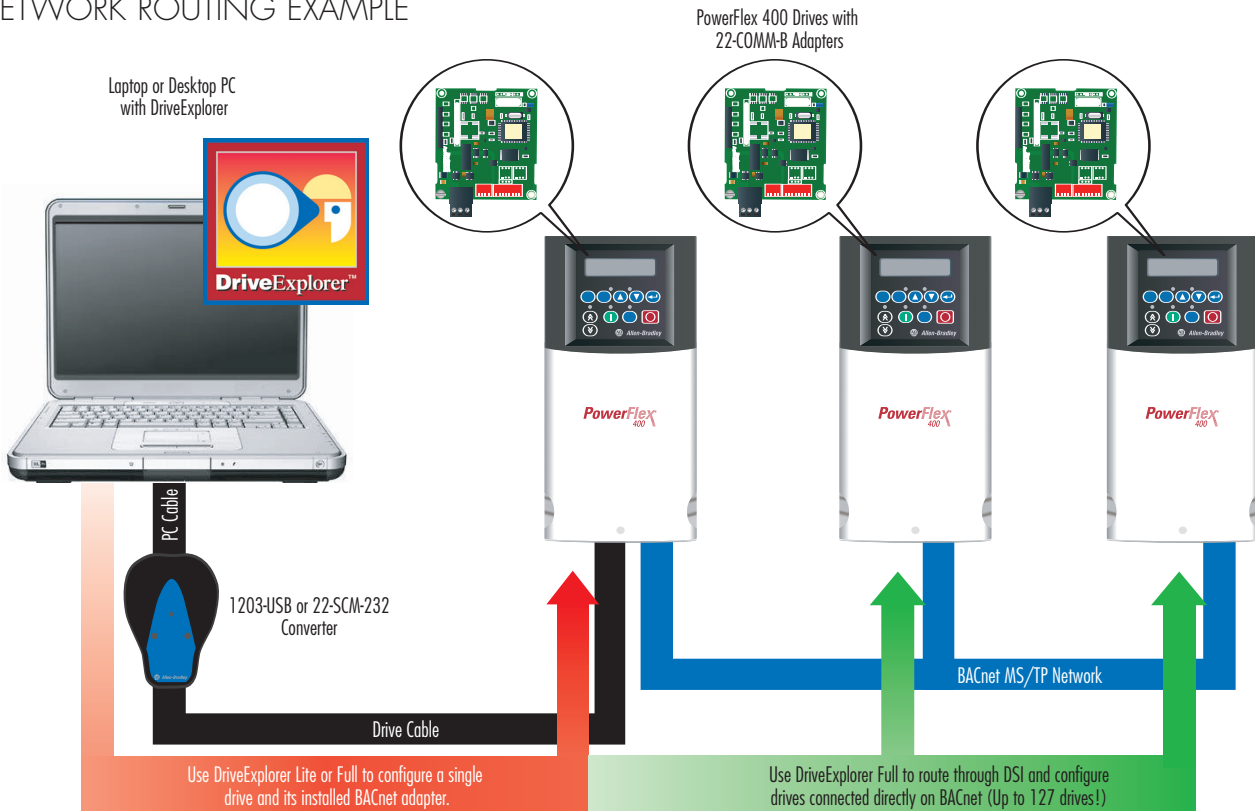

# PRODUCT PROFILE

## 22-COMM-C ControlNet™ ADAPTER

The PowerFlex® DSI ControlNet adapter provides redundant coaxial ControlNet connections for PowerFlex 40 or PowerFlex 400 drives. The adapter provides a means to control, configure, and collect data over a ControlNet network. It can also be used with other Allen-Bradley products that support a DSI adapter, such as the DSI External Communications Kit (22-XCOMM-DC-BASE), which enables PowerFlex 4 drives to connect to a ControlNet network.

### PRODUCT HIGHLIGHTS

**Internal Mount** – The adapter mounts internal to the drive to save panel space and is field installable. PowerFlex 40 B frame drives require an additional front cover 22B-CCB, PowerFlex 40 C frame drives require 22B-CCC, and PowerFlex 400 C frame drives require 22C-CCC.

**Configuration** – The adapter has rotary switches for setting the node address and a jumper for configuring Single or Multi-Drive operating modes.

**Multiple Configuration Tool Options** – A number of configuration tools can be used to configure the adapter and the connected drive. These tools include the PowerFlex DSI HIM or drive-configuration software such as DriveExplorer™ or DriveExecutive™.

#### Single/Multi-Drive Operation –

The adapter can be used in two modes:

- Single - 1 network node consists of 1 drive.
- Multi-Drive - 1 network node can contain up to 5 drives. In this cost-saving configuration, the 22-COMM-C adapter is installed in a PowerFlex 40 or 400 drive and up to four additional PowerFlex 4, 40 or 400 drives can be connected over their built-in RS-485 ports. Each drive can be individually controlled, configured, and monitored through the single ControlNet connection. The adapter can also be installed in a DSI External Communications Kit using this operation mode to communicate with up to 5 PowerFlex 4-Class drives.

**I/O Messaging** – I/O messaging is used to transfer time-critical data, such as data that controls the drive. The following data can be sent and received by the adapter:

- Logic Status/Speed Feedback
- Logic Command/Speed Reference

**Explicit Messaging** – Explicit messaging involves non time-critical information that is typically triggered by the application (ladder program in a controller, etc.). The adapter supports:

- Reading/writing of drive parameters
- Reading/writing of adapter parameters

**PowerFlex®**  
Communications

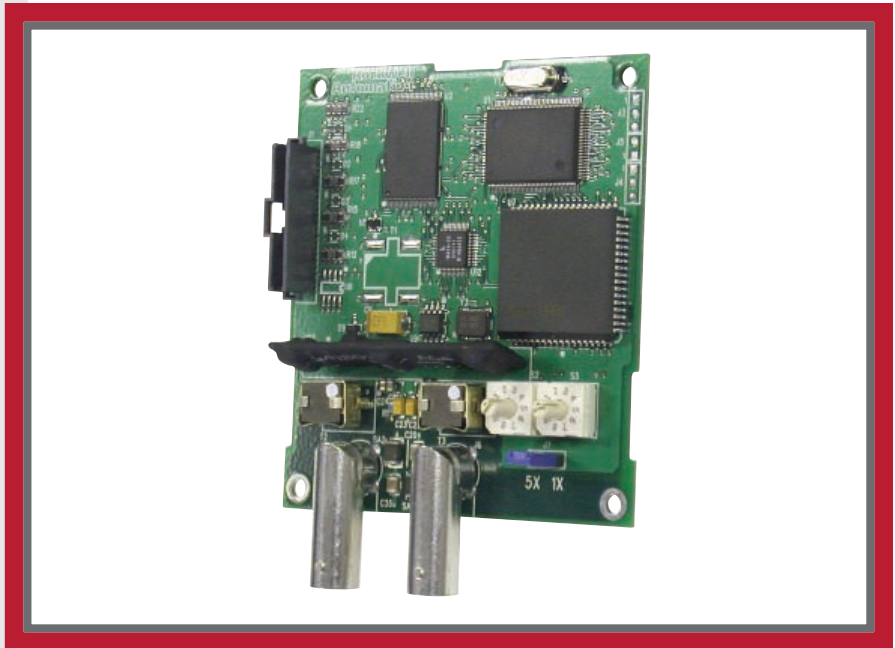

**User Configurable Fault Responses** – Selects the action that the adapter and drive will take for the following two conditions:

- Idle Fault Action - The scanner is idle (controller in program mode.)
- Comm Fault Action - Network communications have become disrupted.

Available actions include:

- Fault - The drive is faulted and stopped.
- Stop - The drive is stopped using the current deceleration rate and is not faulted.
- Zero Data - The adapter zeros the I/O data transmitted to the drive.
- Hold Last - The adapter continues sending the I/O data prior to the fault and the drive continues in its present state.
- Send Fault Configuration - The user specifies the Logic Command and Speed Reference data that is sent to the drive, allowing complete flexibility in configuring a fault action.

**Diagnostics** – Built-in diagnostics allow drive-side troubleshooting of the network connection using a PowerFlex DSI HIM, DriveExplorer or DriveExecutive. View actual Logic Status/Speed Feedback and Logic Command/Speed Reference data being transmitted to and from the controller.

**Flash Upgradeable** – The adapter can be flash updated in the field using DriveExplorer, DriveExecutive or ControlFLASH to take full advantage of new firmware features as they become available.

## PARAMETERS

No.	Name	Description
01	Mode	Displays the Single or Multi-Drive operating mode selected with the Operating Mode Jumper (J7) on the adapter.
02	CN Addr Cfg	Sets the ControlNet node address if the Node Address Switches are set to "00". (Updates Parameter 03 - [CN Addr Act] after a reset.)
03	CN Addr Act	Displays the ControlNet node address actually used by the adapter.
04	CN Rate Cfg	Sets the ControlNet data rate (megabits per second) at which the adapter communicates. (Updates Parameter 05 - [CN Rate Act] after a reset.)
05	CN Rate Act	Displays the ControlNet data rate (megabits per second) actually used by the adapter.
06	CN Active Cfg	Displays the source from which the adapter node address is taken. This will be either switches or Parameter 02 - [CN Addr Cfg] in EEPROM. It is determined by the settings of the Node Address Switches on the adapter. If the Node Address Switches = "00" on power up, then Parameter 02 - [CN Addr Cfg] is used to configure the adapter's ControlNet address.
07	Reset Module	Resets the adapter or sets parameter defaults settings.
08	Comm Flt Action	Sets the action that the adapter and drive will take if the adapter detects that network communications have been disrupted. This setting is effective only if I/O that controls the drive is transmitted through the adapter.
09	Idle Flt Action	Sets the action that the adapter and drive will take if the adapter detects that the controller is in program mode. This setting is effective only if I/O that controls the drive is transmitted through the adapter.
10	Flt Cfg Logic	Sets the Logic Command or Speed Reference data that is sent to the drive if any of the following is true: - Parameter 08 - [Comm Flt Action] is set to "Send Flt Cfg" and communications are disrupted. - Parameter 09 - [Idle Flt Action] is set to "Send Flt Cfg" and the controller is in program mode.
11	Flt Cfg Ref	
12	DSI I/O Cfg	Sets the configuration of the drives that are active in the Multi-Drive mode, and identifies the DSI connections that would be attempted on a reset or power cycle.
13	DSI I/O Act	Displays the drives that are active in the Multi-Drive mode.
14	Drv 0 Addr	Sets the corresponding node addresses of the daisy-chained drives when the adapter Operating Mode Jumper (J7) is set for Multi-Drive operation.
15	Drv 1 Addr	
16	Drv 2 Addr	
17	Drv 3 Addr	
18	Drv 4 Addr	
19	Ref Adjust	Sets the percent scale factor for the Speed Reference from the network.

## SPECIFICATIONS

Communications	Network	Protocol	ControlNet
		Data Rate	5 Mbps
	Drive	Protocol	DSI
		Data Rate	19.2 Kbps
Electrical	Consumption	Drive	275 mA at 5 VDC
		Network	N/A
Regulatory Compliance		UL	UL508C
		cUL	CAN/CSA C22.2 No. 14-M91
		CE	EN50178 and EN61800-3
		CTick	AS/NZS 2064, Group 1, Class A

## EXAMPLE I/O IMAGE - SINGLE MODE

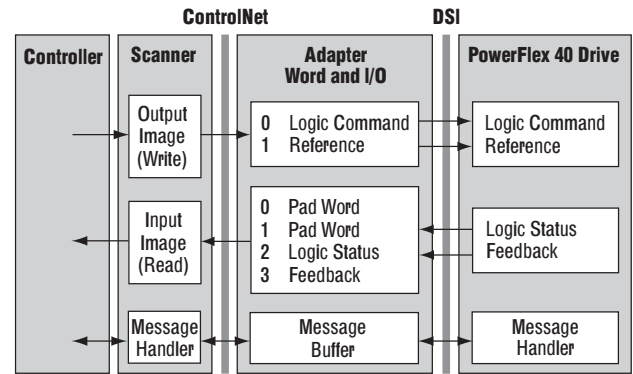

## EXAMPLE I/O IMAGE - MULTI-DRIVE MODE

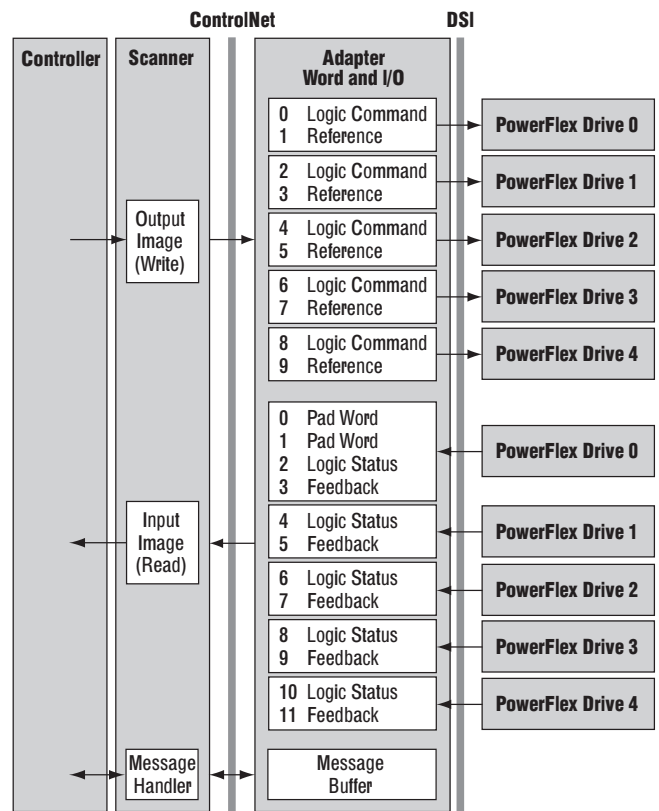

# PRODUCT PROFILE

## 22-COMM-D DeviceNet™ ADAPTER

The PowerFlex® 22-COMM-D adapter provides a DeviceNet network connection for PowerFlex 40 AC drives and other DSI-based host devices with an internal communications slot. The adapter provides a means to control, configure and collect data over a DeviceNet network.

### PRODUCT HIGHLIGHTS

**Internal Mount** – The adapter mounts internal to the drive to save panel space, and is field installable. PowerFlex 40 drives require an additional front cover (22B-CC\*).

**Configuration Switches** – The adapter has DIP switches for setting the node address (0-63), data rate (125/250/500/Auto kbps), and a jumper for Single/Multi-Drive modes.

**Multiple Configuration Tool Options** – A number of configuration tools can be used to configure the adapter and the connected drive. These tools include the PowerFlex HIM, or drive-configuration software such as DriveExplorer™ or DriveExecutive™.

**Single/Multi-Drive Operation** – The adapter can be used in two modes:

- Single – 1 network node consists of 1 drive.
- Multi-Drive – 1 network node can contain up to 5 drives. In this cost-saving configuration, the 22-COMM-D is installed in a PowerFlex 40 drive and up to four additional PowerFlex 40 or 40 drives can be connected over their built-in RS-485 ports. Each drive can be individually controlled, configured, and monitored through the single DeviceNet connection.

**I/O Messaging** – I/O messaging is used to transfer time-critical data, such as data that controls the drive. The following data can be sent and received by the adapter:

- Logic Command/Reference
  - Logic Status/Feedback
- It supports Polled, Change-of-State(COS), and Cyclic I/O methods.

**Explicit Messaging** – Explicit messaging involves non time-critical information that is typically triggered by the application (ladder program in a controller, etc.). The adapter supports:

- Reading/writing of drive parameters
- Reading/writing of adapter parameters

**Automatic Device Replacement (ADR) Support** – Allows a scanner to upload and store the adapter and drive configuration settings. Upon replacing a faulty drive with a new unit, the scanner can automatically download the configuration data and set the node address.

**PowerFlex®**  
Communications

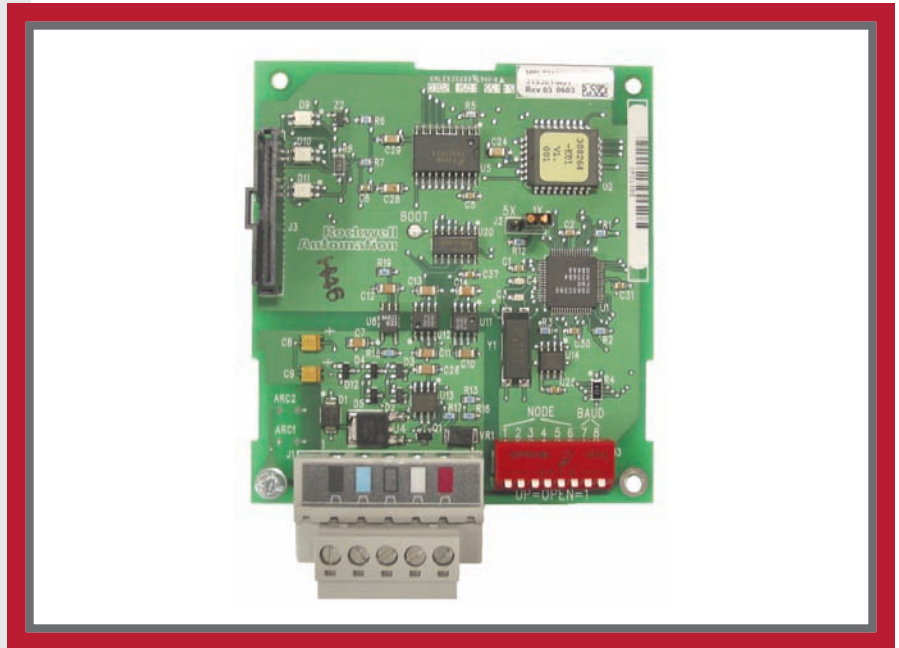

**User Configurable Fault Responses** – Selects the action that the adapter and drive will take for the following two conditions:

- Idle Fault Action – the scanner is idle (controller in program mode)
- Comm Fault Action – network communications have become disrupted

Available actions include:

- Fault – the drive is faulted and stopped
- Stop – the drive is stopped using the current deceleration rate and is not faulted
- Zero Data – the adapter zeros the I/O data transmitted to the drive
- Hold Last – the adapter continues sending the I/O data prior to the fault and the drive continues in its present state
- Send Fault Configuration – the user specifies the Logic Command and Reference data that is sent to the drive, allowing complete flexibility in configuring a fault action

**Diagnostics** – Built-in diagnostics allow drive-side troubleshooting of the network connection using a PowerFlex DSI HIM, DriveExplorer or DriveExecutive. View actual Logic Command/Reference and Logic Status/Feedback data being transmitted to and from the controller.

**Flash Upgradeable** – The adapter can be flash updated in the field using DriveExplorer, DriveExecutive or ControlFLASH to take advantage of new firmware features as they become available.

**DeviceNet™**  
CONFORMANCE TESTED

## PARAMETERS

No.	Name	Description
01	Mode	Displays the mode selected by the jumper on the adapter (Single or Multi-Drive).
02	DN Addr Cfg	Sets the DeviceNet node address after a reset or power cycle.
03	DN Addr Act	Displays the DeviceNet node address currently used by the adapter.
04	DN Rate Cfg	Sets the DeviceNet data rate after a reset or power cycle.
05	DN Rate Act	Displays the data rate actually used by the adapter.
06	Reset Module	Used to reset the adapter or set defaults.
07	Comm Flt Action	Sets the action that the adapter will take if it detects that communications have been disrupted.
08	Idle Flt Action	Sets the action that the adapter will take if it detects that the scanner is idle.
09	DN Act Cfg	Displays the source from which the adapter node address and data rate are taken.
10	Flt Cfg Logic	Sets the data that is sent to the drive if any of the following is true: <ul style="list-style-type: none"> <li>Parameter 07 - [Comm Flt Action] is set to Send Flt Cfg and communications are disrupted.</li> <li>Parameter 08 - [Idle Fault Action] is set to Send Flt Cfg and the scanner is put into Program mode.</li> </ul>
11	Flt Cfg Ref	
12	COS Status Mask	Sets the mask of the Logic Status word.
13	COS Fdbk Change	Sets the hysteresis band to determine how much the Feedback can change before it triggers a COS operation.
14	COS/Cyc Interval	Displays the amount of time that a scanner will wait to check for data in the adapter.
15	DSI I/O Config	Selects the I/O that is transferred through the adapter.
16	DSI I/O Act	Displays the I/O that the adapter is actively transmitting.
17	Drv 0 Addr	Sets the corresponding node addresses of the daisy-chained drives used in Multi-Drive mode.
18	Drv 1 Addr	
19	Drv 2 Addr	
20	Drv 3 Addr	
21	Drv 4 Addr	

## EDS FILES

The EDS files can be created on-line using RSNetWorx for DeviceNet or downloaded from:

<http://www.ab.com/drives/eds.html>

## SPECIFICATIONS

Communications	Network	Protocol	DeviceNet
		Data Rates	125, 250, 500 Kbps or Autobaud
	Drive	Protocol	DSI
Electrical	Consumption	Drive (DSI)	150 mA at 5 VDC
		Network	60 mA at 24 VDC
Regulatory Compliance		UL	UL508C
		cUL	CAN/CSA C22.2 No. 14-M91
		CE	EN50178 and EN61800-3

## EXAMPLE I/O IMAGE - SINGLE MODE

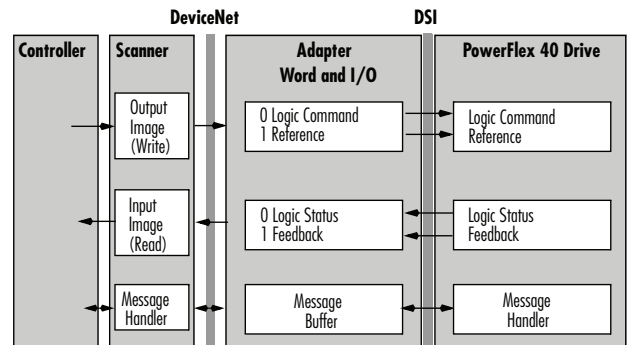

## EXAMPLE I/O IMAGE - MULTI-DRIVE MODE

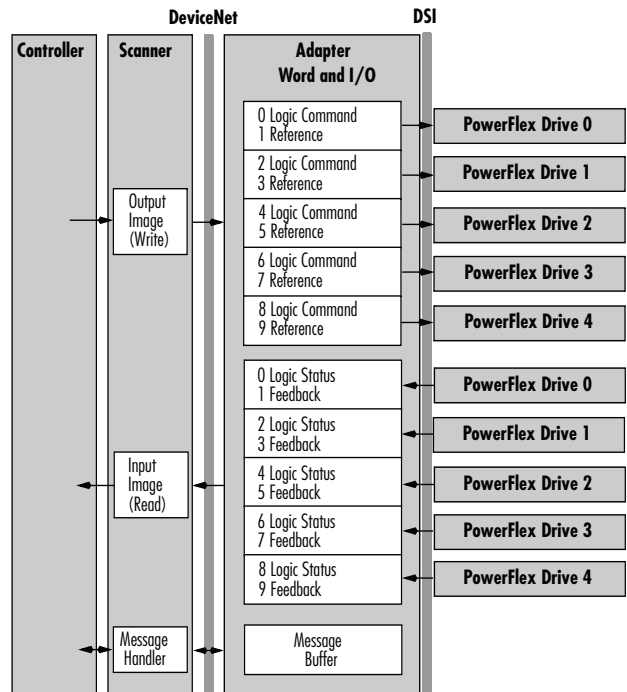



# PRODUCT PROFILE

## 22-COMM-E EtherNet/IP™ ADAPTER



The PowerFlex® 22-COMM-E adapter provides an EtherNet/IP network connection for PowerFlex 40 AC drives and other DSI-based host devices with an internal communications slot. The adapter provides a means to control, configure and collect data over an EtherNet/IP network.

### PRODUCT HIGHLIGHTS

**Internal Mount** – The adapter mounts internal to the drive to save panel space, and is field installable. PowerFlex 40 drives require an additional front cover (22B-CC\*).

**Configuration Switches** – The adapter has DIP switches for enabling /disabling the web pages and for setting Single/Multi-Drive modes.

**Multiple Configuration Tool Options** – A number of configuration tools can be used to configure the adapter and the connected drive. These tools include the PowerFlex HIM, or drive-configuration software such as DriveExplorer™ or DriveExecutive™.

**Single/Multi-Drive Operation** – The adapter can be used in two modes:

- Single – 1 network node consists of 1 drive.
- Multi-Drive – 1 network node can contain up to 5 drives. In this cost-saving configuration, the 22-COMM-E is installed in a PowerFlex 40 drive and up to four additional PowerFlex 40 drives can be connected over their built-in RS-485 ports. Each drive can be individually controlled, configured, and monitored through the single EtherNet/IP connection.

**I/O Messaging** – I/O messaging is used to transfer time-critical data, such as data that controls the drive. The following data can be sent and received by the adapter:

- Logic Command/Reference
- Logic Status/Feedback

**Explicit Messaging** – Explicit messaging involves non time-critical information that is typically triggered by the application (ladder program in a controller, etc.). The adapter supports:

- Reading/writing of drive parameters
- Reading/writing of adapter parameters

**Web Interface** – Use a web browser such as Microsoft™ Internet Explorer™ to access the drive over the Intranet or Internet.

- TCP/IP Configuration - View TCP/IP configuration data and Ethernet diagnostic information.
- Email Notification - Configure email notification if a specific fault or alarm occurs, if any fault or alarm occurs, or if the drive is reset.

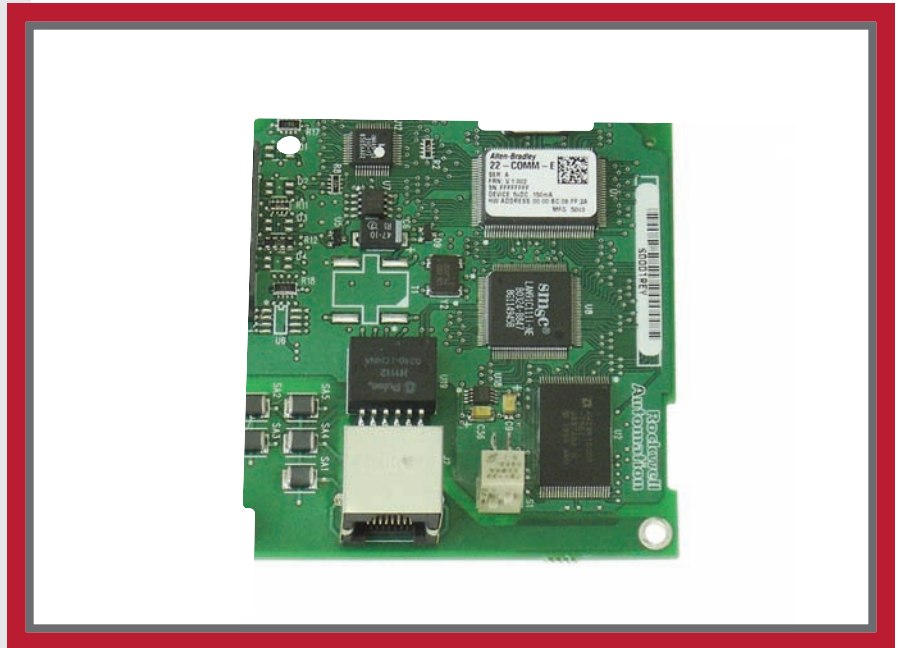

- DSI Device Browse - View every DSI device, including the drive and connected peripherals. Provides general device information, diagnostics, and event/fault queue display.
- Online User Manuals – Link to view the user manual online over the Internet.
- Software Tools Web Site – Link to the DriveExplorer and DriveExecutive Internet web sites.
- Launch Drive Software Tools – Directly launch DriveExplorer or DriveExecutive software already on your PC, and have the tool automatically connect to the drive.

**User Configurable Fault Responses** – Selects the action that the adapter and drive will take for the following two conditions:

- Idle Fault Action – the scanner is idle (controller in program mode)
- Comm Fault Action – network communications have become disrupted

Available actions include:

- Fault – the drive is faulted and stopped
- Stop – the drive is stopped using the current deceleration rate and is not faulted
- Zero Data – the adapter zeros the I/O data transmitted to the drive
- Hold Last – the adapter continues sending the I/O data prior to the fault and the drive continues in its present state
- Send Fault Configuration – the user specifies the Logic Command and Reference data that is sent to the drive, allowing complete flexibility in configuring a fault action

**Diagnostics** – Built-in diagnostics allow drive-side troubleshooting of the network connection using a PowerFlex DSI HIM, DriveExplorer or DriveExecutive. View actual Logic Command/Reference and Logic Status/Feedback data being transmitted to and from the controller.

**Flash Upgradeable** – The adapter can be flash updated in the field using DriveExplorer, DriveExecutive or ControlFLASH to take advantage of new firmware features as they become available.



## PARAMETERS

No.	Name	Description
01	Mode	Displays the mode selected by the jumper on the adapter (Single or Multi-Drive).
02	BOOTP	Sets the DeviceNet node address after a reset or power cycle.
03	IP Addr Cfg 1	Sets the respective bytes in the IP address, where the represented address is: Cfg1.Cfg2.Cfg3.Cfg4.
04	IP Addr Cfg 2	
05	IP Addr Cfg 3	
06	IP Addr Cfg 4	
07	Subnet Cfg 1	Sets the bytes of the subnet mask, where the represented mask is :Cfg1.Cfg2.Cfg3.Cfg4.
08	Subnet Cfg 2	
09	Subnet Cfg 3	
10	Subnet Cfg 4	
11	Gateway Cfg 1	Sets the bytes of the gateway address, where the represented address is: Cfg1.Cfg2.Cfg3.Cfg4.
12	Gateway Cfg 2	
13	Gateway Cfg 3	
14	Gateway Cfg 4	
15	EN Rate Cfg	Configures the network data rate at which the adapter communicates.
16	EN Rate Act	Displays the data rate actually used by the adapter.
17	Reset Module	Used to reset the adapter or set defaults.
18	Comm Flt Action	Sets the action that the adapter will take if it detects that communications have been disrupted.
19	Idle Flt Action	Sets the action that the adapter will take if it detects that the scanner is idle.
20	Flt Cfg Logic	Sets the data that is sent to the drive if any of the following is true: <ul style="list-style-type: none"> <li>Parameter 18 - [Comm Flt Action] is set to Send Flt Cfg and communications are disrupted.</li> <li>Parameter 19 - [Idle Fault Action] is set to Send Flt Cfg and the scanner is put into Program mode.</li> </ul>
21	Flt Cfg Ref	
22	DSI I/O Config	Selects the I/O that is transferred through the adapter.
23	DSI I/O Act	Displays the I/O that the adapter is actively transmitting.
24	Drv 0 Addr	Sets the corresponding node addresses of the daisy-chained drives used in Multi-Drive mode.
25	Drv 1 Addr	
26	Drv 2 Addr	
27	Drv 3 Addr	
28	Drv 4 Addr	
29	Web Enable	Displays the setting of the web pages switch on the adapter when the adapter was last reset. (Enables/Disables using web pages)
30	Web Features	Sets the access to the web interface and web configurable features.

## SPECIFICATIONS

Communications	Network	Protocol	EtherNet/IP
		Data Rates	10/100 Mbps, Full/Half Duplex
	Drive	Protocol	DSI
Electrical	Consumption	Drive (DPI)	350 mA at 5 VDC
		Network	N/A
Regulatory Compliance		UL	UL508C
		cUL	CAN/CSA C22.2 No. 14-M91
		CE	EN50178 and EN61800-3

## EXAMPLE I/O IMAGE - SINGLE MODE

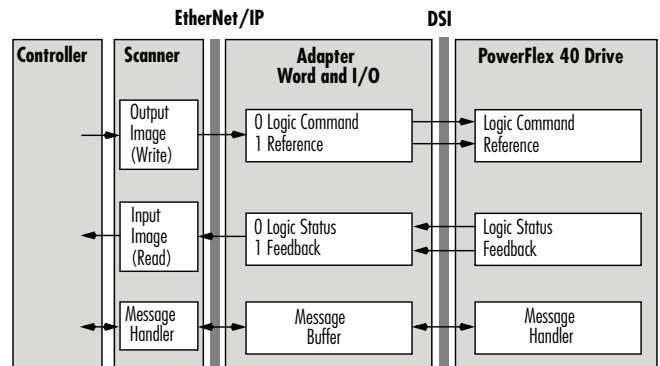

## EXAMPLE I/O IMAGE - MULTI-DRIVE MODE

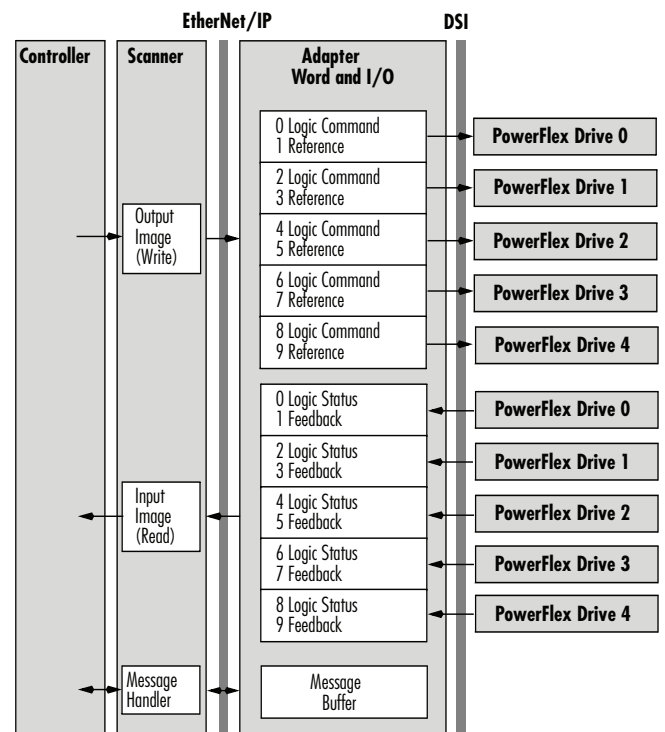

# MAIN WEB PAGE

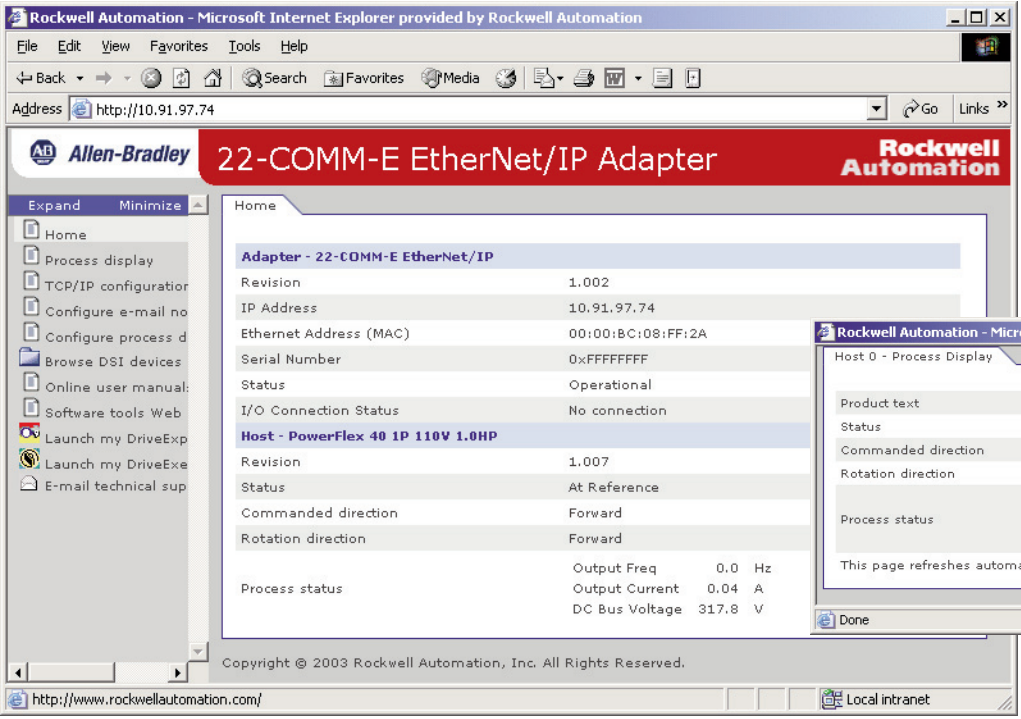

AUTO-REFRESH  
PROCESS DISPLAY

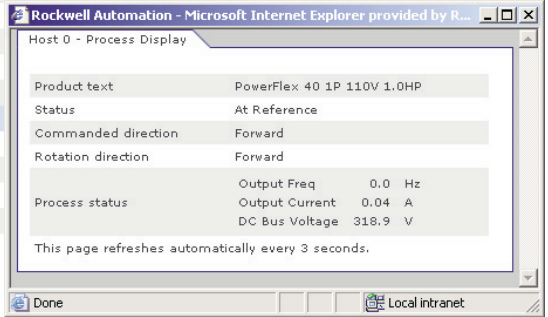

# AUTO-REFRESH PROCESS DISPLAY CONFIGURATION

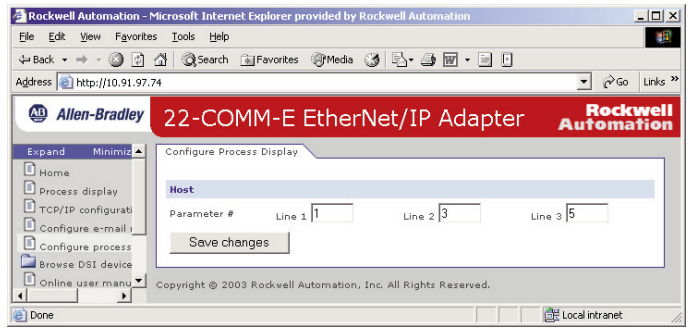

# EXAMPLE FAULT NOTIFICATION EMAIL

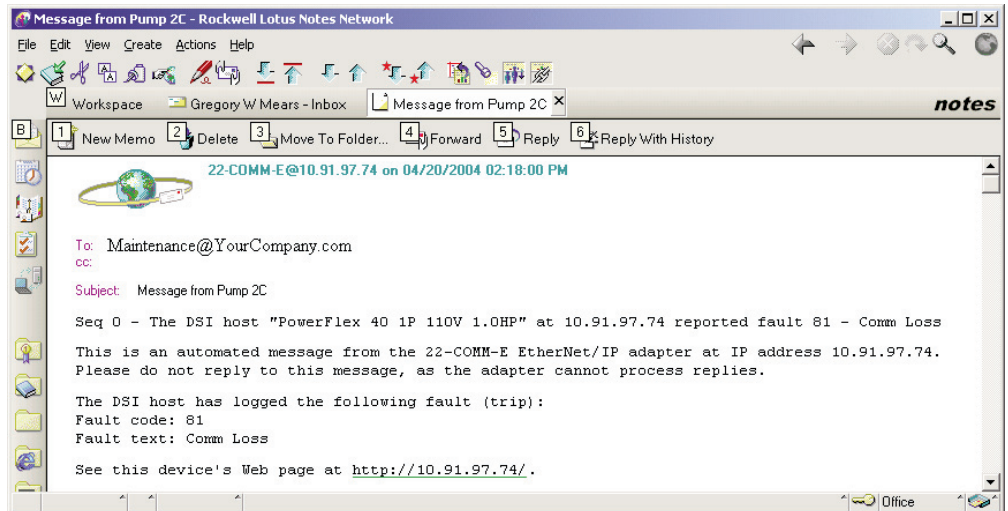



# PRODUCT PROFILE

## 22-COMM-L LonWorks® ADAPTER



The PowerFlex® DSI LonWorks™ adapter provides an internal LonWorks connection for PowerFlex 40 and PowerFlex 400 drives. It can also be used with other Allen-Bradley products that support a DSI adapter, such as the DSI External Communications Kit (22-XCOMM-DC-BASE) which enables PowerFlex 4 drives to connect to a LonWorks network. (PowerFlex 4 drives cannot support an internally-mounted adapter.) The adapter provides a means to control, configure and collect data over a LonWorks network.

### PRODUCT HIGHLIGHTS

**Internal Mount** – The adapter mounts internal to the drive to save panel space, and is field installable. PowerFlex 40 B frame drives require an additional front cover 22B-CCB, PowerFlex 40 C frame drives require 22B-CCC and PowerFlex 400 C frame drives require 22C-CCC.

**Multiple Configuration Tool Options** – A number of configuration tools can be used to configure the adapter and the connected drive. These tools include the PowerFlex DSI HIM, or drive-configuration software such as DriveExplorer™ or DriveExecutive™ through a 22-SCM-232 or 1203-USB converter.

**LonMark Functional Profile** – “Variable Speed Motor Drive: 6010” Support – The adapter supports the standard functional profile used by the HVAC industry for drives, which provides a common set of system network variables and configuration properties.

**Additional “Manufacturer Defined” Network Variables** – Additional “Manufacturer Defined” network variables are also provided:

- Parameter Read/Write
- Metering
- Configuration

**Resource Files** – The following resource files are included on 3.5” disk with the adapter:

- XIF File
- Type File (TYP)
- Format File (FMT)
- Language File (ENU)
- Functional Profile Template (FPT)

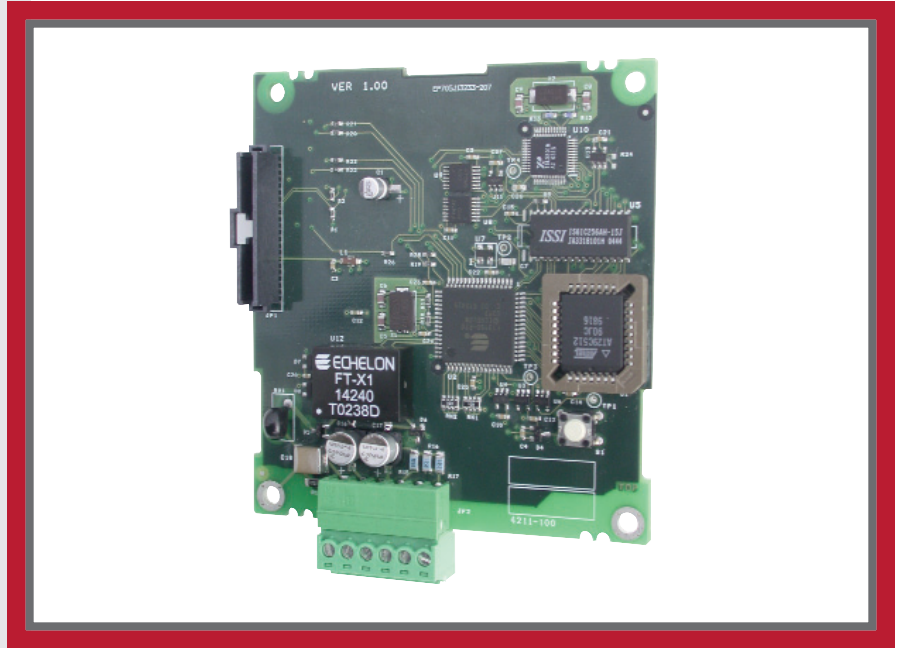

**User Configurable Fault Responses** – Selects the action that the adapter and drive will take for the following two conditions:

- Idle Fault Action – the scanner is idle (controller in program mode)
- Comm Fault Action – network communications have become disrupted

Available actions include:

- Fault – the drive is faulted and stopped
- Stop – the drive is stopped using the current deceleration rate and is not faulted
- Zero Data – the adapter zeros the I/O data transmitted to the drive
- Hold Last – the adapter continues sending the I/O data prior to the fault and the drive continues in its present state
- Send Fault Configuration – the user specifies the Logic Command and Speed Reference data that is sent to the drive, allowing complete flexibility in configuring a fault action

**Diagnostics** – Built-in diagnostics allow drive-side troubleshooting of the network connection using a PowerFlex DSI HIM, DriveExplorer or DriveExecutive. View actual Logic Command/Speed Reference and Logic Status/Speed Feedback data being transmitted to and from the controller.

**Flash Upgradeable** – The adapter can be flash updated in the field using Third-party software tools such as Echelon® LonMaker™ for Windows or the LOADAPP Neuron Chip Application Download Utility to take advantage of new firmware features as they become available.

# PARAMETERS

No.	Name	Description
01	Send Service Pin	Broadcasts a LON Service Pin message from the Neuron Chip to provide the Neuron ID.
02	Neuron State	Displays the state of the Neuron Chip
03	Reset Module	Resets the adapter or sets the adapter parameters to factory default.
04	Neuron ID	Displays the Neuron Chip ID.
05	Clear Counters	Clears the network diagnostic counters.
06	Comm Flt Action	Sets the action that the adapter will take if it detects that network communications have been disrupted.
07	Flt Cfg Logic	Sets the Logic Command data that is sent to the drive if Parameter 08 – [Comm Flt Action] is set to “Send Flt Cfg” and communications are disrupted.
08	Flt Cfg Ref	Sets the Speed Reference data that is sent to the drive if Parameter 08 – [Comm Flt Action] is set to “Send Flt Cfg” and communications are disrupted.
09	Idle Flt Action	Sets the action that the adapter and drive will take if the adapter detects that the controller is in program mode. This setting is effective only if I/O that controls the drive is transmitted through the adapter.
10	Idle Cfg Logic	Sets the Logic Command data that is sent to the drive if Parameter 09 – [Idle Flt Action] is set to “Send Flt Cfg” and the controller is in program mode.
11	Idle Cfg Ref	Sets the Speed Reference data that is sent to the drive if Parameter 09 – [Idle Flt Action] is set to “Send Flt Cfg” and the controller is in program mode.
12	RcvHrtBeat Time	Sets the time used as a Receive Heartbeat timer and triggers the fault action in Parameter 06 – [Comm Flt Action].

# RESOURCE FILES

The resource files can also be downloaded at:  
<http://www.ab.com/drives/22-comm/22-comm-1>

# SPECIFICATIONS

Communications	Drive	Protocol	LonWorks
		Data Rate	78 Kbps
Electrical	Drive	Protocol	DSI
	Consumption	Drive (DSI) Network	50 mA at 5 VDC N/A
Regulatory Compliance		UL	UL508C
		cUL	CAN/CSA C22.2 No. 14-M91
		CE	EN61800-6-4: 2001, EN61000-6-2: 2001

# VARIABLE SPEED MOTOR DRIVE PROFILES

## Node Object

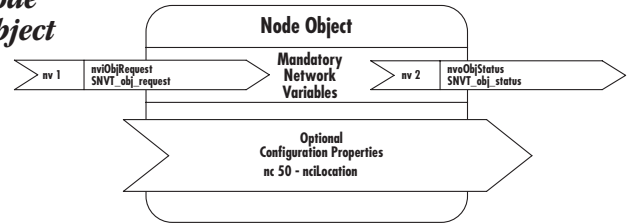

## Drive Object

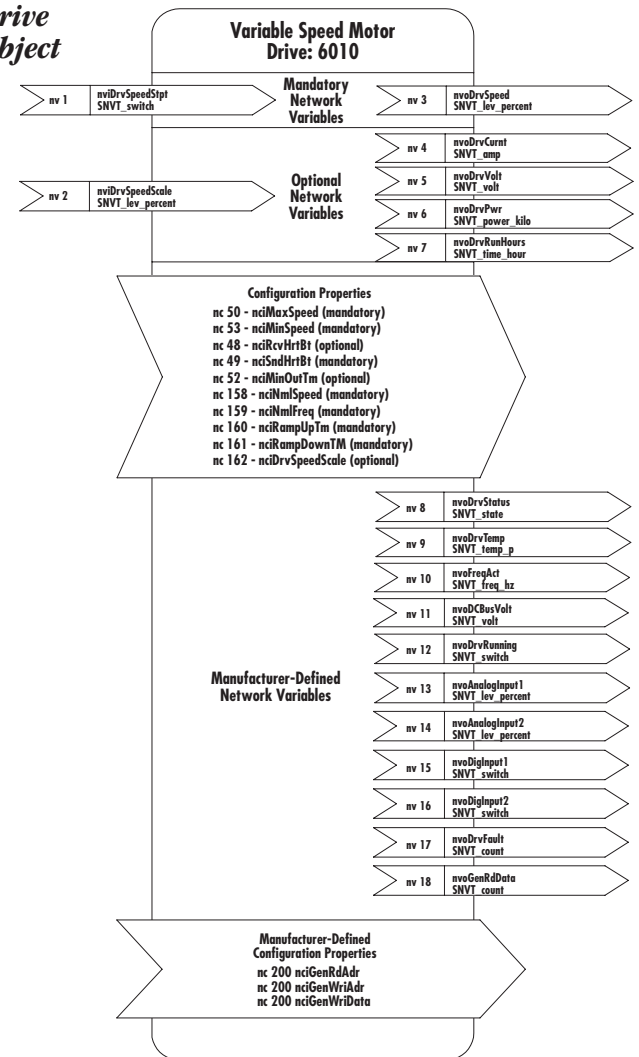

# PRODUCT PROFILE

## 22-COMM-P PROFIBUS DP™ ADAPTER



The PowerFlex® 22-COMM-P adapter provides a PROFIBUS DP network connection for PowerFlex 40 and 400 AC drives and other DSI-based host devices with an internal communications slot. The adapter provides a means to control, configure and collect data over a PROFIBUS DP network.

### PRODUCT HIGHLIGHTS

**Internal Mount** – The adapter mounts internal to the drive to save panel space, and is field installable. PowerFlex 40 B frame drives require 22B-CCB, PowerFlex 40 C frame drives require 22B-CCC and PowerFlex 400 C frame drives require 22C-CCC.

**Configuration Switches** – The adapter has DIP switches for setting the node address (1-127), and jumpers for byte swapping (Intel or Motorola format) and Single/Multi-Drive modes.

**Multiple Configuration Tool Options** – A number of configuration tools can be used to configure the adapter and the connected drive. These tools include the PowerFlex HIM, or drive configuration software such as DriveExplorer™ or DriveExecutive™.

**Single/Multi-Drive Operation** – The adapter can be used in two modes:

- Single – 1 network node consists of 1 drive.
- Multi-Drive – 1 network node can contain up to 5 drives.

In this cost-saving configuration, the 22-COMM-P is installed in a PowerFlex 40 or 400 drive and up to four additional PowerFlex 4, 40 or 400 drives can be connected over their built-in RS-485 ports. Each drive can be individually controlled, configured, and monitored through the single PROFIBUS DP connection.

**I/O Messaging** – I/O messaging is used to transfer time-critical data, such as data that controls the drive. The following data can be sent and received by the adapter:

- Logic Command/Reference
- Logic Status/Feedback

It also supports synch and freeze modes.

**Explicit Messaging** – Explicit messaging involves non time-critical information that is typically triggered by the application (ladder program in a controller, etc.).

The adapter supports:

- Reading/writing of drive parameters
- Reading/writing of adapter parameters

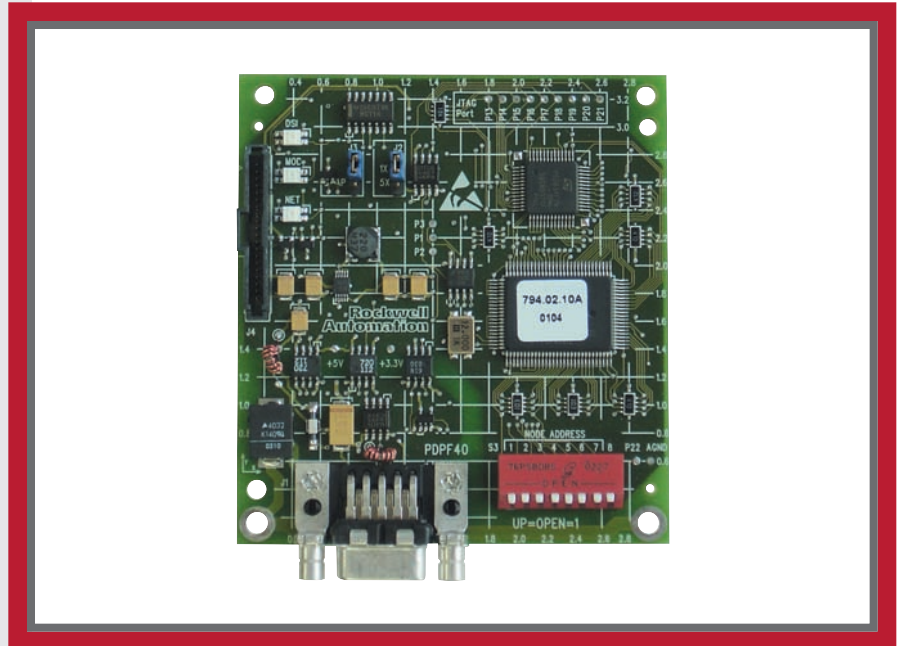

**Compliance Tested** – PNO compliance tested

**User Configurable Fault Responses** – Selects the action that the adapter and drive will take for the following two conditions:

- Idle Fault Action – the scanner is idle (controller in program mode)
- Comm Fault Action – network communications have become disrupted

Available actions include:

- `Fault – the drive is faulted and stopped
- Stop – the drive is stopped using the current deceleration rate and is not faulted
- Zero Data – the adapter zeros the I/O data transmitted to the drive
- Hold Last – the adapter continues sending the I/O data prior to the fault and the drive continues in its present state
- Send Fault Configuration – the user specifies the Logic Command and Reference data that is sent to the drive, allowing complete flexibility in configuring a fault action

**Diagnostics** – Built-in diagnostics allow drive-side troubleshooting of the network connection using a PowerFlex DSI HIM, DriveExplorer or DriveExecutive. View actual Logic Command/Reference and Logic Status/Feedback data being transmitted to and from the controller.

**Flash Upgradeable** – The adapter can be flash updated in the field using DriveExplorer, DriveExecutive or ControlFLASH to take advantage of new firmware features as they become available.



## PARAMETERS

No.	Name	Description
01	Mode	Displays the mode selected by the J2 jumper (Single or Multi-Drive).
02	Reserved	
03	Reserved	
04	P-DP Addr Actual	Displays the node address actually used by the adapter.
05	P-DP Rate Actual	Displays the data rate actually used by the adapter.
06	Reserved	
07	Reserved	
08	Reset Module	Used to reset the adapter or set defaults.
09	Comm Flt Action	Sets the action that the adapter will take if it detects that communications have been disrupted.
10	Idle Flt Action	Sets the action that the adapter will take if it detects that the scanner is idle.
11	DSI I/O Config	Selects the I/O that is transferred through the adapter.
12	DSI I/O Active	Displays the I/O that the adapter is actively transmitting.
13	Flt Cfg Logic	Sets the data that is sent to the drive if any of the following is true:
14	Flt Cfg Ref	<ul style="list-style-type: none"> <li>Parameter 09 - [Comm Flt Action] is set to Send Flt Cfg and communications are disrupted.</li> <li>Parameter 10 - [Idle Fault Action] is set to Send Flt Cfg and the scanner is put into Program mode.</li> </ul>
15	Reserved	
16	Reserved	
17	Drv 0 Addr	Sets the corresponding node addresses of the daisy-chained drives used in Multi-Drive mode.
18	Drv 1 Addr	
19	Drv 2 Addr	
20	Drv 3 Addr	
21	Drv 4 Addr	
22	Reserved	
23	Reserved	
24	P-DP State	Displays the state of the PROFIBUS controller.

## GSD FILE

The GSD file is provided on 3.5" disk with the adapter and can be downloaded at: <http://www.ab.com/drives/22-comm/22-comm-p>

## SPECIFICATIONS

Communications	Network	Protocol	PROFIBUS DP
		Data Rates	9600 – 12 Mbps (autobauds)
	Drive	Protocol	DSI
Electrical	Consumption	Drive (DSI)	370 mA at 5 VDC
		Network	N/A
Regulatory Compliance		UL	UL508C
		cUL	CAN/CSA C22.2 No. 14-M91
		CE	EN50178 and EN61800-3

## EXAMPLE I/O IMAGE - SINGLE MODE

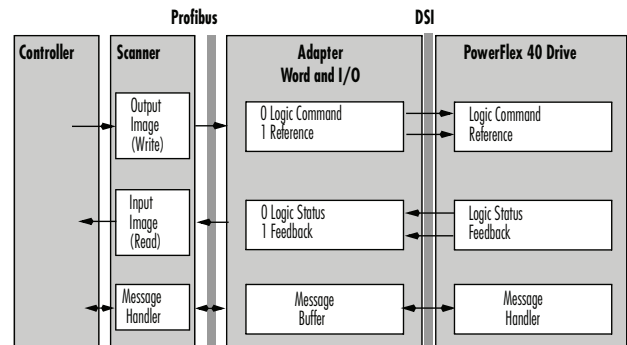

## EXAMPLE I/O IMAGE - MULTI-DRIVE MODE

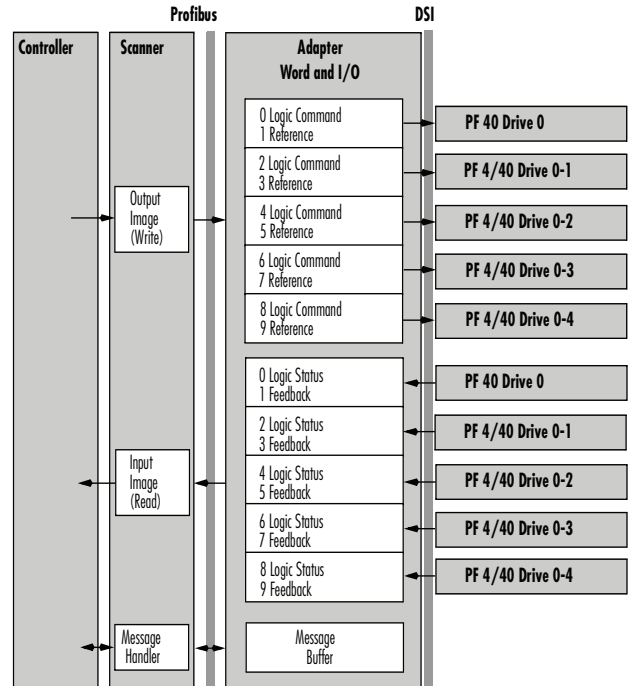



# PRODUCT PROFILE

## 22-SCM-232 RS-232 DF1™ MODULE

The PowerFlex® 22-SCM-232 provides an RS-232 DF1 connection for PowerFlex 4 and 40 AC drives and other DSI-based host devices. The module provides a means for drive software tools, such as DriveExplorer™ and DriveExecutive™, to communicate with drive products. It also allows various Allen-Bradley® controllers, from MicroLogix™ to ControlLogix®, to control and read/write data to PowerFlex 4 and 40 AC drives.

### PRODUCT HIGHLIGHTS

**External Mount** – The module connects externally and is powered by the drive.

**DSI Routing** – Allows DriveExplorer to connect to a PowerFlex 4 and 40 AC drive using a 22-SCM-232 serial converter and then route out over EtherNet/IP, DeviceNet, or RS-485 to access other PowerFlex 4 and 40 AC drives (1-to-many connection). This eliminates the need for a separate network connection and interface.

**DriveExplorer Lite Included** –

A DriveExplorer Lite CD is included with the 22-SCM-232. DriveExplorer Lite is freeware and can also be downloaded at:

[http://www.ab.com/drives/driveexplorer/free\\_download.html](http://www.ab.com/drives/driveexplorer/free_download.html)

**Modbus RTU Master Support** –

The module can also be configured to operate as a Modbus RTU Master. The module converts both the media (RS-232 to RS-485) and the protocol (DF1 to Modbus RTU). Any Allen-Bradley controller capable of originating and receiving DF1 messages via its front port can be used to control and read/write data on a Modbus RTU network:

- MicroLogix 1000 (Series C or later discrete controllers, and all analog controllers)
- MicroLogix 1200/1500
- SLC 5/03, 5/04, 5/05
- PLC-5
- ControlLogix, CompactLogix

**PowerFlex®**  
Communications



**Modbus RTU Pass-Thru Support** – The module can also be configured to operate as a RS-232 (DB-9) to RS-485 (RJ45) serial converter, where Modbus RTU messages pass-thru both directions in the module.

**Flash Upgradeable** – The module can be flash updated in the field using DriveExplorer, DriveExecutive or ControlFLASH to take advantage of new firmware features as they become available. The module is also the primary connection mechanism for flashing drives and other peripherals.

### ACCESSORIES

Do you have a PC with only a USB connection? Use a USB to Serial adapter, such as an Allen-Bradley 9300-USBS, to connect to the RS-232 side of the 22-SCM-232. The adapter is a small, portable unit with no AC power required. It has also been tested with Allen-Bradley DriveExplorer and DriveExecutive software tools.

Do you want to connect to a drive without having to open the enclosure door? Use a GracePort™ interface, such as a P-A20-B3RX (Nema 4/12 interface) or P-A20-F3RO (Nema 4/12 interface with AC outlet), available from Grace Engineered Products Inc. (<http://www.grace-eng.com>).

## PARAMETERS

No.	Name	Description
01	Adapter Cfg	Sets the operation of the serial converter (Auto, Master, Slave, RTU Master, and RTU Pass-thru).
02	DF1 Addr Cfg	Configures the DF1 address used for the serial converter.
03	DF1 Rate Cfg	Configures the data rate used for the serial port.
04	Comm Flt Action	Sets the action that the module will take if it detects that communications have been disrupted.
05	Reset Module	Used to reset the adapter or reset defaults.
06	Clear DF1 Counts	Used to clear the DF1 statistical parameters (7-15).
07	DF1 Packets Sent	Displays the number of DF1 packets sent by the serial converter.
08	DF1 Packets Rcvd	Displays the number of DF1 packets received by the serial converter.
09	Undelivered Msgs	Displays the number of DF1 packets sent by the serial converter and not acknowledged.
10	ENQs Sent	Displays the number of ENQs sent by the serial converter.
11	ENQs Received	Displays the number of ENQs received by the serial converter.
12	NAKs Received	Displays the number of NAKs received by the serial converter.
13	NAK Bad Packet	Displays the number of NAKs received by the serial converter because of bad packets.
14	NAK No Memory	Displays the number of NAKs received by the serial converter because of insufficient buffer memory.
15	Duplicate Msgs	Displays the number of duplicate messages sent by the serial converter.
16	DF1 Addr Actual	Displays the actual DF1 address used by the serial converter.
17	DF1 Rate Actual	Displays the actual data rate used by the serial converter.

## SPECIFICATIONS

Communications	Network	Protocol	NRS-232: DF1, Modbus RTU RS-485: DSI, Modbus RTU
		Data Rates	9600 – 38,400 bps
	Drive	Protocol	DSI, Modbus RTU
		Data Rates	19.2 Kbps
Electrical	Consumption	Drive (DSI)	170mA at 5V DC
		Network	N/A
Regulatory Compliance		UL	UL508C
		cUL	CAN/CSA C22.2 No. 14-M91
		CE	EN50178 and EN61800-3
		CTick	AS/NZS 2064, Group 1, Class A

## DRIVEEXPLORER LITE

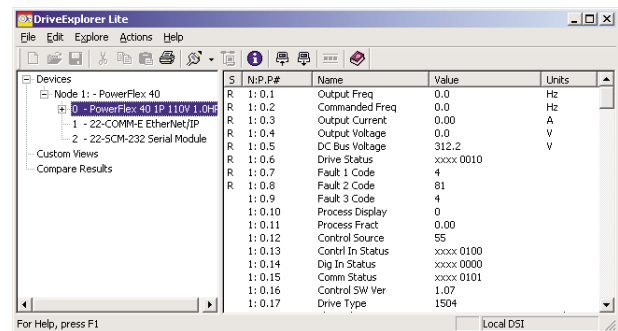

## POINT-TO-POINT SYSTEM EXAMPLE

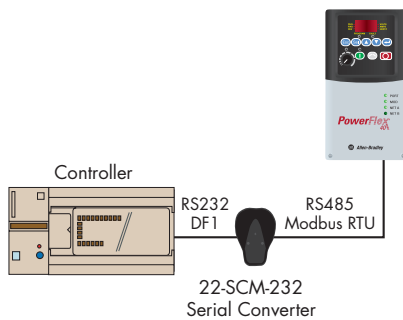

## SOFTWARE TOOL CONNECTION EXAMPLE

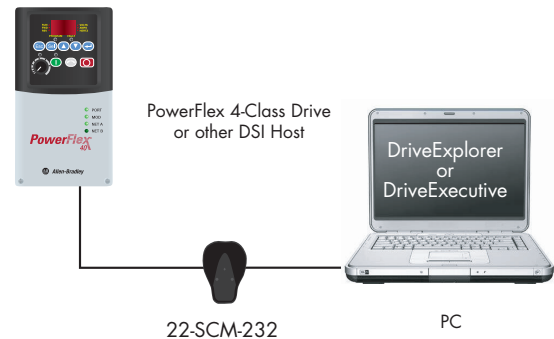

## MULTIPLE-DRIVE SYSTEM EXAMPLE

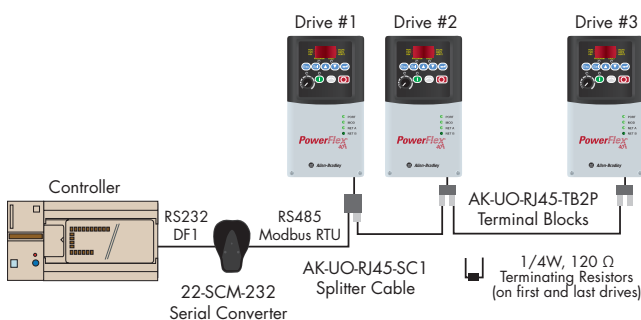

# PRODUCT PROFILE

## 1769-SM2 COMPACT I/O™ MODULE

**PowerFlex®**  
Communications

The 1769-SM2 module provides a direct 1769 platform connection for PowerFlex® 4, 40, and 400 AC drives, other DSI-based host devices, and Modbus RTU-based host devices such as PowerFlex 70, 700, and 700S AC drives equipped with 20-COMM-H adapters. The 1769-SM2 can be used with MicroLogix™ 1500 and CompactLogix™ controllers, and remote 1769-based nodes such as the 1769-ADN DeviceNet™ adapter to control, configure, and collect data.

### PRODUCT HIGHLIGHTS

**1769 Platform Connectivity** – The module can be used in 1769-based systems, such as:

- MicroLogix 1500 controllers
- CompactLogix controllers
- Remote 1769-based node adapters (1769-ADN DeviceNet, etc.)

**Three DSI/Modbus RTU Channels** – 3 channels are provided and can be configured for:

- Single-Drive Mode – One PowerFlex 4, 40 or 400 AC drive per channel (3 drives total)
- Multi-Drive Mode – Up to five PowerFlex 4, 40 or 400 AC drives per channel (15 drives total)
- Modbus RTU Master – Connect Modbus RTU Slave devices, including 3rd Party devices and PowerFlex 70, 700, and 700S AC drives equipped with 20-COMM-H adapters

**I/O Messaging** – I/O messaging is used to transfer time-critical data, such as data that controls the drive. The following data can be sent and received by the adapter:

- Logic Status/Speed Feedback
- Logic Command/Speed Reference

**Explicit Messaging** – Explicit messaging involves non time-critical information that is typically triggered by the application (ladder program in a controller, etc.). The adapter supports the reading/writing of parameters, etc. in the drive and to any connected DSI peripheral(s).

**Multiple Configuration Tool Options** – A number of configuration tools can be used to configure the adapter and the connected drive.

When the 1769-SM2 is set to “Parameter” mode, tools like the PowerFlex DSI HIM, or drive-configuration software such as DriveExplorer™ or DriveExecutive™ can be used. When set to “Controller” mode, software tools such as RSLogix 500™, RSLogix 5000™ or RSNetWorx for DeviceNet™ can be used.



**User Configurable Fault Responses** – Selects the action that the adapter and drive will take for the following two conditions:

- Idle Fault Action – the scanner is idle (controller in program mode)
- Comm Fault Action – network communications have become disrupted

Available actions include:

- Fault – the drive is faulted and stopped
- Stop – the drive is stopped using the current deceleration rate and is not faulted
- Zero Data – the adapter zeros the I/O data transmitted to the drive
- Hold Last – the adapter continues sending the I/O data prior to the fault and the drive continues in its present state
- Send Fault Configuration – the user specifies the Logic Command, Speed Reference, and Datalink data that is sent to the drive, allowing complete flexibility in configuring a fault action

**Diagnostics** – Built-in diagnostics allow drive-side troubleshooting of the network connection using a PowerFlex DSI HIM, DriveExplorer or DriveExecutive. View actual Logic Status/Speed Feedback and Logic Command/Speed Reference data being transmitted to and from the controller.

**Flash Upgradeable** – The adapter can be flash updated in the field using DriveExplorer, DriveExecutive or ControlFLASH to take full advantage of new firmware features as they become available.

## PARAMETERS

No.	Name	Description
01	Config Mode	Displays the module's configuration mode.
02	DSI Mode	Displays the module's operating mode (single or multi-drive).
03	Reset Module	Used to reset the module or set defaults.
04	Idle Action 1	Sets the action that the module and CH1 drive take if the module detects that the controller was switched to Program mode or Test mode.
05	Flr Cfg Logic 1	Sets the data that is sent to the CH1 drive if Parameter 04 - [Idle Action 1] is set to "Send Flr Cfg" and the controller is put into Program or Test mode.
06	Flr Cfg Ref 1	
07	DSI I/O Cfg 1	Sets the configuration of the CH1 drives that are active in the Multi-drive mode.
08	DSI I/O Act 1	Displays the CH1 drives that are active in the Multi-drive mode.
09	Drv 0 Addr 1	Sets the corresponding node addresses of the daisy-chained CH1 drives when the module Operating Mode Switch (SW2) is set for Multi-drive operation.
10	Drv 1 Addr 1	
11	Drv 2 Addr 1	
12	Drv 3 Addr 1	
13	Drv 4 Addr 1	
14	RTU Baud Rate 1	Sets the baud rate used by the CH1 drives when the module is operating in the Multi-drive mode and Parameter 07 - [DSI I/O Cfg 1] is set to "RTU Master".
15	RTU Parity 1	Sets the parity used by the CH1 drives when the module is operating in the Multi-drive mode and Parameter 07 - [DSI I/O Cfg 1] is set to "RTU Master".
16	RTU Rx Delay 1	Sets the inter-character delay used by the CH1 drives to detect the end of a receive packet when the module is operating in the Multi-drive mode and Parameter 07 - [DSI I/O Cfg 1] is set to "RTU Master".
17	RTU Tx Delay 1	Sets the inter-frame delay used by the CH1 drives to delay the sending of a transmit packet when the module is operating in the Multi-drive mode and Parameter 07 - [DSI I/O Cfg 1] is set to "RTU Master".
18	RTU MsgTimeout 1	Sets the amount of time in seconds that the module will wait for a response from a Modbus RTU CH1 slave when the module is operating in the Multi-drive mode and Parameter 07 - [DSI I/O Cfg 1] is set to "RTU Master".
19	Idle Action 2	Sets the action that the module and CH2 drive take if the module detects that the controller was switched to Program mode or Test mode.
20	Flr Cfg Logic 2	Sets the data that is sent to the CH2 drive if Parameter 19 - [Idle Action 2] is set to "Send Flr Cfg" and the controller is put into Program or Test mode.
21	Flr Cfg Ref 2	
22	DSI I/O Cfg 2	Sets the configuration of the CH2 drives that are active in the Multi-drive mode.
23	DSI I/O Act 2	Displays the CH2 drives that are active in the Multi-drive mode.
24	Drv 0 Addr 2	Sets the corresponding node addresses of the daisy-chained CH2 drives when the module Operating Mode Switch (SW2) is set for Multi-drive operation.
25	Drv 1 Addr 2	
26	Drv 2 Addr 2	
27	Drv 3 Addr 2	
28	Drv 4 Addr 2	
29	RTU Baud Rate 2	Sets the baud rate used by the CH2 drives when the module is operating in the Multi-drive mode and Parameter 22 - [DSI I/O Cfg 2] is set to "RTU Master".
30	RTU Parity 2	Sets the parity used by the CH2 drives when the module is operating in the Multi-drive mode and Parameter 22 - [DSI I/O Cfg 2] is set to "RTU Master".
31	RTU Rx Delay 2	Sets the inter-character delay used by the CH2 drives to detect the end of a receive packet when the module is operating in the Multi-drive mode and Parameter 22 - [DSI I/O Cfg 2] is set to "RTU Master".
32	RTU Tx Delay 2	Sets the inter-frame delay used by the CH2 drives to delay the sending of a transmit packet when the module is operating in the Multi-drive mode and Parameter 22 - [DSI I/O Cfg 2] is set to "RTU Master".
33	RTU MsgTimeout 2	Sets the amount of time in seconds that the module will wait for a response from a Modbus RTU CH2 slave when the module is operating in the Multi-drive mode and Parameter 22 - [DSI I/O Cfg 2] is set to "RTU Master".
34	Idle Action 3	Sets the action that the module and CH3 drive take if the module detects that the controller was switched to Program mode or Test mode.
35	Flr Cfg Logic 3	Sets the data that is sent to the CH3 drive if Parameter 34 - [Idle Action 3] is set to "Send Flr Cfg" and the controller is put into Program or Test mode.
36	Flr Cfg Ref 3	
37	DSI I/O Cfg 3	Sets the configuration of the CH3 drives that are active in the Multi-drive mode.
38	DSI I/O Act 3	Displays the CH3 drives that are active in the Multi-drive mode.
39	Drv 0 Addr 3	Sets the corresponding node addresses of the daisy-chained CH3 drives when the module Operating Mode Switch (SW2) is set for Multi-drive operation.
40	Drv 1 Addr 3	
41	Drv 2 Addr 3	
42	Drv 3 Addr 3	
43	Drv 4 Addr 3	
44	RTU Baud Rate 3	Sets the baud rate used by the CH3 drives when the module is operating in the Multi-drive mode and Parameter 37 - [DSI I/O Cfg 3] is set to "RTU Master".
45	RTU Parity 3	Sets the parity used by the CH3 drives when the module is operating in the Multi-drive mode and Parameter 37 - [DSI I/O Cfg 3] is set to "RTU Master".
46	RTU Rx Delay 3	Sets the inter-character delay used by the CH3 drives to detect the end of a receive packet when the module is operating in the Multi-drive mode and Parameter 37 - [DSI I/O Cfg 3] is set to "RTU Master".
47	RTU Tx Delay 3	Sets the inter-frame delay used by the CH3 drives to delay the sending of a transmit packet when the module is operating in the Multi-drive mode and Parameter 37 - [DSI I/O Cfg 3] is set to "RTU Master".
48	RTU MsgTimeout 3	Sets the amount of time in seconds that the module will wait for a response from a Modbus RTU CH3 slave when the module is operating in the Multi-drive mode and Parameter 37 - [DSI I/O Cfg 3] is set to "RTU Master".

## SPECIFICATIONS

Communications	Network	Protocol	DSI/Modbus RTU
		Data Rates	DSI: 19.2 Kbps Modbus RTU: 300 - 38400 bps
Electrical	Consumption	Module Channel	350 mA at 5 VDC 0 mA at 24 VDC (supplied by Compact I/O power supply)
Regulatory Compliance		UL cUL CE CTick	UL508C CAN/CSA C22.2 No. 14-M91 EN50081-2 and EN61000-6-2 AS/NZS 2064, 1997, Group 1, Class A

## EXAMPLE I/O IMAGE

### Single-Drive Mode

Output Image	Input Image	Word		
		CH1	CH2	CH3
Module Control Word	Module Status Word		0	
Logic Command	Logic Status	1	3	5
Speed Reference	Speed Feedback	2	4	6

### Multi-Drive Mode

	Output Image	Input Image	Word		
			CH1	CH2	CH3
	Module Control Word	Module Status Word	0		
Drive 0	Logic Command	Logic Status	1	11	21
	Speed Reference	Speed Feedback	2	12	22
Drive 1	Logic Command	Logic Status	3	13	23
	Speed Reference	Speed Feedback	4	14	24
Drive 2	Logic Command	Logic Status	5	15	25
	Speed Reference	Speed Feedback	6	16	26
Drive 3	Logic Command	Logic Status	7	17	27
	Speed Reference	Speed Feedback	8	18	28
Drive 4	Logic Command	Logic Status	9	19	29
	Speed Reference	Speed Feedback	10	20	30

# EXAMPLE SYSTEMS

## Example MicroLogix 1500 Single Mode System Arrangement

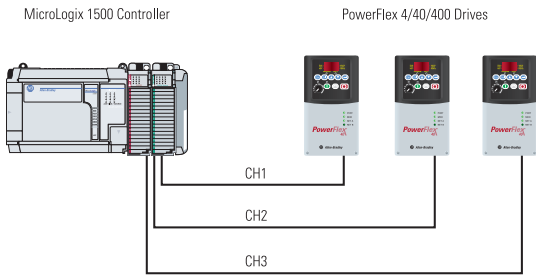

## Example MicroLogix 1500 Multi-Drive Mode System Arrangement

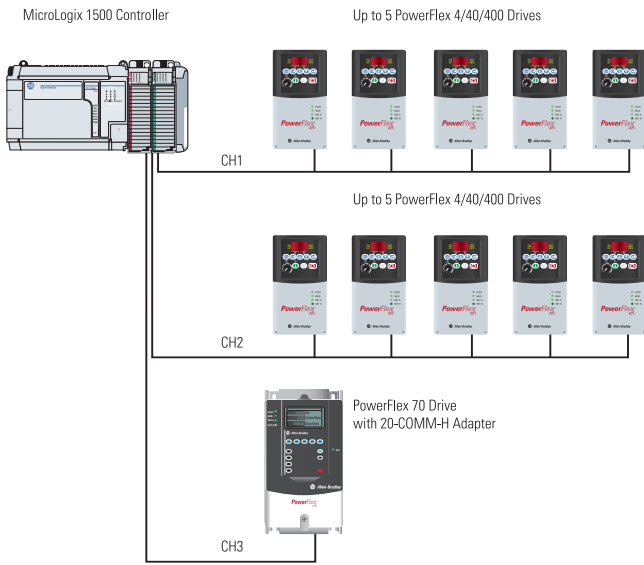

## Example CompactLogix Multi-Drive Mode System Arrangement

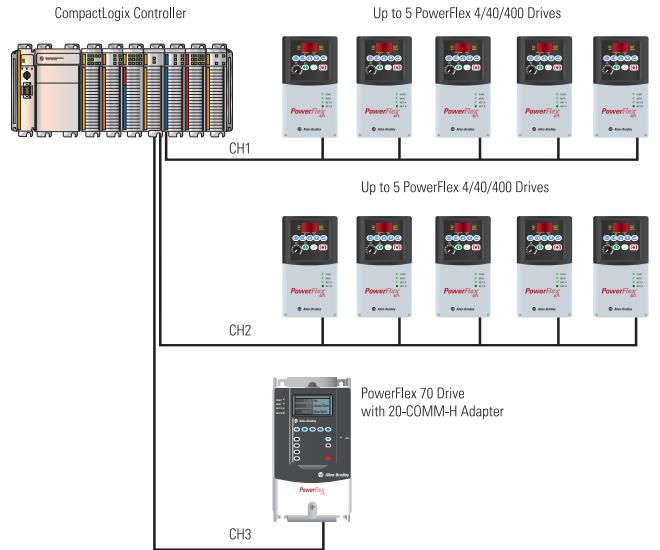

## Example ControlLogix/1769-ADN DeviceNet Adapter Single Mode System Arrangement

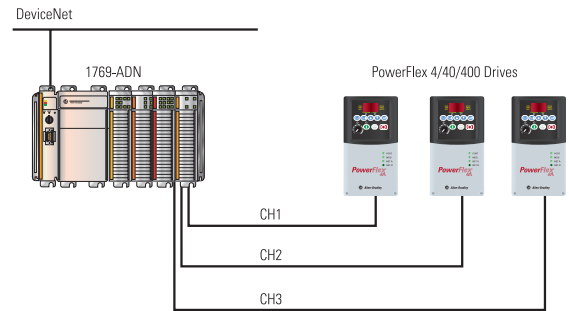

## Example CompactLogix Single Mode System Arrangement

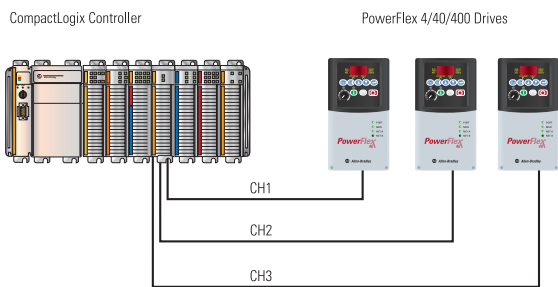



# PRODUCT PROFILE

## DSI EXTERNAL COMMUNICATIONS KIT

The DSI External Communications Kit (22-XCOMM-DC-BASE) provides a network connection for PowerFlex® 4, 40, and 400 AC drives. Each kit can serve up to 5 drives via their RS-485 ports.

### PRODUCT HIGHLIGHTS

**Multiple Network Connectivity** – Provides a network connection for DSI-based PowerFlex 4, 40, and 400 AC drives. Each drive connected to a kit can be independently controlled, and have its parameters accessed either through explicit messaging, or by using software tools such as DriveExplorer™ or DriveExecutive™.

The kit is for use with only the following Allen-Bradley communication adapters (sold separately):

- 22-COMM-B BACnet® MS/TP
- 22-COMM-C ControlNet®
- 22-COMM-E EtherNet/IP™
- 22-COMM-D DeviceNet™
- 22-COMM-L LonWorks®
- 22-COMM-P PROFIBUS DP™

**Universal Mounting** – Direct panel, DIN rail, even Zero-Stacking™ (side-by-side) mounting is possible using the all-aluminum, EMI noise-immune enclosure.

**Versatile Power Connections** – Connect either a 24 VDC power supply to the kit's convenient removable terminal block, or use the Allen-Bradley AC power adapter (20-XCOMM-AC-PS1, sold separately) that comes with interchangeable region plugs (US, UK, Europe, and Australia). The kit can also be daisy-chained to provide power for additional kits.

**PowerFlex®**  
Communications



### EXAMPLE SYSTEM OVERVIEW

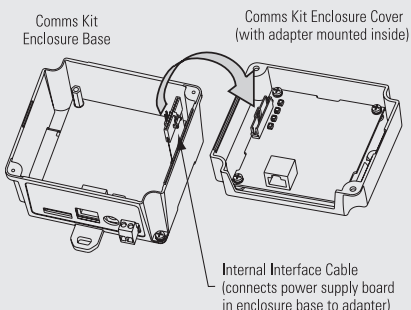
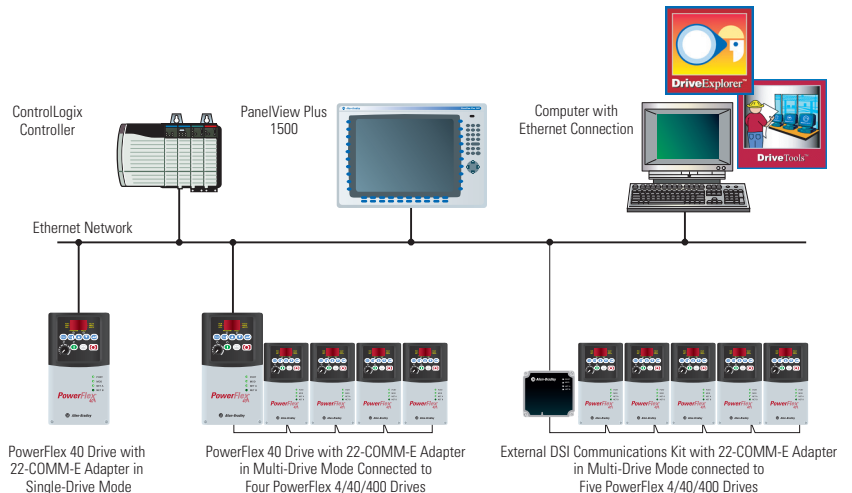

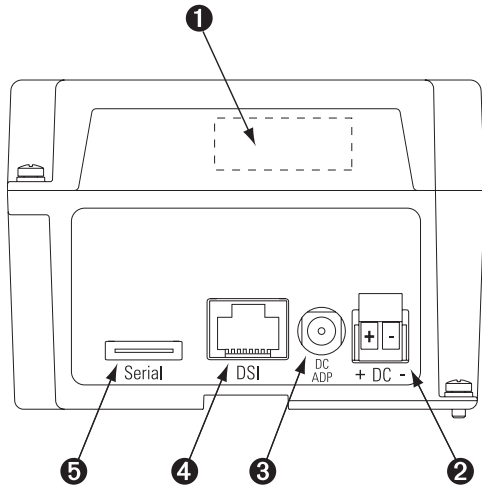

Item	Connector	Description
1	Network	Network connection for communication adapter
2	24 VDC	Connection for 24 VDC power source
3	AC-to-DC	Connection for 20-XCOMM-AC-PS1 power adapter
4	DSI	DSI connection for 22-RJ45CBL-C** cable or AK-UO-RJ45-TB2P terminal block adapter
5	Serial	Connection for 1203-SFC cable to use with PC software tools

## SPECIFICATIONS

Communications	Network	Protocol	Dependent on installed adapter
		Data Rate	Dependent on installed adapter
	Drive	Protocol	DSI
		Data Rate	19.2 Kbps
Electrical	Consumption Network	Drive	None
		EtherNet/IP	None
		DeviceNet	60 mA at 24 VDC
		PROFIBUS DP	None
		BACnet MS/TP	None
		LonWorks	None
		ControlNet	None
DC Power Supply Requirement	22-COMM-B		75 mA at 24 VDC
	22-COMM-C		110 mA at 24 VDC
	22-COMM-D		60 mA at 24 VDC
	22-COMM-E		140 mA at 24 VDC
	22-COMM-L		60 mA at 24 VDC
	22-COMM-P		60 mA at 24 VDC
Compliance		UL	UL508C
		cUL	CAN/CSA C22.2 No. 14-M91
		CE	EN50178 and EN61800-3
		CTick	EN61800-3

## DAISY-CHAINING KITS

You can power additional external communication kits by daisy-chaining them together.

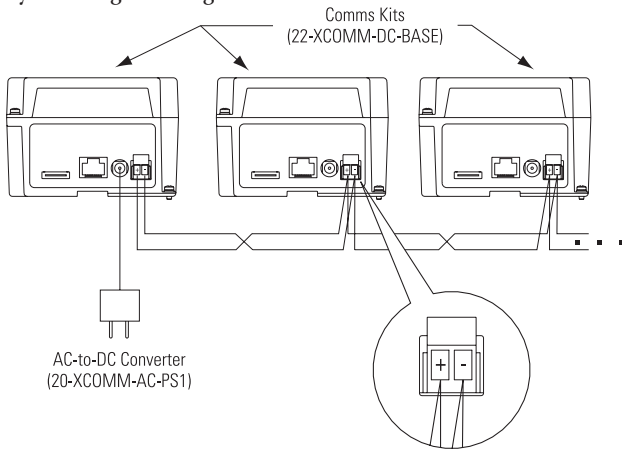

## AC POWER ADAPTER OPTION

The AC power adapter (20-XCOMM-AC-PS1) is an accessory AC-to-DC converter for use with the external communications kit. The converter, which comes with interchangeable plugs, is shown below. The converter connects to any available 100-240 VAC receptacle. Use the appropriate plug for your region:

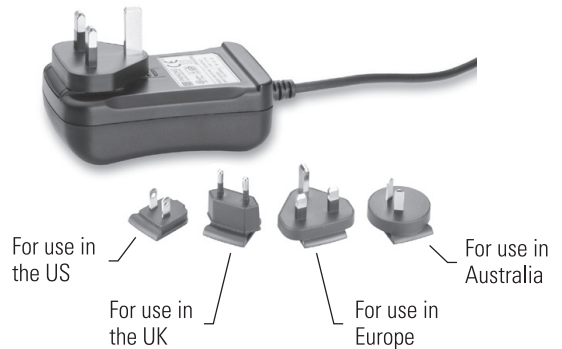



# PRODUCT PROFILE

## DSI WIRELESS INTERFACE MODULE

The DSI Wireless Interface Module (WIM) provides a wireless communication interface between a Pocket PC, laptop computer or desktop computer equipped with Bluetooth® wireless technology, and any Allen-Bradley® product supporting the DSI™ protocol. Connectivity includes the entire PowerFlex® 4-Class Family of drives and peripherals.

### PRODUCT HIGHLIGHTS

**Multiple Enclosure Styles** – The DSI WIM is offered in two different form-factors to meet your environment needs:

- NEMA 1 (cat. no. 22-WIM-N1)
- NEMA 4 (cat. no. 22-WIM-N4S)

**Versatile Mounting** – The NEMA 1 DSI WIM (shown left) can be installed in a NEMA 1 DSI HIM bezel (22-HIM-B1) mounted on the front of an enclosure door. However, if a DSI HIM is still required and already occupies DSI Port 2 on the drive, a DSI splitter cable (AK-U0-RJ45-SC1) can be used.

The NEMA 4 DSI WIM (shown right) is designed for NEMA 4 and permanent-mount applications.

**Multiple Tool Options** – A number of tools can be used to configure and communicate with the DSI WIM and connected drive. These tools include the PowerFlex DSI HIM, or drive-configuration software such as Pocket DriveExplorer™ for Pocket PC, DriveExplorer™ or DriveExecutive™.

**DSI Routing** – Connect point-to-point to a PowerFlex 4-Class drive using the DSI WIM, and then route out over DSI through the built-in RS-485 ports to access other drives on the network (up to 31 drives!). This eliminates the need for a separate network connection and interface.

**Security** – Use the security mode parameter to enable or disable access and the security PIN parameter to set a unique 4-digit pass code number. Together, these parameters prevent “others” from gaining access to parameters in the WIM and connected drive for configuration.



**User Configurable Fault Response** – Selects the action that the DSI WIM and drive will take for the following condition:

- Comm Fault Action – network communications have become disrupted

Available actions include:

- Fault – the drive is faulted and stopped
- Stop – the drive is stopped using the current deceleration rate and is not faulted
- Zero Data – the WIM zeros the I/O data transmitted to the drive
- Hold Last – the WIM continues sending the I/O data prior to the fault and the drive continues in its present state

**Diagnostics** – Built-in diagnostics allow drive-side troubleshooting of the network connection using Pocket DriveExplorer for Pocket PC, DriveExplorer or DriveExecutive. View actual Logic Command/Speed Reference and Logic Status/Speed Feedback data being transmitted to and from the controller.

**Flash Upgradeable** – The DSI WIM can be used to flash update its own firmware, and the firmware of other connected DSI peripherals such as 22-COMM-\* adapters through Pocket DriveExplorer for Pocket PC, DriveExplorer or DriveExecutive to take full advantage of new firmware features as they become available.

## PARAMETERS

No.	Name	Description
01	Adapter Cfg	Sets the operating mode of the WIM.
02	Adapter Type	Displays the present operating mode of the WIM.
03	Drive Addr Cfg	Sets the node address of the WIM for use with the WIM operating mode set with Parameter 01 - [Adapter Cfg].
04	Drive Addr Act	Displays the node address of the drive that the WIM is communicating with when the WIM is in RTU Master mode using Parameter 01 - [Adapter Cfg].
05	Security Mode	Enables/disables the security mode for the WIM, which prevents accessing its parameters and the connected drive for configuration.
06	Security PIN	Sets the PIN number to access WIM parameters for configuration when Parameter 03 - [Security Mode] is set to 1 = PIN Required.
07	Comm Flt Action	Sets the action that the WIM and drive will take if the WIM detects that wireless communications are disrupted. This setting is effective only if I/O that controls the drive is transmitted through the WIM.
08	Reset Module	Resets the adapter or sets parameter defaults.
09	Clear DF1 Counts	Resets the DF1 statistical parameters 10 and 11 to 0 if set to "1 = Clear Counts." This parameter will be reset to "0 = Ready" after a "Clear Counts" command has been performed.
10	DF1 Packets Sent	Displays the number of DF1 packets sent by the WIM. This parameter is normally about equal to the value in parameter 11.
11	DF1 Packets Rcvd	Displays the number of DF1 packets received by the WIM. This parameter is normally about equal to the value in parameter 10.

## SPECIFICATIONS

Radio	Transceiver	Bluetooth v1.1 Compliant
	Frequency	2.4 GHz Frequency Hopping
	Power Range	2.5 mW Maximum RF Output Class II - 10 m (32.8 ft)
Communications	Drive	Protocol Data Rate
		DSI 19.2 Kbps
Electrical	Consumption	Drive (DSI) Network
		170 mA at 5 VDC None
Regulatory Compliance		UL cUL CE CTick FCC ID IC
		UL508C CAN/CSA C22.2 No. 14-M91 EN50178 and EN61800-3 AS/NZS 2064, Group 1, Class A SNT-2XWIMNX 5450A-2XWIMNX

## NETWORK EXAMPLE

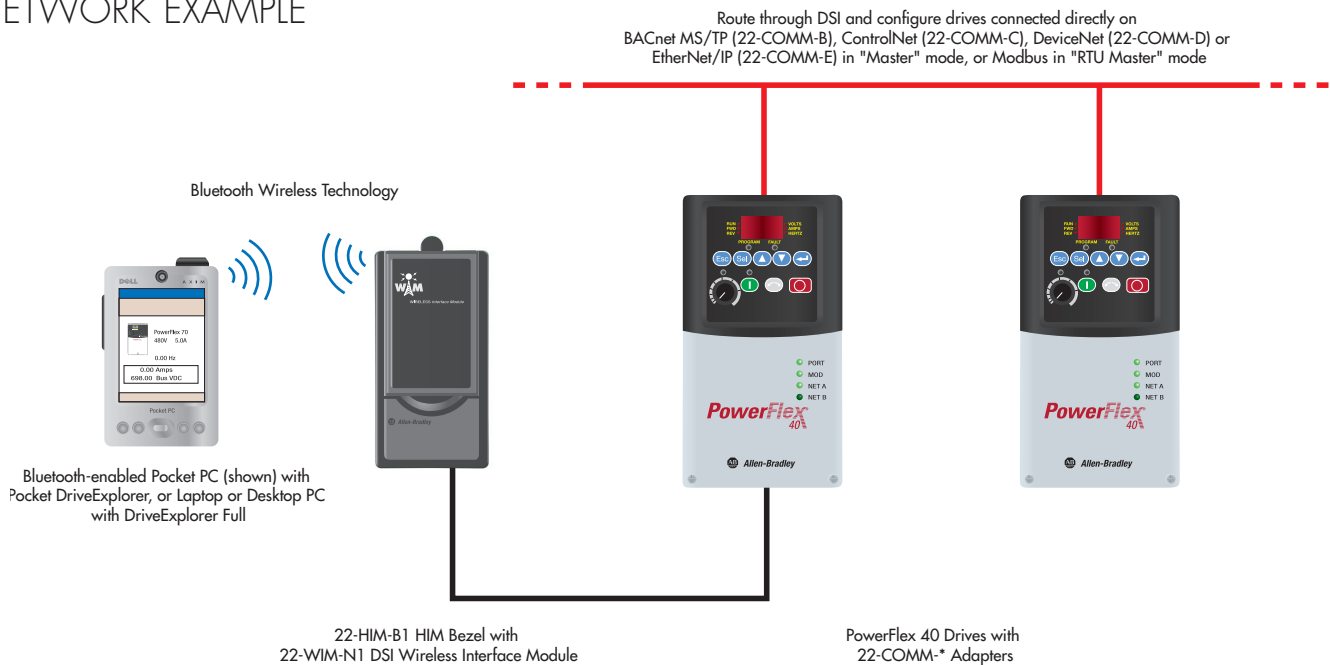

[www.rockwellautomation.com](http://www.rockwellautomation.com)

### Power, Control and Information Solutions Headquarters

Americas: Rockwell Automation, 1201 South Second Street, Milwaukee, WI 53204-2496 USA, Tel: (1) 414.382.2000, Fax: (1) 414.382.4444

Europe/Middle East/Africa: Rockwell Automation, Vorstlaan/Boulevard du Souverain 36, 1170 Brussels, Belgium, Tel: (32) 2 663 0600, Fax: (32) 2 663 0640

Asia Pacific: Rockwell Automation, Level 14, Core F, Cyberport 3, 100 Cyberport Road, Hong Kong, Tel: (852) 2887 4788, Fax: (852) 2508 1846

# PRODUCT PROFILE

## 1203-USB UNIVERSAL SERIAL BUS™ CONVERTER

The 1203-USB Converter provides direct USB connectivity to PowerFlex® 70 (SC or EC), 700 (SC or VC), 700H and 700S drives, PowerFlex 4, 40, 40P and 400 drives, and other DPI-based or DSI-based host devices all-in-one product (combines 1203-SSS & 22-SCM-232 technology). It can also be used with legacy SCANport-based host devices such as Bulletin 1336 PLUS II and 1305 drives. The converter provides a means for drive software tools, such as DriveExplorer™ and DriveTools SP™ (which includes DriveExecutive™ and DriveObserver™), to communicate with drive products.

### PRODUCT HIGHLIGHTS

**External Connection** – The converter connects externally and is powered by the connected drive. No additional power source is required.

**DPI Routing Support** – When connected to a PowerFlex Architecture-Class drive, use DriveExplorer with a 1203-USB converter to route over EtherNet/IP™, ControlNet™, DeviceNet™, or RS-485 DF1 to access other Allen-Bradley drives (1-to-many connection). This eliminates the need for a separate network connection and interface.

**DSI Routing Support** – When connected to a PowerFlex Component-Class drive, use DriveExplorer with a 1203-USB converter to route over EtherNet/IP™, ControlNet™, or DeviceNet™ to access other Allen-Bradley drives (1-to-many connection). Like the 22-SCM-232 module, the converter also has an RTU Master mode. This mode provides connectivity for up to 31 drives via their built-in RS-485 ports. This eliminates the need for a separate network connection and interface.

**Legacy SCANport Connectivity** – Use the 1203-USB converter with DriveExplorer or DriveTools SP (DriveExecutive and DriveObserver) to connect with 1305 and 1336 PLUS II drives, and other SCANport-based host products.



**DriveExplorer Lite/USB Drivers Included** – A CD with DriveExplorer Lite and USB drivers is included with the 1203-USB converter. DriveExplorer Lite is freeware and can also be downloaded at: [http://www.ab.com/drives/driveexplorer/free\\_download.html](http://www.ab.com/drives/driveexplorer/free_download.html)

**Flash Upgradeable** – The 1203-USB converter can be flash updated in the field using DriveExplorer, DriveExecutive or ControlFLASH to take advantage of new firmware features as they become available. The converter is also the primary connection mechanism for flashing drives and other peripherals.

### ACCESSORIES

Do you want to connect to a drive without having to open the enclosure door? The following GracePort™ interface options provide this capability:

#### DPI/SCANport Products

- P-A19-B3 (NEMA 4/12 interface with 8-pin mini-DIN connector)
- P-A19-F3R0 (same as above plus convenience AC outlet)

#### DSI Products

- P-A20-B3 (NEMA 4/12 interface with RJ45 connector)
- P-A20-F3R0 (same as above plus convenience AC outlet)

For more information about these and other related products, please visit Grace Engineered Products Inc. at <http://www.grace-eng.com>

## PARAMETERS (DPI MODE)

No.	Name	Description
01	DPI Port	Displays the port on the host drive which the converter is connected.
02	Reset Module	Resets the converter or sets the converter parameters to factory default.
03	Clear DF1 Counts	Resets the DF1 statistical Parameter 04 - [DF1 Packets Sent] and Parameter 05 - [DF1 Packets Rcvd] to 0 if set to "1 = Clear Counts". This parameter will be reset to "0 = Ready" after a "Clear Counts" command has been performed.
04	DF1 Packets Sent	Displays the number of DF1 packets sent by the converter. This parameter is normally about equal to the value in Parameter 05 - [DF1 Packets Rcvd].
05	DF1 Packets Rcvd	Displays the number of DF1 packets received by the converter. This parameter is normally about equal to the value in Parameter 04 - [DF1 Packets Sent].
06	Interface Mode	Selects whether the converter will autodetect DPI or SCANport devices and use the appropriate protocol.
07	DPI Data Rate	Displays the data rate used by the DPI drive. This data rate is set in the drive, and the converter autobauds to it.
08	Ref/Fdbk Size	Displays the size of the Speed Reference/Feedback words which is determined by the drive. The converter automatically uses the correct size.
09	Datalink Size	Displays the size of each Datalink word which is determined by the drive. The converter automatically uses the correct size.

## PARAMETERS (DSI MODE)

No.	Name	Description
01	Adapter	Cfg Sets the operating mode of the converter.
02	Reset Module	Resets the converter or sets the converter parameters to factory default.
03	Clear DF1 Counts	Resets the DF1 statistical Parameter 04 - [DF1 Packets Sent] and Parameter 05 - [DF1 Packets Rcvd] to 0 if set to "1 = Clear Counts". This parameter will be reset to "0 = Ready" after a "Clear Counts" command has been performed.
04	DF1 Packets Sent	Displays the number of DF1 packets sent by the converter. This parameter is normally about equal to the value in Parameter 05 - [DF1 Packets Rcvd].
05	DF1 Packets Rcvd	Displays the number of DF1 packets received by the converter. This parameter is normally about equal to the value in Parameter 04 - [DF1 Packets Sent].
06	RTU DSI Addr Cfg	Sets the node address of the converter for use with the converter operating mode set with Parameter 01 - [Adapter Cfg].
07	RTU DSI Addr Act	Displays the node address of the drive that the converter is communicating with when the converter is set to RTU Master mode using Parameter 01 - [Adapter Cfg].
08	Adapter Type	Displays the present operating mode of the converter.

## PARAMETERS (SCANport MODE)

No.	Name	Description
01	Adapter Port	Displays the port on the host drive which the converter is connected.
02	Reset Module	Resets the converter or sets the converter parameters to factory default.
03	Clear DF1 Counts	Resets the DF1 statistical Parameter 04 - [DF1 Packets Sent] and Parameter 05 - [DF1 Packets Rcvd] to 0 if set to "1 = Clear Counts". This parameter will be reset to "0 = Ready" after a "Clear Counts" command has been performed.
04	DF1 Packets Sent	Displays the number of DF1 packets sent by the converter. This parameter is normally about equal to the value in Parameter 05 - [DF1 Packets Rcvd].
05	DF1 Packets Rcvd	Displays the number of DF1 packets received by the converter. This parameter is normally about equal to the value in Parameter 04 - [DF1 Packets Sent].
06	RTU DSI Addr Cfg	Selects whether the converter will autodetect DPI or SCANport devices and use the appropriate protocol.

## SPECIFICATIONS

Communications	Network	Protocol Data Rate	USB 115.2 Kbps
	Drive	Protocol Data Rate	DPI 125 or 500 Kbps DSI 19.2 Kbps SCANport 125 Kbps
Electrical	Consumption	Drive	DPI/SCANport 130 mA at 12 VDC DSI 170 mA at 5 VDC
		Network	None
Regulatory Compliance		UL	UL508C
		cUL	CAN/CSA C22.2 No. 14-M91
		CE	EN50178 and EN61800-3
		CTick	AS/NZS 2064, Group 1, Class A

## NETWORK EXAMPLE

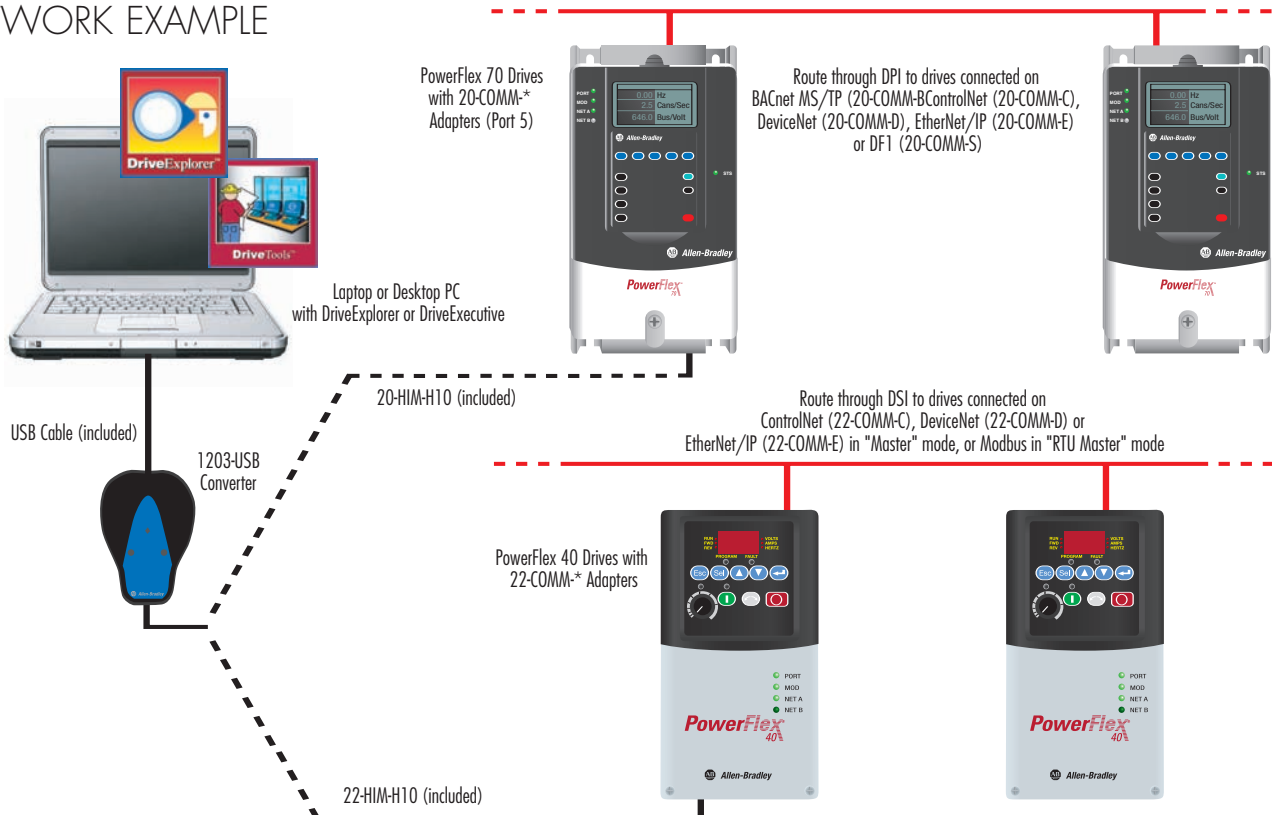

## 4-CLASS CONNECTIVITY

Communication Adapter / Module	Protocol	PowerFlex 4-Class		
		4	40	400
(internal)	Modbus RTU	std.	std.	std.
22-COMM-B	BACnet MS/TP	Y <sup>(1)</sup>	Y	Y
22-SCM-232	DF1	Y	Y	Y
22-COMM-C	ControlNet	Y <sup>(1)</sup>	Y	Y
22-COMM-D	DeviceNet	Y <sup>(1)</sup>	Y	Y
22-COMM-E	EtherNet/IP	Y <sup>(1)</sup>	Y	Y
22-COMM-L	LonWorks	Y <sup>(1)</sup>	Y	Y
22-COMM-P	PROFIBUS DP	Y <sup>(1)</sup>	Y	Y
1769-SM2	DSI Modbus RTU	Y	Y	Y
22-WIM-Nx	Bluetooth	Y	Y	Y
1203-USB	Universal Serial Bus	Y	Y	Y

**Note:** <sup>(1)</sup> Requires use with either a PowerFlex 40 or 400 and installed communication adapter configured for Multi-Drive mode, or a DSI External Communications Kit.

PowerFlex is a registered trademark of Rockwell Automation. DriveExplorer, DPI, DriveExecutive, Remote I/O, and Compact I/O are trademarks of Rockwell Automation. Trademarks not belonging to Rockwell Automation are property of their respective companies.

**[www.rockwellautomation.com](http://www.rockwellautomation.com)**

---

**Power, Control and Information Solutions Headquarters**

Americas: Rockwell Automation, 1201 South Second Street, Milwaukee, WI 53204-2496 USA, Tel: (1) 414.382.2000, Fax: (1) 414.382.4444

Europe/Middle East/Africa: Rockwell Automation, Vorstlaan/Boulevard du Souverain 36, 1170 Brussels, Belgium, Tel: (32) 2 663 0600, Fax: (32) 2 663 0640

Asia Pacific: Rockwell Automation, Level 14, Core F, Cyberport 3, 100 Cyberport Road, Hong Kong, Tel: (852) 2887 4788, Fax: (852) 2508 1846